

VALABIL DE LA 1 APRILIE 2024

**GEBERIT
SISTEME
DE TEVI
CATÁLOG
2024/2025**

**KNOW
HOW
INSTALLED**

Geberit HDPE	7
Sistem convențional de drenaj al acoperișului	43
Instalație pluvială Geberit Pluvia	47
Geberit Silent-db20	65
Geberit Silent-PP	83
Geberit Silent-Pro	101
Ventile de aerisire pentru drenaj	107
Protecție antifoc, izolare acustică și protecție contra umezelii	111
Drenaj prin pardoseală	117
Geberit FlowFit	125
Încălzire și răcire radiantă	161
Geberit Mapress Oțel-Inox	175
Geberit Mapress Oțel-Carbon	207
Geberit Mapress Cupru	237
Geberit Mapress CuNiFe	265
Armături	283
Unelte	291
Anexe	335





Geberit HDPE

Țevi	8
Fitinguri	8
Coturi	8
Ramificații	11
Reducții	16
Piese de curățire	18
Adaptoare	19
Fitinguri speciale	19
Conexiuni	20
Îmbinări prin sudură	20
Îmbinări prin mufare	21
Adaptoare la alte materiale	22
Îmbinări filetate	24
Conexiuni cu flanșă	27
Bucșe de fixare	28
Racorduri de aparate	28
Coturi de conectare	28
Mufe de conectare	30
Ștuțuri de conectare	31
Sifoane tip P	31
Sifoane tip melc	32
Accesorii	32
Brățări pentru conducte	32
Dispozitive de fixare pentru brățări pentru conducte	34
Înveliș portant	37
Dispozitive de închidere	38
Etanșări	39
Casete de protecție	40
Materiale consumabile	40

Tevi

Teavă Geberit HDPE

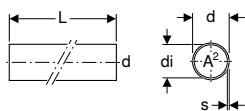
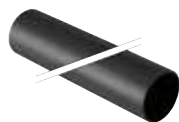

click & scan
EUR/m

Cod art.	DN	d, ø [mm]	di, ø [mm]	s [mm]	L [cm]	L [m]	A² [cm²]	PN [bar]	S	EUR/m
379.000.16.0	30	32	26	3	500	5	5,3	10,3	12,5	3,14
360.000.16.0	40	40	34	3	500	5	9	8,1	12,5	3,73
361.000.16.0	50	50	44	3	500	5	15,2	6,4	12,5	3,89
363.000.16.0	56	56	50	3	500	5	19,6	5,7	12,5	4,34
364.000.16.0	60	63	57	3	500	5	25,4	5	12,5	4,78
365.000.16.0	70	75	69	3	500	5	37,3	4,1	12,5	5,69
366.000.16.0	90	90	83	3,5	500	5	54,1	4	12,5	7,62
367.000.16.0	100	110	101,4	4,3	500	5	80,7	4	12,5	11,47
368.000.16.0	125	125	115,2	4,9	500	5	104,5	4	12,5	14,60
369.000.16.0	150	160	147,6	6,2	500	5	171,1	4	12,5	25,16
370.000.16.0	200	200	187,6	6,2	500	5	276,4	3,2	16	31,54
371.000.16.0	250	250	234,4	7,8	500	5	431,5	3,2	16	53,12
372.000.16.0	300	315	295,4	9,8	500	5	685,3	3,2	16	83,00

Teavă Geberit HDPE PN4

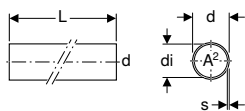
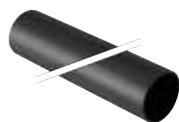

click & scan
EUR/m

Cod art.	DN	d, ø [mm]	di, ø [mm]	s [mm]	L [cm]	L [m]	A² [cm²]	PN [bar]	S	EUR/m
370.050.16.0	200	200	184,6	7,7	500	5	268,4	4	12,5	41,96
371.050.16.0	250	250	230,6	9,7	500	5	418,2	4	12,5	65,15
372.050.16.0	300	315	290,6	12,2	500	5	663,8	4	12,5	101,60

Fitinguri

Coturi

Cot Geberit HDPE

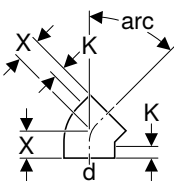

click & scan

Cod art.	DN	d, ø [mm]	X [cm]	K [cm]	EUR/buc.
arc / cot: 45°					
360.045.16.1	40	40	4	2	1,70
361.045.16.1	50	50	4,5	2	1,70
363.045.16.1	56	56	4,5	2	2,53
364.045.16.1	60	63	5	2	2,66
365.045.16.1	70	75	5	2	3,74
366.045.16.1	90	90	5,5	2	5,40
367.045.16.1	100	110	6	2,5	5,54
368.045.16.1	125	125	6,5	2,5	7,69
369.045.16.1	150	160	6,9	2	17,87
370.045.16.1	200	200	18	2,5	39,71
arc / cot: 88,5°					
361.088.16.1	50	50	6	2	1,94
363.088.16.1	56	56	6,5	2	2,53
364.088.16.1	60	63	7	2	3,02



Cod art.	DN	d, ø [mm]	X [cm]	K [cm]	EUR/buc.
365.088.16.1	70	75	7,5	2	3,85
366.088.16.1	90	90	8	2	5,40
367.088.16.1	100	110	9,5	2,5	5,64
368.088.16.1	125	125	10	2,5	10,56
369.088.16.1	150	160	12	2,5	21,35

Cot Geberit HDPE cu umăr lung

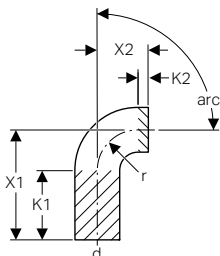

click & scan

Cod art.	DN	d, ø [mm]	X1 [cm]	X2 [cm]	K1 max. [cm]	K2 max. [cm]	r [cm]	EUR/buc.
arc / cot: 45°								
365.046.16.1	70	75	9,1	5	6	2		6,49
367.046.16.1	100	110	14,7	6	11	2,5		7,45
arc / cot: 90°								
379.055.16.1	30	32	10	3	7		3	1,94
360.055.16.1	40	40	15	3	12		3	1,94
361.055.16.1	50	50	18	4	14		4	2,17
363.055.16.1	56	56	21	4	17		4	2,78
364.055.16.1	60	63	21	5	16		5	3,26
365.055.16.1	70	75	21	7	14		7	4,82
366.055.16.1	90	90	24	9	15		9	6,49
367.055.16.1	100	110	27	10	17		10	6,49
368.055.16.1	125	125	20	11	9		11	9,60
369.055.16.1	150	160	20	14	6		14	21,35



- Cotul Geberit PE cu unghiuri de 15°, 30°, 45° și 88.5° pot fi sudate la ambele laturi, cu mufe de electrofuziune Geberit
- Cotul Geberit PE cu un unghi de 90° poate fi sudat la latura lungă, cu mufe de electrofuziune Geberit

Segment de cot Geberit HDPE

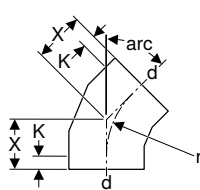

click & scan

Cod art.	DN	d, ø [mm]	X [cm]	K [cm]	r [cm]	EUR/buc.
arc / cot: 15°						
370.015.16.1	200	200	15,5	4		49,72
371.015.16.1	250	250	10,3	0		68,28
372.015.16.1	300	315	10,3	0		80,74
arc / cot: 30°						
370.030.16.1	200	200	15	2	20	51,27
371.030.16.1	250	250	16	0	42	69,24
372.030.16.1	300	315	17	0	47,3	81,81
arc / cot: 45°						
371.045.16.1	250	250	16,5	0	29	67,08
372.045.16.1	300	315	18	0	32,5	83,36
arc / cot: 90°						
370.055.16.1	200	200	30	2,5	20	83,36
371.055.16.1	250	250	33,5	0	29	155,46
372.055.16.1	300	315	37	0	32,5	199,16

Cot 90° Geberit HDPE, fără umăr

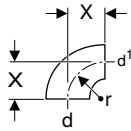

click & scan

Cod art.	DN	d, ø [mm]	d1, ø [mm]	arc [°]	X [cm]	r [cm]	EUR/buc.
361.872.16.1	50 / 40	50	40	90	4	4	1,94
363.873.16.1	56 / 50	56	50	90	4	4	2,78
364.873.16.1	60 / 50	63	50	90	5	5	2,78
364.874.16.1	60 / 56	63	56	90	5	5	3,26

Cot Geberit HDPE BottomTurn

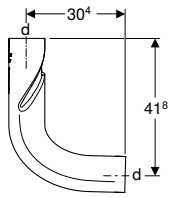

click & scan

Cod art.	Culoare/suprafață	DN	d, ø [mm]	arc [°]	EUR/buc.
367.615.16.1	Negru	100	110	90	86,51

Cot Geberit HDPE BackFlip

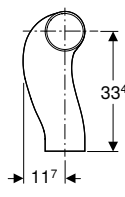
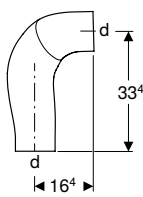

click & scan

Cod art.	Culoare/suprafață	DN	d, ø [mm]	arc [°]	EUR/buc.
367.616.16.1	Negru	100	110	90	39,30



Ramificații

Ramificație 45° Geberit HDPE

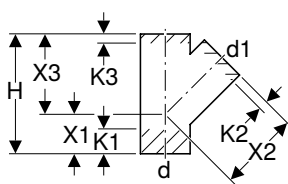

click & scan

Cod art.	DN	d, ø [mm]	d1, ø [mm]	arc [°]	H [cm]	X1 [cm]	X2 [cm]	X3 [cm]	K1 max. [cm]	K2 max. [cm]	K3 max. [cm]	EUR/buc.
379.108.16.1	30 / 30	32	32	45	10,5	3,5	7	7	2	2	2	3,02
360.108.16.1	40 / 30	40	32	45	13,5	4,5	9	9	3	3,5	3,5	3,02
360.109.16.1	40 / 40	40	40	45	13,5	4,5	9	9	2,5	3	3	3,02
361.109.16.1	50 / 40	50	40	45	16,5	5,5	11	11	4	4,5	4,5	3,26
361.112.16.1	50 / 50	50	50	45	16,5	5,5	11	11	3,5	2	2	3,26
363.112.16.1	56 / 50	56	50	45	18	6	12	12	4	3	3	4,06
363.115.16.1	56 / 56	56	56	45	18	6	12	12	4	2,5	2,5	4,06
364.109.16.1	60 / 40	63	40	45	19,5	6,5	13	13	4,5	4,5	4	4,45
364.112.16.1	60 / 50	63	50	45	19,5	6,5	13	13	5	3	3	4,45
364.115.16.1	60 / 56	63	56	45	19,5	6,5	13	13	4,5	2,5	2,5	4,45
364.120.16.1	60 / 60	63	63	45	19,5	6,5	13	13	4	2	2	4,45
365.109.16.1	70 / 40	75	40	45	21	7	14	14	6,5	5	6	5,64
365.112.16.1	70 / 50	75	50	45	21	7	14	14	6	3	4	5,64
365.115.16.1	70 / 56	75	56	45	21	7	14	14	5,5	2,5	3,5	5,64
365.120.16.1	70 / 60	75	63	45	21	7	14	14	4,5	2,5	3,5	5,64
365.125.16.1	70 / 70	75	75	45	21	7	14	14	4	2,5	2,5	5,64
366.109.16.1	90 / 40	90	40	45	24	8	16	16	7,5	5,5	6,5	7,21
366.112.16.1	90 / 50	90	50	45	24	8	16	16	8	4	5	7,21
366.115.16.1	90 / 56	90	56	45	24	8	16	16	7,5	3,5	4,5	7,21
366.120.16.1	90 / 60	90	63	45	24	8	16	16	7	3	4	7,21
366.125.16.1	90 / 70	90	75	45	24	8	16	16	6,5	3	3,5	7,21
366.130.16.1	90 / 90	90	90	45	24	8	16	16	5	2	2	7,21
367.109.16.1	100 / 40	110	40	45	27	9	18	18	9,5	6	7,5	8,29
367.112.16.1	100 / 50	110	50	45	27	9	18	18	9,5	5	5,5	8,29
367.115.16.1	100 / 56	110	56	45	27	9	18	18	9	4	4,5	8,29
367.120.16.1	100 / 60	110	63	45	27	9	18	18	8,5	3,5	4	8,29
367.125.16.1	100 / 70	110	75	45	27	9	18	18	7,5	3	3,5	8,29
367.130.16.1	100 / 90	110	90	45	27	9	18	18	6,5	2,5	3	8,29
367.135.16.1	100 / 100	110	110	45	27	9	18	18	5,5	2	2	8,29
368.120.16.1	125 / 60	125	63	45	30	10	20	20	10,5	4,5	6	11,76
368.125.16.1	125 / 70	125	75	45	30	10	20	20	9,5	4	5	11,76
368.130.16.1	125 / 90	125	90	45	30	10	20	20	8,5	3	3,5	11,76
368.135.16.1	125 / 100	125	110	45	30	10	20	20	7	2,5	2,5	11,76
368.139.16.1	125 / 125	125	125	45	30	10	20	20	6	2	2	11,76
369.125.16.1	150 / 70	160	75	45	37,5	12,5	25	25	13,5	6,5	7,5	39,71
369.130.16.1	150 / 90	160	90	45	37,5	12,5	25	25	12,5	5,5	6,5	39,71
369.135.16.1	150 / 100	160	110	45	37,5	12,5	25	25	11	4,5	5,5	39,71
369.139.16.1	150 / 125	160	125	45	37,5	12,5	25	25	10	4	5	39,71
369.145.16.1	150 / 150	160	160	45	37,5	12,5	25	25	7,5	2,5	2,5	39,71
370.125.16.1	200 / 70	200	75	45	54	18	36	36	8,5	10	2,5	88,04
370.135.16.1	200 / 100	200	110	45	54	18	36	36	7,5	10	0	88,04
370.139.16.1	200 / 125	200	125	45	54	18	36	36	5,5	9	0	88,04
370.145.16.1	200 / 150	200	160	45	54	18	36	36	4	5,5	0	99,53
370.146.16.1	200 / 200	200	200	45	54	18	36	36	0	0	0	125,64
371.135.16.1	250 / 100	250	110	45	66	22	44	44	14	10	7,5	115,23
371.139.16.1	250 / 125	250	125	45	66	22	44	44	13	13	6,5	125,64
371.145.16.1	250 / 150	250	160	45	66	22	44	44	10,5	10	0	136,30
371.146.16.1	250 / 200	250	200	45	66	22	44	44	7,5	0	1,5	146,60
371.147.16.1	250 / 250	250	250	45	66	22	44	44	4	0	0	199,16
372.135.16.1	300 / 100	315	110	45	84	28	56	56	23	20	16	157,14
372.139.16.1	300 / 125	315	125	45	84	28	56	56	21,5	20	14,5	167,56
372.145.16.1	300 / 150	315	160	45	84	28	56	56	19,5	17,5	12,5	173,06
372.146.16.1	300 / 200	315	200	45	84	28	56	56	16,5	5	10	178,21
372.147.16.1	300 / 250	315	250	45	84	28	56	56	13	5,5	6,5	188,63
372.148.16.1	300 / 300	315	315	45	84	28	56	56	8,5	2	2	281,80

Ramificație cot 88,5° Geberit HDPE

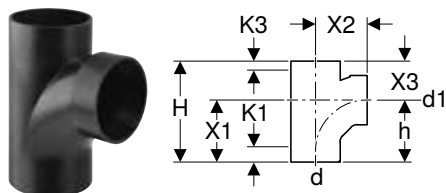

click & scan

Cod art.	DN	d, ø [mm]	d1, ø [mm]	arc [°]	H [cm]	h [cm]	X1 [cm]	X2 [cm]	X3 [cm]	K1 max. [cm]	K3 max. [cm]	EUR/buc.
367.163.16.1	100 / 100	110	110	88,5	22,5	13,8	13,5	11,5	9	2,5	0	8,46

Ramificație 88,5° Geberit HDPE

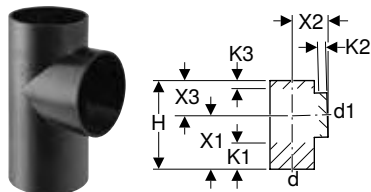

click & scan

Cod art.	DN	d, ø [mm]	d1, ø [mm]	arc [°]	H [cm]	X1 [cm]	X2 [cm]	X3 [cm]	K1 max. [cm]	K2 max. [cm]	K3 max. [cm]	EUR/buc.
379.158.16.1	30 / 30	32	32	88,5	8,5	5	3,5	3,5	2,5	1	1	3,02
360.158.16.1	40 / 30	40	32	88,5	13	7,5	5,5	5,5	5	2,5	2	3,02
360.159.16.1	40 / 40	40	40	88,5	13	7,5	5,5	5,5	4,5	2,5	2,5	3,02
361.159.16.1	50 / 40	50	40	88,5	15	9	6	6	6	2,5	3	3,26
361.162.16.1	50 / 50	50	50	88,5	15	9	6	6	5,5	2,5	2,5	3,26
363.162.16.1	56 / 50	56	50	88,5	17,5	10,5	7	7	7	3	3,5	3,98
363.165.16.1	56 / 56	56	56	88,5	17,5	10,5	7	7	6,5	3	3	3,98
364.159.16.1	60 / 40	63	40	88,5	17,5	10,5	7	7	7	3	3	4,82
364.162.16.1	60 / 50	63	50	88,5	17,5	10,5	7	7	7	3	3,5	4,82
364.165.16.1	60 / 56	63	56	88,5	17,5	10,5	7	7	6,5	3	3	4,82
364.170.16.1	60 / 60	63	63	88,5	17,5	10,5	7	7	6	3	3	4,82
365.159.16.1	70 / 40	75	40	88,5	17,5	10,5	7	7	7,5	2,5	4	5,64
365.162.16.1	70 / 50	75	50	88,5	17,5	10,5	7	7	7	2,5	3,5	5,64
365.165.16.1	70 / 56	75	56	88,5	17,5	10,5	7	7	6,5	2,5	3	5,64
365.170.16.1	70 / 60	75	63	88,5	17,5	10,5	7	7	6	2,5	2,5	5,64
365.175.16.1	70 / 70	75	75	88,5	17,5	10,5	7	7	5,5	2,5	2,5	5,64
366.159.16.1	90 / 40	90	40	88,5	20	12	8	8	8,5	2,5	4,5	7,21
366.162.16.1	90 / 50	90	50	88,5	20	12	8	8	8,5	2,5	4,5	7,21
366.165.16.1	90 / 56	90	56	88,5	20	12	8	8	8	2,5	4	7,21
366.170.16.1	90 / 60	90	63	88,5	20	12	8	8	7,5	2,5	3,5	7,21
366.175.16.1	90 / 70	90	75	88,5	20	12	8	8	7	2,5	3	7,21
366.180.16.1	90 / 90	90	90	88,5	20	12	8	8	6,5	2,5	2,5	7,21
367.159.16.1	100 / 40	110	40	88,5	22,5	13,5	9	9	10	2,5	6	8,46
367.162.16.1	100 / 50	110	50	88,5	22,5	13,5	9	9	9,5	2,5	5	8,46
367.165.16.1	100 / 56	110	56	88,5	22,5	13,5	9	9	9	2,5	4,5	8,46
367.170.16.1	100 / 60	110	63	88,5	22,5	13,5	9	9	9	2,5	4	8,46
367.175.16.1	100 / 70	110	75	88,5	22,5	13,5	9	9	8,5	2,5	3,5	8,46
367.180.16.1	100 / 90	110	90	88,5	22,5	13,5	9	9	7,5	2,5	3	8,46
367.185.16.1	100 / 100	110	110	88,5	22,5	13,5	9	9	6,5	2	2	8,46
368.162.16.1	125 / 50	125	50	88,5	25	15	10	10	11	2,5	6	11,76
368.165.16.1	125 / 56	125	56	88,5	25	15	10	10	10,5	2,5	5,5	11,76
368.170.16.1	125 / 60	125	63	88,5	25	15	10	10	10,5	2,5	5	11,76
368.175.16.1	125 / 70	125	75	88,5	25	15	10	10	10	2,5	4,5	11,76
368.180.16.1	125 / 90	125	90	88,5	25	15	10	10	9	2,5	4	11,76
368.185.16.1	125 / 100	125	110	88,5	25	15	10	10	8	2	3	11,76
368.189.16.1	125 / 125	125	125	88,5	25	15	10	10	7	2	2	11,76
369.175.16.1	150 / 70	160	75	88,5	35	21	14	14	15	4,5	8	36,66
369.185.16.1	150 / 100	160	110	88,5	35	21	14	14	13,5	4,5	6	36,66
369.189.16.1	150 / 125	160	125	88,5	35	21	14	14	12,5	4,5	5	36,66
369.195.16.1	150 / 150	160	160	88,5	35	21	14	14	10,5	3,5	3	36,66
370.180.16.1	200 / 90	200	90	88,5	36	18	18	18	0	3	0	80,84
370.185.16.1	200 / 100	200	110	88,5	36	18	18	18	0	3	0	80,84
370.189.16.1	200 / 125	200	125	88,5	36	18	18	18	0	3	0	80,84
370.195.16.1	200 / 150	200	160	88,5	36	18	18	18	0	2	0	80,84



Cod art.	DN	d, ø [mm]	d1, ø [mm]	arc [°]	H [cm]	X1 [cm]	X2 [cm]	X3 [cm]	K1 max. [cm]	K2 max. [cm]	K3 max. [cm]	EUR/buc.
370.196.16.1	200 / 200	200	200	88,5	40	20	20	20	0	0	0	80,84
371.185.16.1	250 / 100	250	110	88,5	44	22	22	22	3,5	4	3,5	110,19
371.189.16.1	250 / 125	250	125	88,5	44	22	22	22	3	4	3	115,23
371.195.16.1	250 / 150	250	160	88,5	44	22	22	22	0	3,5	0	115,23
371.196.16.1	250 / 200	250	200	88,5	48	24	24	24	0	0	0	120,49
371.197.16.1	250 / 250	250	250	88,5	48	24	24	24	0	0	0	125,64
372.185.16.1	300 / 100	315	110	88,5	56	28	28	28	9,5	6	9,5	157,14
372.189.16.1	300 / 125	315	125	88,5	56	28	28	28	9	6	9	167,56
372.195.16.1	300 / 150	315	160	88,5	56	28	28	28	7	6	7	167,56
372.196.16.1	300 / 200	315	200	88,5	56	28	28	28	4,5	0	4,5	167,56
372.197.16.1	300 / 250	315	250	88,5	56	28	28	28	2	0	2	188,63
372.198.16.1	300 / 300	315	315	88,5	56	28	28	28	0	0	0	209,59

Ramificație 45° Geberit HDPE, dublă

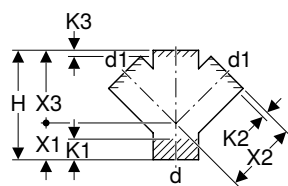

click & scan

Cod art.	DN	d, ø [mm]	d1, ø [mm]	arc [°]	H [cm]	X1 [cm]	X2 [cm]	X3 [cm]	K1 max. [cm]	K2 max. [cm]	K3 max. [cm]	EUR/buc.
367.209.16.1	100 / 40	110	40	45	27	9	18	18	9,5	6	7,5	16,31
367.212.16.1	100 / 50	110	50	45	27	9	18	18	9,5	6	7,5	16,31
367.235.16.1	100 / 100	110	110	45	27	9	18	18	5	1,5	1,5	16,31

Ramificație dublă tip sferă la 88,5° Geberit HDPE, racorduri la 90°

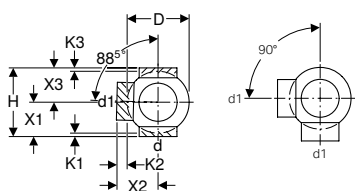

click & scan

Cod art.	DN	d, ø [mm]	d1, ø [mm]	arc [°]	arc2 [°]	D [cm]	H [cm]	X1 [cm]	X2 [cm]	X3 [cm]	K1 max. [cm]	K2 max. [cm]	K3 max. [cm]	EUR/buc.
364.320.16.1	60 / 60	63	63	88,5	90	10	16	8	10	8	1,5	4,5	1,5	13,44
365.325.16.1	70 / 70	75	75	88,5	90	12	16	8	10	8	1,5	3,5	1,5	13,91
366.330.16.1	90 / 90	90	90	88,5	90	14	18	9	11	9	2	4	2	17,38
367.315.16.1	100 / 56	110	56	88,5	90	17	20	10	12	10	1,5	1,5	1,5	21,40
367.320.16.1	100 / 60	110	63	88,5	90	17	20	10	12	10	1,5	1,5	1,5	21,40
367.325.16.1	100 / 70	110	75	88,5	90	17	20	10	12	10	1,5	1,5	1,5	21,40
367.330.16.1	100 / 90	110	90	88,5	90	17	20	10	12	10	1,5	1,5	1,5	21,40
367.335.16.1	100 / 100	110	110	88,5	90	17	20	10	12	10	1,5	4	1,5	21,40
368.335.16.1	125 / 100	125	110	88,5	90	18	20	10	12,5	10	1,5	4	1,5	26,85
369.335.16.1	150 / 100	160	110	88,5	90	23	25	12,5	16	12,5	2	1,5	2	52,47

Ramificație dublă tip sferă la 88,5° Geberit HDPE, racorduri la 135°

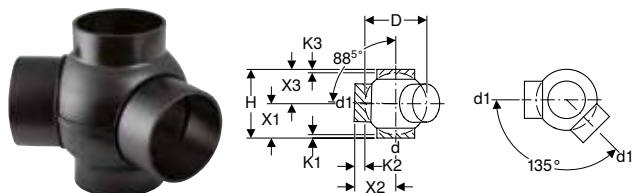

click & scan

Cod art.	DN	d, ø [mm]	d1, ø [mm]	arc [°]	arc2 [°]	D [cm]	H [cm]	X1 [cm]	X2 [cm]	X3 [cm]	K1 max. [cm]	K2 max. [cm]	K3 max. [cm]	EUR/buc.
364.370.16.1	60 / 60	63	63	88,5	135	10	16	8	10	8	1,5	4,5	1,5	13,44
365.375.16.1	70 / 70	75	75	88,5	135	12	16	8	10	8	1,5	3,5	1,5	13,91
366.380.16.1	90 / 90	90	90	88,5	135	14	18	9	11	9	2	4	2	17,38
367.362.16.1	100 / 40	110	50	88,5	135	17	20	10	12	10	1,5	1,5	1,5	30,44
367.365.16.1	100 / 56	110	56	88,5	135	17	20	10	12	10	1,5	1,5	1,5	21,40
367.370.16.1	100 / 60	110	63	88,5	135	17	20	10	12	10	1,5	1,5	1,5	21,40
367.375.16.1	100 / 70	110	75	88,5	135	17	20	10	12	10	1,5	1,5	1,5	21,40
367.380.16.1	100 / 90	110	90	88,5	135	17	20	10	12	10	1,5	1,5	1,5	21,40
367.385.16.1	100 / 100	110	110	88,5	135	17	20	10	12	10	1,5	4	1,5	21,40
368.385.16.1	125 / 100	125	110	88,5	135	18	20	10	12,5	10	1,5	4	1,5	26,85
369.385.16.1	150 / 100	160	110	88,5	135	23	25	12,5	16	12,5	2	1,5	2	52,47

Ramificație dublă tip sferă la 88,5° Geberit HDPE, racorduri la 180°

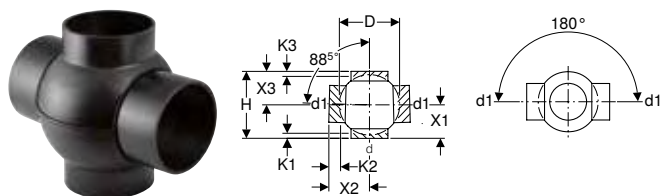

click & scan

Cod art.	DN	d, ø [mm]	d1, ø [mm]	arc [°]	arc2 [°]	D [cm]	H [cm]	X1 [cm]	X2 [cm]	X3 [cm]	K1 max. [cm]	K2 max. [cm]	K3 max. [cm]	EUR/buc.
364.270.16.1	60 / 60	63	63	88,5	180	10	16	8	10	8	1,5	4,5	1,5	13,44
365.275.16.1	70 / 70	75	75	88,5	180	12	16	8	10	8	1,5	3,5	1,5	13,91
366.280.16.1	90 / 90	90	90	88,5	180	14	18	9	11	9	2	4	2	17,38
367.262.16.1	100 / 40	110	50	88,5	180	17	20	10	12	10	1,5	1,5	1,5	26,37
367.265.16.1	100 / 56	110	56	88,5	180	17	20	10	12	10	1,5	1,5	1,5	26,37
367.270.16.1	100 / 60	110	63	88,5	180	17	20	10	12	10	1,5	1,5	1,5	26,37
367.275.16.1	100 / 70	110	75	88,5	180	17	20	10	12	10	1,5	1,5	1,5	26,37
367.280.16.1	100 / 90	110	90	88,5	180	17	20	10	12	10	1,5	1,5	1,5	26,37
367.285.16.1	100 / 100	110	110	88,5	180	17	20	10	12	10	1,5	4	1,5	21,40
368.285.16.1	125 / 100	125	110	88,5	180	18	20	10	12,5	10	1,5	4	1,5	26,85
369.285.16.1	150 / 100	160	110	88,5	180	23	25	12,5	16	12,5	2	1,5	2	52,47

Ramificație triplă tip sferă la 88,5° Geberit HDPE, racorduri la 90°

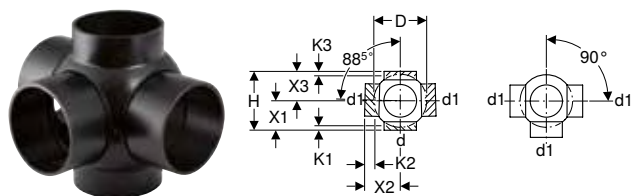

click & scan

Cod art.	DN	d, ø [mm]	d1, ø [mm]	arc [°]	arc2 [°]	D [cm]	H [cm]	X1 [cm]	X2 [cm]	X3 [cm]	K1 max. [cm]	K2 max. [cm]	K3 max. [cm]	EUR/buc.
364.605.16.1	60 / 60	63	63	88,5	90	10	16	8	10	8	1,5	4,5	1,5	20,02
365.605.16.1	70 / 70	75	75	88,5	90	12	16	8	10	8	1,5	3,5	1,5	20,02
366.605.16.1	80 / 80	90	90	88,5	90	14	18	9	11	9	2	4	2	20,02
367.605.16.1	100 / 100	110	110	88,5	90	17	20	10	12	10	1,5	4	1,5	27,39
368.605.16.1	125 / 100	125	110	88,5	90	18	20	10	12	10	1,5	4	1,5	36,19
369.605.16.1	150 / 100	160	110	88,5	90	23	25	12,5	16	12,5	2	1,5	2	56,66



Ramificație triplă tip sferă la 88,5° Geberit HDPE, racorduri la 135°

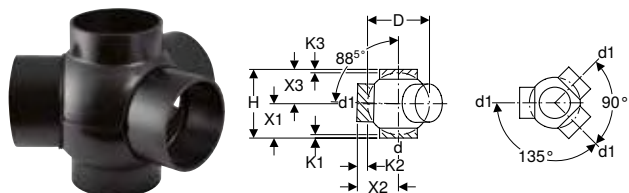

click & scan

Cod art.	DN	d, ø [mm]	d1, ø [mm]	arc [°]	arc2 [°]	D [cm]	H [cm]	X1 [cm]	X2 [cm]	X3 [cm]	K1 max. [cm]	K2 max. [cm]	K3 max. [cm]	EUR/buc.
364.600.16.1	60 / 60	63	63	88,5	135	10	16	8	10	8	1,5	4,5	1,5	19,07
365.600.16.1	70 / 70	75	75	88,5	135	12	16	8	10	8	1,5	3,5	1,5	40,99
367.600.16.1	100 / 100	110	110	88,5	135	17	20	10	12	10	1,5	4	1,5	26,85
368.600.16.1	125 / 100	125	110	88,5	135	18	20	10	12	10	1,5	4	1,5	36,19

Ramificație cu patru elemente tip sferă la 88,5° Geberit HDPE, racorduri la 90°

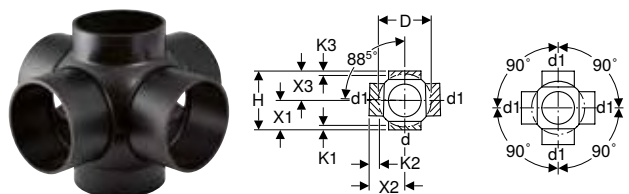

click & scan

Cod art.	DN	d, ø [mm]	d1, ø [mm]	arc [°]	arc2 [°]	D [cm]	H [cm]	X1 [cm]	X2 [cm]	X3 [cm]	K1 max. [cm]	K2 max. [cm]	K3 max. [cm]	EUR/buc.
364.610.16.1	60 / 60	63	63	88,5	90	10	16	8	10	8	1,5	4,5	1,5	20,02
365.610.16.1	70 / 70	75	75	88,5	90	12	16	8	10	8	1,5	3,5	1,5	29,35
367.610.16.1	100 / 100	110	110	88,5	90	17	20	10	12	10	1,5	4	1,5	29,97
368.610.16.1	125 / 100	125	110	88,5	90	18	20	10	12,5	10	1,5	4	1,5	40,99
369.610.16.1	150 / 100	160	110	88,5	90	23	25	12,5	16	12,5	2	1,5	2	56,07

Ramificație 88,5° Geberit HDPE, din patru elemente

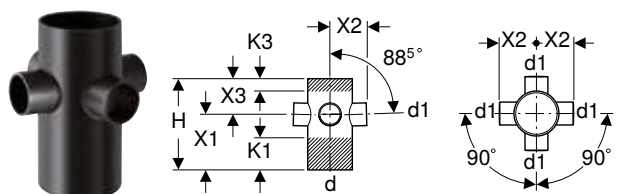

click & scan

Cod art.	DN	d, ø [mm]	d1, ø [mm]	arc [°]	H [cm]	X1 [cm]	X2 [cm]	X3 [cm]	K1 max. [cm]	K3 max. [cm]	EUR/buc.
367.445.16.1	100 / 56	110	56	88,5	22,5	13,5	9	9	7,5	3	30,44

Ramificație pantalon 2 x 30° Geberit HDPE

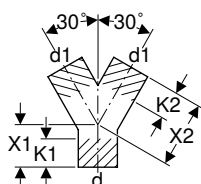

click & scan

Cod art.	DN	d, ø [mm]	d1, ø [mm]	arc [°]	X1 [cm]	X2 [cm]	K1 max. [cm]	K2 max. [cm]	EUR/buc.
361.459.16.1	50 / 40	50	40	30	5,5	11	4	5	4,57
361.462.16.1	50 / 50	50	50	30	5,5	11	3	4	4,57
363.462.16.1	56 / 50	56	50	30	6	12	4	5	6,49
363.465.16.1	56 / 56	56	56	30	1,8	5,3	0	0	6,49
364.462.16.1	60 / 50	63	50	30	6,5	13	5	6	6,49
364.465.16.1	60 / 56	63	56	30	6,5	13	4	6	6,49
365.465.16.1	70 / 56	75	56	30	7	14	6	7	10,56
365.470.16.1	70 / 60	75	63	30	7	14	5	6	10,56
367.480.16.1	100 / 90	110	90	30	9	18	7	7	16,78
367.481.16.1	100 / 100	110	110	30	9	10,2	5	0	16,78

Ramificație pantalon 2 x 90° Geberit Silent-db20

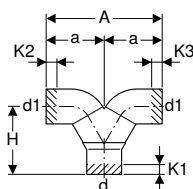

click & scan

Cod art.	DN	d, ø [mm]	d1, ø [mm]	arc [°]	A [cm]	a [cm]	H [cm]	K1 max. [cm]	K2 max. [cm]	K3 max. [cm]	EUR/buc.
308.480.14.1	90 / 90	90	90	90	30	15	17,5	4	2	2	110,19
310.481.14.1	100 / 90	110	90	90	30	15	17,5	4	2	2	116,99

Reducții

Reducție excentrică Geberit HDPE, scurtă

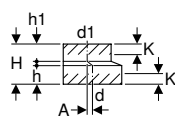

click & scan

Cod art.	DN	d, ø [mm]	d1, ø [mm]	A [cm]	H [cm]	h [cm]	h1 [cm]	K [cm]	EUR/buc.
361.558.16.1	50 / 40	50	40	0,5	8	3,5	3,7	2	2,17
363.558.16.1	56 / 40	56	40	0,8	8	3,5	3,7	2	2,42
363.561.16.1	56 / 50	56	50	0,3	8	3,5	3,7	2	2,42
364.558.16.1	60 / 40	63	40	1,2	8	3,5	3,7	2	2,53
364.561.16.1	60 / 50	63	50	0,7	8	3,5	3,7	2	2,53
364.566.16.1	60 / 56	63	56	0,4	8	3,5	3,7	2	2,53
365.558.16.1	70 / 40	75	40	1,8	8	3,5	3,7	2	2,53
365.561.16.1	70 / 50	75	50	1,3	8	3,5	3,7	2	2,53
365.566.16.1	70 / 56	75	56	1	8	3,5	3,7	2	2,53
365.571.16.1	70 / 60	75	63	0,6	8	3,5	3,7	2	2,53
366.561.16.1	90 / 50	90	50	2	8	3,5	3,7	2	2,53
366.566.16.1	90 / 56	90	56	1,7	8	3,5	3,7	2	2,53
366.571.16.1	90 / 60	90	63	1,3	8	3,5	3,7	2	2,53
366.576.16.1	90 / 70	90	75	0,8	8	3,5	3,7	2	2,53
367.558.16.1	100 / 40	110	40	3,4	8	3,5	3,7	2	2,78
367.561.16.1	100 / 50	110	50	2,9	8	3,5	3,7	2	2,78
367.566.16.1	100 / 56	110	56	2,6	8	3,5	3,7	2	2,78
367.571.16.1	100 / 60	110	63	2,2	8	3,5	3,7	2	2,78
367.576.16.1	100 / 70	110	75	1,6	8	3,5	3,7	2	2,78
367.581.16.1	100 / 90	110	90	0,9	8	3,5	3,7	2	2,78



Cod art.	DN	d, ø [mm]	d1, ø [mm]	A [cm]	H [cm]	h [cm]	h1 [cm]	K [cm]	EUR/buc.
368.561.16.1	125 / 50	125	50	3,6	8	3,5	3,7	2	5,76
368.566.16.1	125 / 56	125	56	3,3	8	3,5	3,7	2	5,76
368.571.16.1	125 / 60	125	63	2,9	8	3,5	3,7	2	5,76
368.576.16.1	125 / 70	125	75	2,3	8	3,5	3,7	2	5,76
368.581.16.1	125 / 90	125	90	1,6	8	3,5	3,7	2	5,76
368.586.16.1	125 / 100	125	110	0,7	8	3,5	3,7	2	5,76
369.586.16.1	150 / 100	160	110	2,3	8	3,5	3,7	2	7,10
369.588.16.1	150 / 125	160	125	1,6	8	3,5	3,7	2	7,10
369.591.16.1	150 / 140	160	140	1	8	3,5	3,7	2	7,10

Reducție excentrică Geberit HDPE, lungă

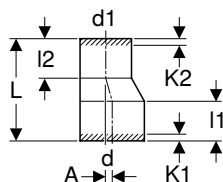

click & scan

Cod art.	DN	d, ø [mm]	d1, ø [mm]	A [cm]	L [cm]	I1 [cm]	I2 [cm]	K1 max. [cm]	K2 max. [cm]	EUR/buc.
368.584.16.1	125 / 100	125	110	0,7	16	7	6,4	4	3	14,64
369.584.16.1	150 / 100	160	110	2,5	28	9,4	6,4	6	3	41,94
369.587.16.1	150 / 125	160	125	1,7	24	9,4	8	6	5	41,69
370.584.16.5	200 / 100	200	110	4,3	28	11,5	3,7	4	0	57,74
370.587.16.5	200 / 125	200	125	3,6	28	11,5	3,7	4	0	57,74
370.594.16.5	200 / 150	200	160	2	28	11,9	9,1	4	6	59,89
371.596.16.1	250 / 200	250	200	2,5	40,5	15,8	15,7	8	8	86,60
372.596.16.1	300 / 200	315	200	5,7	58	16,1	15,7	8	8	141,44
372.598.16.1	300 / 250	315	250	3,2	43,5	16,1	15,7	8	8	141,44

Reducție centrică Geberit HDPE, scurtă

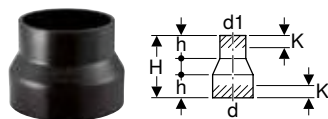

click & scan
EUR/buc.

Cod art.	DN	d, ø [mm]	d1, ø [mm]	H [cm]	h [cm]	K [cm]	EUR/buc.
360.557.16.1	40 / 30	40	32	8	3	1,5	1,94
361.557.16.1	50 / 30	50	32	8	3	1,5	2,17
361.559.16.1	50 / 40	50	40	8	3	1,5	2,17
363.559.16.1	56 / 40	56	40	8	3	1,5	2,42
363.560.16.1	56 / 50	56	50	8	3	1,5	2,42
364.559.16.1	60 / 40	63	40	8	3	1,5	2,53
364.560.16.1	60 / 50	63	50	8	3	1,5	2,53
364.565.16.1	60 / 56	63	56	8	3	1,5	2,53
365.559.16.1	70 / 40	75	40	8	3	1,5	2,53
365.560.16.1	70 / 50	75	50	8	3	1,5	2,53
365.565.16.1	70 / 56	75	56	8	3	1,5	2,53
365.570.16.1	70 / 60	75	63	8	3	1,5	2,53
366.559.16.1	90 / 40	90	40	8	3	1,5	2,53
366.560.16.1	90 / 50	90	50	8	3	1,5	2,53
366.565.16.1	90 / 56	90	56	8	3	1,5	2,53
366.570.16.1	90 / 60	90	63	8	3	1,5	2,53
366.575.16.1	90 / 70	90	75	8	3	1,5	2,53
367.559.16.1	100 / 40	110	40	8	3	1,5	2,78
367.560.16.1	100 / 50	110	50	8	3	1,5	2,78
367.565.16.1	100 / 56	110	56	8	3	1,5	2,78
367.570.16.1	100 / 60	110	63	8	3	1,5	2,78
367.575.16.1	100 / 70	110	75	8	3	1,5	2,78
367.580.16.1	100 / 90	110	90	8	3	1,5	2,78
368.570.16.1	125 / 60	125	63	8	3	1,5	5,76
368.575.16.1	125 / 70	125	75	8	3	1,5	5,76
368.580.16.1	125 / 90	125	90	8	3	1,5	5,76
368.585.16.1	125 / 100	125	110	8	3	1,5	5,76
369.535.16.1	150 / 100	160	110	4	0,6	0	7,10

Piese de curățire

Piesă de curățare 45° Geberit HDPE cu orificiu de service rotund

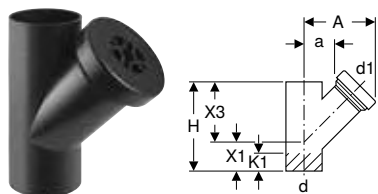

click & scan

Cod art.	DN	d, ø [mm]	d1, ø [mm]	arc [°]	A [cm]	a [cm]	H [cm]	X1 [cm]	X3 [cm]	K1 max. [cm]	EUR/buc.
367.453.16.1	100 / 100	110	110	45	19,5	6,5	27	9	18	5,5	25,29
368.453.16.1	125 / 100	125	110	45	20	7	30	10	20	7	35,22
369.453.16.1	150 / 100	160	110	45	22	9	37,5	12,5	25	11	62,17

Piesă de curățare 90° Geberit HDPE cu orificiu de service rotund

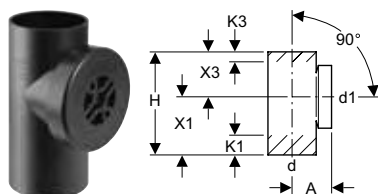

click & scan

Cod art.	DN	d, ø [mm]	d1, ø [mm]	arc [°]	A [cm]	H [cm]	X1 [cm]	X3 [cm]	K1 max. [cm]	K3 max. [cm]	EUR/buc.
364.451.16.1	60 / 60	63	63	90	9	17,5	10,5	7	4,5	0	15,36
365.451.16.1	70 / 70	75	75	90	9,5	17,5	10,5	7	3,5	0	17,87



Cod art.	DN	d, ø [mm]	d1, ø [mm]	arc [°]	A [cm]	H [cm]	X1 [cm]	X3 [cm]	K1 max. [cm]	K3 max. [cm]	EUR/buc.
366.451.16.1	90 / 90	90	90	90	11	20	12	8	3	0	20,98
367.451.16.1	100 / 100	110	110	90	9	24	13,5	10,5	4,5	0	24,81
368.451.16.1	125 / 100	125	110	90	13	25	15	10	6	1	30,44
369.451.16.1	150 / 100	160	110	90	15	35	21	14	12	4	54,50

Piesă de curățare 90° Geberit HDPE cu orificiu de service oval

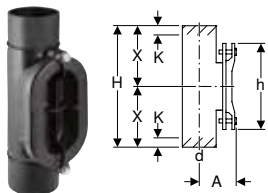

click & scan

Cod art.	DN	d, ø [mm]	arc [°]	A [cm]	H [cm]	h [cm]	X [cm]	K [cm]	EUR/buc.
367.454.16.1	100	110	90	12	40	28	20	3	120,49
368.454.16.1	125	125	90	12,5	41	28	20,5	4	163,48
369.454.16.1	150	160	90	14	43	28	21,5	4	200,86
370.454.16.1	200	200	90	17,5	65	38	32,5	5,5	360,12
371.454.16.1	250	250	90	20	58	38	29	3	482,88
372.454.16.1	300	315	90	23	62	38	31	8	607,40

Adaptoare

Mufă de adaptare Geberit HDPE



click & scan

Cod art.	DN	d1, ø [mm]	d2, ø [mm]	EUR/buc.
367.928.16.1	90 / 100	90	110	7,69

Fitinguri speciale

Fiting Geberit HDPE Sovent

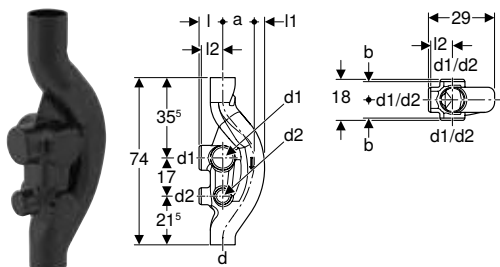

click & scan

Cod art.	DN	d, ø [mm]	d1, ø [mm]	d2, ø [mm]	a [cm]	l [cm]	l1 [cm]	l2 [cm]	b [cm]	EUR/buc.
367.614.16.1	100 / 100 / 70	110	110	75	13	10,5	5,5	9,5	8	54,26

Fiting Geberit HDPE Sovent

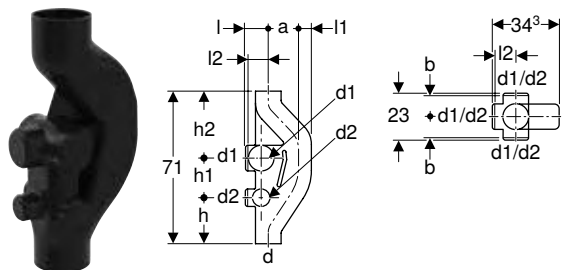

click & scan

Cod art.	DN	d, ø [mm]	d1, ø [mm]	d2, ø [mm]	a [cm]	l [cm]	l1 [cm]	l2 [cm]	b [cm]	h [cm]	h2 [cm]	h1 [cm]	EUR/buc.
369.001.16.1	150 / 100 / 70	160	110	75	13,3	13	8	11	9,5	19	35	17	68,76

Element ventilare Geberit HDPE

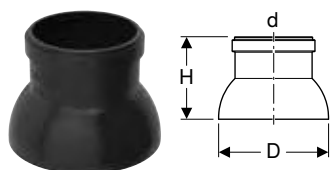

click & scan

Cod art.	Culoare/suprafață	DN	d, ø [mm]	D [cm]	H [cm]	EUR/buc.
364.989.16.2	Negru	60	63	10	8,7	15,71
365.989.16.2	Negru	70	75	12	10,1	16,43
366.989.16.2	Negru	90	90	14	11,4	17,38
367.989.16.2	Negru	100	110	17	12,8	19,79
368.989.16.2	Negru	125	125	18	13,1	26,24
369.989.16.2	Negru	150	160	23	16,7	57,50

Colector de ape reziduale Geberit HDPE

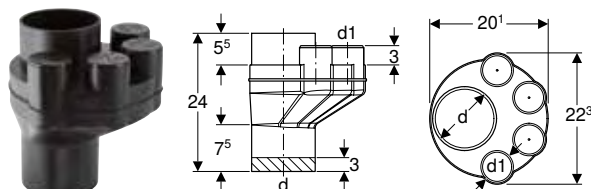

click & scan

Cod art.	DN	d, ø [mm]	d1, ø [mm]	EUR/buc.
367.612.16.1	100 / 56	110	56	52,47

Conexiuni

Îmbinări prin sudură

Mufă de electrofuziune Geberit



click & scan

Cod art.	DN	d, ø [mm]	D [cm]	E [cm]	H [cm]	X [cm]	EUR/buc.
360.771.16.1	40	40	5,2	2,8	6	0,3	5,05
361.771.16.1	50	50	6,2	2,8	6	0,3	5,05
363.771.16.1	56	56	6,8	2,8	6	0,3	5,64
364.771.16.1	60	63	7,6	2,8	6	0,3	6,13



Cod art.	DN	d, ø [mm]	D [cm]	E [cm]	H [cm]	X [cm]	EUR/buc.
365.771.16.1	70	75	8,9	2,8	6	0,3	6,73
366.771.16.1	90	90	10,4	2,8	6	0,3	7,21
367.771.16.1	100	110	12,5	2,8	6	0,3	8,40
368.771.16.1	125	125	14,2	2,8	6	0,3	10,07
369.771.16.1	150	160	17,8	2,8	6	0,3	12,24

Mufă de electrofuziune cu fuzibil termic integrat Geberit HDPE

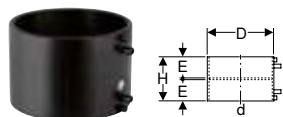

click & scan
EUR/buc.

Cod art.	DN	d, ø [mm]	D [cm]	E [cm]	H [cm]	EUR/buc.
370.775.16.1	200	200	22,4	7,5	15	103,50
371.775.16.1	250	250	27,5	7,5	15	131,03
372.775.16.1	300	315	34,3	7,5	15	197,01

Accesorii

- Set de accesorii Geberit pentru sudare termică a mufelor de electrofuziune cu fuzibil termic integrat → p. 292

Îmbinări prin mufare

Mufă de dilatație Geberit HDPE cu colier dublu

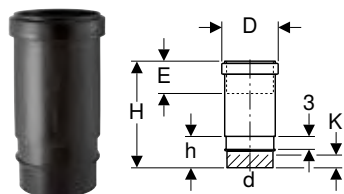

click & scan

Cod art.	DN	d, ø [mm]	D [cm]	E [cm]	I [cm]	H [cm]	h [cm]	K [cm]	EUR/buc.
379.791.16.1	30	32	4,6	3,5-7	3	12,8	3,9	0	7,93
360.700.16.1	40	40	5,5	6,5-13	3	23,7	6,8	3	10,07
361.700.16.1	50	50	6,7	6,5-13	3	24	6,8	3	10,07
363.700.16.1	56	56	7,4	6,5-13	3	24	6,8	3	10,07
364.700.16.1	60	63	8,3	7-13,5	3	24,3	6,8	3	10,28
365.700.16.1	70	75	9,7	7-13,5	3	24,6	6,8	3	11,03
366.700.16.1	90	90	11,3	7-13,5	3	24,9	6,9	3	11,03
367.700.16.1	100	110	13,6	7,5-14	3	25,6	7,3	3,5	11,03
368.700.16.1	125	125	15,7	8-14,5	3	26,1	7,4	3,5	19,07
369.700.16.1	150	160	19,5	8-14,5	3	26,8	7,4	3,5	26,85

Mufă de dilatație Geberit HDPE

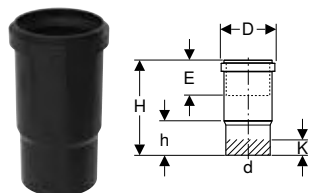

click & scan

Cod art.	DN	d, ø [mm]	D [cm]	E [cm]	H [cm]	h [cm]	K [cm]	EUR/buc.
370.700.16.1	200	200	24,3	17-23,5	43	15,6	13	120,02
371.700.16.1	250	250	29,1	17-23,5	42,5	17	14	191,75
372.700.16.1	300	315	36,1	17-23,5	45,8	17,5	14	345,63

Mufă cu inel de etanșare Geberit HDPE cu garnitură de etanșare cu manșetă

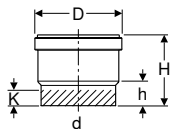

click & scan

Cod art.	DN	d, ø [mm]	D [cm]	H [cm]	h [cm]	K [cm]	EUR/buc.
360.779.16.3	40	40	5,5	8	3,5	2,5	3,02
361.779.16.3	50	50	6,5	8	3,5	2,5	3,02
363.779.16.3	56	56	7	8,3	3,5	2,5	4,68
364.779.16.3	60	63	7,8	8,8	3,5	2,5	5,17
365.779.16.3	70	75	9	9,7	3,5	2,5	5,54
366.779.16.3	90	90	10,6	10,3	3,6	2	6,73
367.779.16.3	100	110	12,9	10,5	3,7	2	7,45
368.779.16.3	125	125	14,7	11	3,8	2	11,76
369.779.16.3	150	160	18,5	13,6	4	2	20,73

Mufă cu inel de etanșare Geberit HDPE redusă, cu garnitură de etanșare cu manșetă

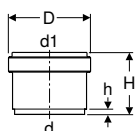

click & scan

Cod art.	DN	d, ø [mm]	d1, ø [mm]	D [cm]	H [cm]	h [cm]	EUR/buc.
361.752.16.3	50	56	50	6,5	5,2	0,7	3,02
364.752.16.3	56	63	56	7,1	5,1	0,7	5,17

Adaptoare la alte materiale

Element de prindere cu reducere Geberit

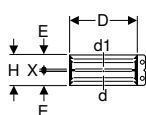

click & scan

Cod art.	DN	d, ø [mm]	d1, ø [mm]	D [cm]	E [cm]	H [cm]	X [cm]	EUR/buc.
359.424.00.2	50	48-50	48-50	6,3	2,7	5,7	0,3	11,52
359.465.00.2	50	50	58	7,5	2,7	5,7	0,3	13,08
359.425.00.2	50	54-56	54-56	7,5	2,7	5,7	0,3	12,95
359.426.00.2	56	56	58	7,5	2,7	5,7	0,3	12,95
359.427.00.2	56	56	68	8,3	2,7	5,7	0,3	12,95
359.428.00.2	60	63	60	7,8	2,7	5,7	0,3	12,95
359.429.00.2	60	63-64	63-64	7,8	2,7	5,7	0,3	12,95
359.430.00.2	60	63-64	68	8,3	2,7	5,7	0,3	12,95
359.431.00.2	70	68	68	8,3	2,6	5,6	0,4	12,95
359.432.00.2	70	75	68	9	2,7	5,7	0,3	16,78
359.433.00.2	70	75-76	75-76	8,8	2,7	5,7	0,3	16,78
359.434.00.2	70	75-76	78	9,3	2,7	5,7	0,3	16,78
359.435.00.2	70	75-76	83-84	9,8	2,7	5,7	0,3	16,78
359.436.00.2	70	75-76	89-90	10,3	2,7	5,7	0,3	16,78
359.437.00.2	90	89-90	83-84	11,1	2,7	5,7	0,3	14,40
359.438.00.2	90	89-90	89-90	10,3	2,7	5,7	0,3	14,40
359.439.00.2	90	89-90	96	11,1	3,3	6,9	0,3	14,40
359.440.00.2	100	108-110	106	12,5	2,7	5,7	0,3	15,59
359.441.00.2	100	108-110	108-110	12,5	2,7	5,7	0,3	15,59
359.442.00.2	100	108-110	114-116	13,1	3,3	6,9	0,3	15,59
359.443.00.2	125	125	125	14	2,7	5,7	0,3	24,81



Cod art.	DN	d, ø [mm]	d1, ø [mm]	D [cm]	E [cm]	H [cm]	X [cm]	EUR/buc.
359.444.00.2	125	125	131-135	15	3,3	6,9	0,3	24,81
359.445.00.2	125	125	140-141	15,6	3,3	6,9	0,3	24,81
359.447.00.2	125	140-141	140-141	15,5	3,3	6,9	0,3	24,81
359.448.00.2	150	159-160	152	17,5	3,3	6,9	0,3	42,28
359.449.00.2	150	159-160	159-160	17,5	3,3	6,9	0,3	42,28
359.450.00.2	150	159-160	168	18,3	3,3	6,9	0,3	42,28
359.451.00.2	200	210	210	22,5	3,3	6,9	0,3	66,60

Inel de susținere Geberit HDPE

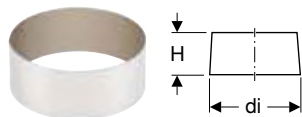

click & scan
EUR/buc.

Cod art.	DN	d, ø [mm]	di, ø [mm]	H [cm]	EUR/buc.
359.454.00.1	50	50	44	4	8,29
359.455.00.1	56	56	50	4	8,64
359.456.00.1	60	63	57	4	8,64
359.457.00.1	70	75	69	4	10,07
359.458.00.1	90	90	83	4	9,35
359.459.00.1	100	110	101,4	4	13,44
359.462.00.1	125	125	115,2	4	15,59
359.463.00.1	125	140	129,2	4	19,07
359.464.00.1	150	160	147,6	4	18,59

Adaptor drept Geberit HDPE pentru plumb



click & scan

Cod art.	DN	d, ø [mm]	d1, ø [mm]	H [cm]	h [cm]	EUR/buc.
359.330.00.1	56	56	54	8,3	3,5	31,64

Adaptor drept Geberit HDPE pentru fontă

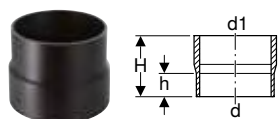

click & scan
EUR/buc.

Cod art.	DN	d, ø [mm]	d1, ø [mm]	H [cm]	h [cm]	EUR/buc.
370.738.16.1	200	200	212	16	8	106,97
371.738.16.1	250	250	274	16	11,5	238,21
372.738.16.1	300	315	326	16	11,5	269,82

Adaptor drept Geberit HDPE pentru PVC

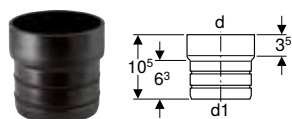

click & scan
EUR/buc.

Cod art.	DN	d, ø [mm]	d1, ø [mm]	EUR/buc.
359.461.16.1	100	110	90	10,69

Adaptor drept Geberit HDPE pentru piatră

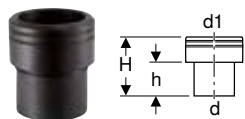

click & scan
EUR/buc.

Cod art.	DN	d, ø [mm]	d1, ø [mm]	H [cm]	h [cm]	EUR/buc.
367.739.16.1	110 / 100	110	132	15,2	7	75,82
368.739.16.1	125	125	159	15,5	7	90,80
369.739.16.1	150 / 150	160	186	15,5	7	120,98
370.739.16.1	200 / 200	200	242	20	13	196,66
371.739.16.1	250 / 250	250	298	20	13	226,95
372.739.16.1	300 / 300	315	352	20	12	272,09

Adaptor drept Geberit HDPE cu mufă cu contracție

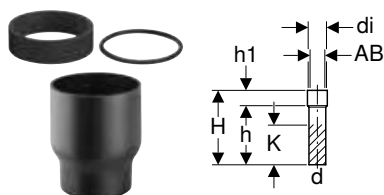

click & scan

Cod art.	DN	d, ø [mm]	AB1 [mm]	AB2 [mm]	di, ø [mm]	H [cm]	h [cm]	h1 [cm]	K [cm]	EUR/buc.
152.197.16.1	50	50	60-67	53-60	70	27,2	22,9	4,3	18	16,31
152.198.16.1	50	50	67-74	60-67	80	28,8	23,6	5,2	18	16,31
152.651.16.1	50	50	53-54	48-49	60	26,7	22,8	3,9	18	16,31
152.652.16.1	50	50	80-84	73-77	90	30,5	24,2	6,3	18	16,31
152.149.16.1	56	56	60-67	53-60	70	23	18,6	4,4	14	18,59
152.150.16.1	56	56	67-74	60-67	80	24,7	19,5	5,2	14	18,59
152.654.16.1	56	56	53-54		60	22,3	18,4	3,9	14	19,30
152.657.16.1	60	63	60-67		73	22,7	18,4	4,3	14	20,02
152.658.16.1	60	63	67-74		80	24,3	19,1	5,2	14	19,90
152.151.16.1	70	75	80-84	73-77	90	24,2	17,6	6,6	13	19,07
152.152.16.1	70	75	67-74		80	22,7	17,5	5,2	13	19,07
152.661.16.1	70	75	90-94		100	24,8	18,1	6,7	13	25,53
366.550.16.1	90	90	84-98		110	17	7,6	9,4	1	24,22
367.550.16.1	100	110	102-126	100-124	140	18	7,5	10,5	1	25,29
367.551.16.1	100	110	102-111	100-109	125	16,2	6,7	9,5	1	25,29
368.550.16.1	125	125	116-136	115-134	150	18	8	10	1	28,28
369.550.16.1	150	160	148-180	149-176	195	20	8,3	11,7	1	44,22
369.551.16.1	150	160	189-212	187-220	230	32,3	16,3	16	3	51,52
370.550.16.1	200	200	189-212	187-220	230	30,2	13,7	16,5	1	110,19
371.550.16.1	250	250	236-260	234-250	280	30,2	13,2	17	1	156,17
372.550.16.1	300	315	297-333	295-323	355	30,2	15,5	14,7	2	214,97



- În funcție de zona de racordare, se montează fie garnitura cu compresiune, fie garnitura inelară rotundă

Îmbinări filetate

Ștuț filetat Geberit HDPE cu îmbinare filetată prin strângere

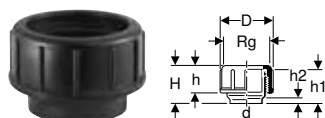

click & scan
EUR/buc.

Cod art.	DN	d, ø [mm]	Rg ["]	GI ["]	D [cm]	H [cm]	h [cm]	h2 [cm]	h1 [cm]	EUR/buc.
379.740.16.1	30	32	1/8"	44	5,6	4,5	2,6	1	3	3,74
360.740.16.1	40	40	1/6"	52	6,4	6,3	3,3	2	5	3,74
361.740.16.1	50	50	1/6"	62	7,4	6,3	3,3	2	5	4,21
363.740.16.1	56	56	1/6"	70	8,5	6,8	3,5	2	5	6,13
364.740.16.1	60	63	1/6"	75	9	6,8	4,2	2	5	7,45



Cod art.	DN	d, ø [mm]	Rg ["]	Gl ["]	D [cm]	H [cm]	h [cm]	h2 [cm]	h1 [cm]	EUR/buc.
365.740.16.1	70	75	1/6"	95	11,2	9,6	4,5	2,5	7,5	9,60
366.740.16.1	90	90	1/4"	110	12,9	9,7	5	2,5	7,5	9,99
367.740.16.1	100	110	1/4"	130	14,9	9,7	6,5	2,5	7,5	11,52

Ștuț filetat Geberit HDPE cu clapetă de închidere

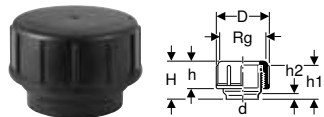

click & scan
EUR/buc.

Cod art.	DN	d, ø [mm]	Rg ["]	Gl ["]	D [cm]	H [cm]	h [cm]	h2 [cm]	h1 [cm]	EUR/buc.
379.750.16.1	30	32	1/8"	44	5,6	4,5	2,6	1	3	3,82
360.750.16.1	40	40	1/6"	52	6,4	6,3	3,3	2	5	3,82
361.750.16.1	50	50	1/6"	62	7,4	6,3	3,3	2	5	4,92
363.750.16.1	56	56	1/6"	70	8,5	6,8	3,5	2	5	5,76
364.750.16.1	60	63	1/6"	75	9	6,8	4,2	2	5	7,45
365.750.16.1	70	75	1/6"	95	11,2	9,6	4,5	2,5	7,5	9,60
366.750.16.1	90	90	1/4"	110	12,9	9,7	4,8	2,5	7,5	11,03
367.750.16.1	100	110	1/4"	130	14,9	9,7	6,3	2,5	7,5	11,76

Șurub de etanșare Geberit HDPE

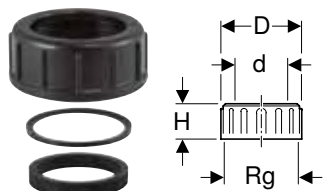

click & scan

Cod art.	DN	d, ø [mm]	Rg ["]	Gl ["]	D [cm]	H [cm]	EUR/buc.
363.749.16.1	56	56	1/6"	70	8,5	6,8	3,26
364.749.16.1	60	63	1/6"	75	9	6,8	4,21

Ștuț filetat Geberit HDPE cu clapetă de închidere



click & scan
EUR/buc.

Cod art.	DN	d, ø [mm]	Rg ["]	Gl ["]	D [cm]	H [cm]	EUR/buc.
367.471.16.1	100	110	1/4"	130	14,3	4	10,69

Adaptor Geberit HDPE cu filet exterior

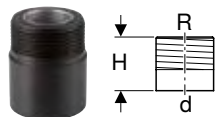

click & scan
EUR/buc.

Cod art.	DN	d, ø [mm]	R ["]	H [cm]	EUR/buc.
361.726.16.1	50	50	1 1/4"	6	15,83
361.727.16.1	50	50	1 1/2"	6	15,83
363.728.16.1	56	56	2"	6,5	18,23
364.728.16.1	60	63	2"	6,5	20,50
365.729.16.1	70	75	2 1/2"	7	27,33

Adaptor Geberit HDPE cu filet interior

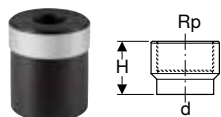

click & scan
EUR/buc.

Cod art.	DN	d, ø [mm]	Rp ["]	H [cm]	EUR/buc.
360.719.16.1	40	40	1/2"	5,5	14,40
360.720.16.1	40	40	3/4"	5,5	14,40
360.721.16.1	40	40	1"	5,5	14,40
361.719.16.1	50	50	1/2"	6	15,83
361.720.16.1	50	50	3/4"	6	15,83
361.721.16.1	50	50	1"	6	15,83
361.722.16.1	50	50	1 1/4"	6	15,83
361.723.16.1	50	50	1 1/2"	6	15,83
363.724.16.1	56	56	2"	6,5	18,23
364.724.16.1	60	63	2"	7	20,50
365.725.16.1	70	75	2 1/2"	7	30,44

Adaptor drept Geberit HDPE cu filet exterior și îmbinare filetată prin strângere

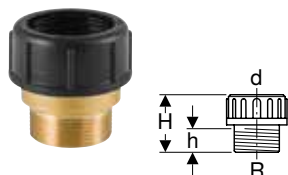

click & scan

Cod art.	DN	d, ø [mm]	R ["]	H [cm]	h [cm]	EUR/buc.
359.309.00.1	50	50	1 1/2"	6,5	2,7	20,50
359.311.00.1	56	56	2"	6,5	2,7	28,28

Adaptor drept Geberit HDPE cu filet interior și îmbinare filetată prin strângere

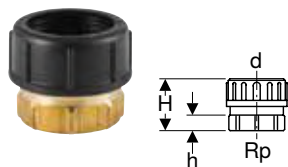

click & scan

Cod art.	DN	d, ø [mm]	Rp ["]	H [cm]	h [cm]	EUR/buc.
359.313.00.1	56	56	2"	6	1,8	28,28

Adaptor drept Geberit HDPE cu îmbinare filetată prin strângere, pentru lipire



click & scan

Cod art.	DN	d, ø [mm]	d1, ø [mm]	H [cm]	h [cm]	EUR/buc.
359.421.00.1	56 / 50	56	50	8	4	18,59
359.423.00.1	56 / 60	56	63	7,8	4	18,59



Conexiuni cu flanșă

Flanșă oarbă Geberit HDPE



click & scan
EUR/buc.

Cod art.	DN	d, ø [mm]	D [cm]	k [mm]	m [mm]	H [cm]	n [pc.]	PN [bar]	
361.748.00.1	50	50	15	110	18	1,2	4	10	23,74
363.748.00.1	56 / 60	56 / 63	16,5	125	18	1,2	4	10	27,33
365.748.00.1	70	75	18,5	145	18	1,2	4	10	27,33
366.748.00.1	90	90	20	160	18	1,4	8	10	28,88
367.748.00.1	100	110	22	180	18	1,4	8	10	32,60
368.748.00.1	125	125	25	210	18	1,4	8	10	52,95
369.748.00.1	150	160	28,5	240	23	1,4	8	10	66,60
370.748.00.1	200	200	34	295	23	1,4	8	3,2	90,67
371.748.00.1	250	250	39,5	350	23	1,6	12	3,2	118,10
372.748.00.1	300	315	44,5	400	23	2	12	3,2	166,12

De comandat suplimentar

- Etanșare de flanșă Geberit HDPE → p. 39

Flanșă liberă Geberit HDPE



click & scan
EUR/buc.

Cod art.	DN	d, ø [mm]	D [cm]	k [mm]	m [mm]	H [cm]	n [pc.]	PN [bar]	
361.745.00.1	50	50	15	110	18	1,2	4	10	14,64
363.745.00.1	56 / 60	56 / 63	16,5	125	18	1,2	4	10	15,59
365.745.00.1	70	75	18,5	145	18	1,2	4	10	18,59
366.745.00.1	90	90	20	160	18	1,4	8	10	20,91
367.745.00.1	100	110	22	180	18	1,4	8	10	23,74
368.745.00.1	125	125	25	210	18	1,4	8	10	24,22
369.745.00.1	150	160	28	240	23	1,4	8	10	39,55
370.745.00.1	200	200	34	295	23	1,4	8	3,2	54,01
371.745.00.1	250	250	39,5	350	23	1,6	12	3,2	72,60
372.745.00.1	300	315	44,5	400	23	2	12	3,2	106,00

De comandat suplimentar

- Etanșare de flanșă Geberit HDPE → p. 39

Element presdat Geberit HDPE

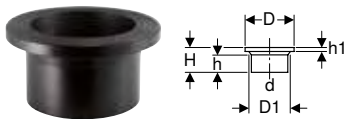

click & scan
EUR/buc.

Cod art.	DN	d, ø [mm]	D [cm]	D1 [cm]	H [cm]	h [cm]	h1 [cm]	
361.744.16.1	50	50	8	5,4	6	4,2	0,8	8,88
363.744.16.1	56	56	9	6,8	6	3,6	0,8	8,88
364.744.16.1	60	63	9	6,8	6	3,7	0,8	11,03
365.744.16.1	70	75	11	7,8	6,5	4	0,9	11,03
366.744.16.1	90	90	12,8	9,6	7	4,4	1,1	13,96
367.744.16.1	100	110	14,8	11,6	7,5	4,8	1,2	15,67
368.744.16.1	125	125	16	13,1	8	5	1,4	19,46
369.744.16.1	150	160	19,8	16,5	9	5,1	1,7	28,85
370.744.16.1	200	200	26	20,6	7,8	5,4	1,4	43,40
371.744.16.1	250	250	32,5	25,6	7,8	5,2	1,6	75,59
372.744.16.1	300	315	37	31,5	10	7	2	182,04

Geberit HDPE

Racorduri de aparate
Bucșe de fixare

Set șuruburi Geberit PE

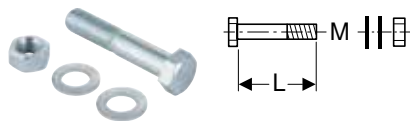

click & scan
EUR/buc.

Cod art.	Culoare/suprafață	d, ø [mm]	M [mm]	L [cm]	
361.743.26.1	Galvanizat	50-75	16	7	3,26
366.743.26.1	Galvanizat	90-125	16	8	3,26
369.743.26.1	Galvanizat	160-200	20	9	5,40
371.743.26.1	Galvanizat	250	20	10	6,49
372.743.26.1	Galvanizat	315	20	11	7,69

Bucșe de fixare

Bucșă fuzetă Geberit HDPE

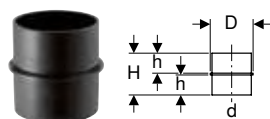

click & scan
EUR/buc.

Cod art.	DN	d, ø [mm]	D [cm]	H [cm]	h [cm]	
379.772.16.1	30	32	3,8	5,2	2,4	3,26
360.772.16.1	40	40	4,7	6,8	3,2	3,26
361.772.16.1	50	50	5,7	6,8	3,2	3,26
363.772.16.1	56	56	6,5	5,8	2,7	3,26
364.772.16.1	60	63	7	7,2	3,4	4,21
365.772.16.1	70	75	9	7,2	3,4	4,21
366.772.16.1	90	90	10,3	9,2	4,4	5,40
367.772.16.1	100	110	12	11,7	5,6	6,49

Racorduri de aparate

Coturi de conectare

Cot de conectare 88,5° Geberit HDPE pentru vas WC pe pardoseală

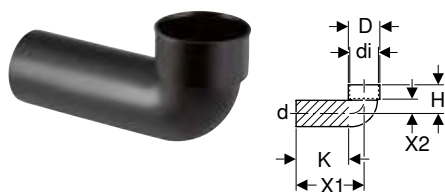

click & scan

Cod art.	DN	d, ø [mm]	arc [°]	di, ø [mm]	D [cm]	H [cm]	X1 [cm]	X2 [cm]	K [cm]	EUR/buc.
367.880.16.1	100	110	88,5	120	13,2	12	30	6	22	14,87

De comandat suplimentar

- Manșetă



Cot de conectare 88,5° Geberit HDPE cu racorduri laterale suplimentare, pentru vas WC pe pardoseală

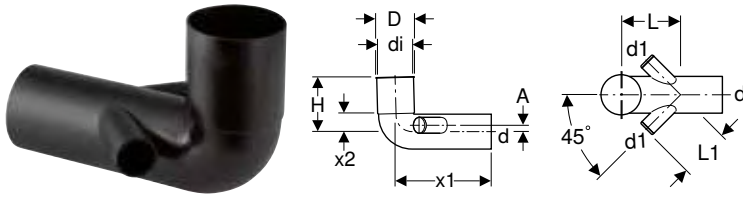

Cod art.	DN	d, ø [mm]	d1, ø [mm]	arc [°]	A [cm]	di, ø [mm]	D [cm]	L [cm]	L1 [cm]	H [cm]	X1 [cm]	X2 [cm]	EUR/buc.
367.888.16.1	100 / 50	110	50	88,5	2	110	11,6	17,5	14	17	30	6	20,98

Cot de conectare 90° Geberit HDPE pentru mufă

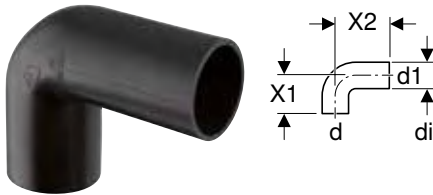

Cod art.	DN	d, ø [mm]	d1, ø [mm]	arc [°]	di, ø [mm]	X1 [cm]	X2 [cm]	EUR/buc.
361.080.16.1	50	50	50	90	44	7,5	10	3,26
363.080.16.1	56	56	56	90	50	7,5	10	3,74
363.083.16.1	56	56	50	90	44	7,5	10	3,74
364.084.16.1	56	56	63	90	57	7,5	20	9,35

De comandat suplimentar

- Manșetă

Cot de conectare 90° Geberit HDPE pentru vas WC suspendat, cu extensie

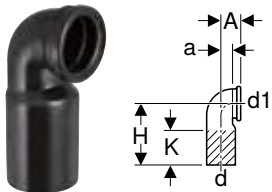

Cod art.	DN	d, ø [mm]	d1, ø [mm]	arc [°]	A [cm]	a [cm]	H [cm]	K [cm]	EUR/buc.
366.925.16.1	90 / 90	90	90	90	7,8	4,5	22,5	13	14,15
367.792.16.1	100 / 100	110	110	90	7,5	4,5	22,5	13	16,78
367.925.16.1	100 / 90	110	90	90	7,5	4,5	22,5	13	16,43

Cot de conectare dublu 90° Geberit HDPE pentru vas WC suspendat

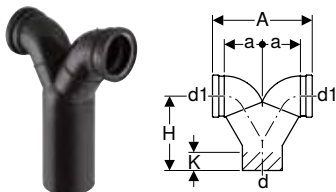

Cod art.	DN	d, ø [mm]	d1, ø [mm]	arc [°]	A [cm]	a [cm]	H [cm]	K [cm]	EUR/buc.
367.903.16.1	100 / 100 / 100	110	110	90	28,5	11	20,5	5	87,07
367.923.16.1	100 / 90 / 90	110	90	90	27,5	10,5	32,5	19	87,07

Cot de conectare dublu 90° Geberit HDPE pentru mufă

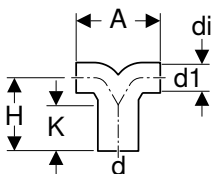

click & scan

Cod art.	DN	d, ø [mm]	d1, ø [mm]	arc [°]	A [cm]	di, ø [mm]	H [cm]	K [cm]	EUR/buc.
363.472.16.1	56 / 50	56	50	90	15,5	44	12	3	23,74
365.472.16.1	70 / 56	75	56	90	15,5	50	13,5	6	36,19

De comandat suplimentar

- Manșetă

Cot de conectare dublu 90° Geberit HDPE, îndoit, pentru vas WC suspendat

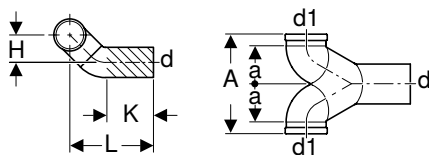

click & scan

Cod art.	DN	d, ø [mm]	d1, ø [mm]	arc [°]	A [cm]	a [cm]	L [cm]	H [cm]	K [cm]	EUR/buc.
367.485.16.1	100 / 90 / 90	110	90	90	27,5	10,5	34	10	12	76,18
367.904.16.1	100 / 100 / 100	110	110	90	28,5	11	34	10	12	76,90

Mufe de conectare

Mufă de conectare cu inel de etanșare Geberit HDPE cu garnitură de etanșare cu manșetă

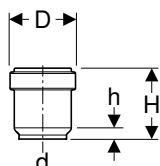

click & scan

Cod art.	DN	d, ø [mm]	D [cm]	H [cm]	h [cm]	EUR/buc.
379.768.16.3	30	32	4,4	4,8	0,8	3,37

Mufă de conectare cu inel de etanșare Geberit HDPE cu garnitură de etanșare, pentru vas WC suspendat

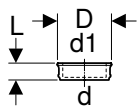

click & scan

Cod art.	DN	d, ø [mm]	d1, ø [mm]	D [cm]	L [cm]	EUR/buc.
366.941.16.1	90 / 90	90	90	11,1	4	6,96
367.941.16.1	100 / 90	110	90	11,1	4	8,04



Ștuțuri de conectare

Ștuț de conectare Geberit HDPE pentru vas WC pe pardoseală

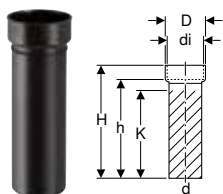

click & scan

Cod art.	DN	d, ø [mm]	di, ø [mm]	D [cm]	H [cm]	h [cm]	K [cm]	EUR/buc.
367.885.16.1	100	110	120	13,2	38	33	26	20,50

De comandat suplimentar

- Manșetă

Ștuț de conectare Geberit HDPE cu mufă cu inel de etanșare, pentru vas WC suspendat

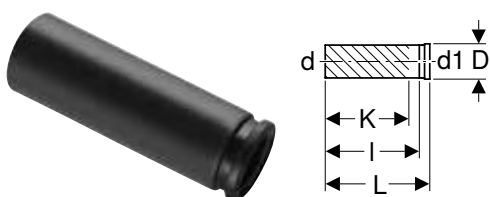

click & scan

Cod art.	DN	d, ø [mm]	d1, ø [mm]	D [cm]	L [cm]	I [cm]	K [cm]	EUR/buc.
366.887.16.1	90 / 90	90	90	11,2	31	27,5	24	16,54
367.887.16.1	100 / 90	110	90	11,2	34,5	31,5	28	18,23

Sifoane tip P

Sifon tip P Geberit HDPE

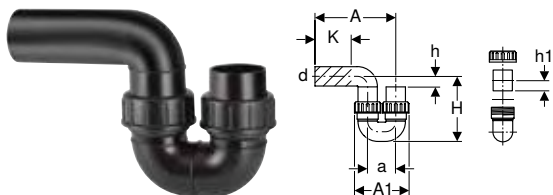

click & scan

Cod art.	DN	d, ø [mm]	Capacitate de evacuare [l/s]	A [cm]	A1 [cm]	a [cm]	H [cm]	h [cm]	h1 [cm]	K [cm]	EUR/buc.
364.730.16.1	60	63	1,4	30,5	18,5	9,5	20,5	5	3,4	16	39,55
365.730.16.1	70	75	2,4	34,5	25	13,5	29,5	7	3,4	14	69,60
366.730.16.1	90	90	3,6	41	27	14	27	5	5,6	20	81,70
367.730.16.1	100	110	5,9	46	31	16	31,5	6	5,6	22	92,84

Sifoane tip melc

Sifon melc Geberit HDPE, cu orificiu de service

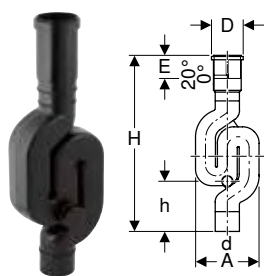

click & scan

Cod art.	DN	d, ø [mm]	Capacitate de evacuare [l/s]	G ["]	A [cm]	D [cm]	E [cm]	H [cm]	h [cm]	EUR/buc.
365.813.16.1	70	75	3,8	2 1/2"	19,8	9,8	8-10,5	66,7	16,6	65,64
367.813.16.1	100	110	9,6	4"	28,8	13,6	8-10,5	80,8	21,7	92,36

Accesorii

Brățări pentru conducte

Brățară pentru țevă Geberit cu piuliță conector G 1/2", reglabilă

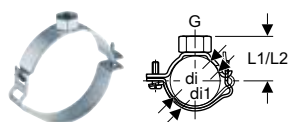

click & scan

Cod art.	Culoare/suprafață	DN	G ["]	di, ø [mm]	di1, ø [mm]	L1 [cm]	L2 [cm]	B [cm]	EUR/buc.
360.841.00.2	Galvanizat	40	1/2"	40	48	3,8	4,2	3	4,31
361.841.00.2	Galvanizat	50	1/2"	50	58	4,3	4,7	3	4,31
363.841.00.2	Galvanizat	56	1/2"	56	64	4,6	5	3	4,68
364.841.00.2	Galvanizat	60	1/2"	63	71	5	5,4	3	4,68
365.841.00.2	Galvanizat	70	1/2"	75	83	5,6	6	3	4,92
366.841.00.2	Galvanizat	90	1/2"	90	98	6,3	6,7	3	4,92
367.841.00.2	Galvanizat	100	1/2"	110	118	7,3	7,7	3	4,92
368.841.00.2	Galvanizat	125	1/2"	125	133	8,1	8,5	3	5,32
369.841.00.2	Galvanizat	150	1/2"	160	168	9,8	10,2	3	5,32

Brățară pentru țevă Geberit cu piuliță conector M10, reglabilă

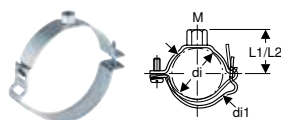

click & scan

Cod art.	Culoare/suprafață	DN	M [mm]	di, ø [mm]	di1, ø [mm]	L1 [cm]	L2 [cm]	B [cm]	EUR/buc.
360.843.00.2	Galvanizat	40	10	40	48	3,5	3,9	3	4,06
361.843.00.2	Galvanizat	50	10	50	58	4	4,4	3	4,06
363.843.00.2	Galvanizat	56	10	56	64	4,3	4,7	3	4,31
364.843.00.2	Galvanizat	60	10	63	71	4,7	5,1	3	4,31
365.843.00.2	Galvanizat	70	10	75	83	5,3	5,7	3	4,68
366.843.00.2	Galvanizat	90	10	90	98	6	6,4	3	4,68
367.843.00.2	Galvanizat	100	10	110	118	7	7,4	3	4,68
368.843.00.2	Galvanizat	125	10	125	133	7,8	8,2	3	5,07
369.843.00.2	Galvanizat	150	10	160	168	9,5	9,9	3	5,69



- Neadekvat pentru utilizare ca punct fix



Colier țevă Geberit cu piuliță conector G 3/4", reglabil

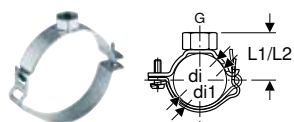

click & scan
EUR/buc.

Cod art.	Culoare/suprafață	DN	G ["]	di, ø [mm]	di1, ø [mm]	L1 [cm]	L2 [cm]	B [cm]	
360.842.00.1	Galvanizat	40	3/4"	40	48	4	4,4	3	6,33
361.842.00.1	Galvanizat	50	3/4"	50	58	4,5	4,9	3	7,02
363.842.00.1	Galvanizat	56	3/4"	56	64	4,8	5,2	3	7,60
364.842.00.1	Galvanizat	60	3/4"	63	71	5,2	5,6	3	7,60
365.842.00.1	Galvanizat	70	3/4"	75	83	5,8	6,2	3	7,60
366.842.00.1	Galvanizat	90	3/4"	90	98	6,5	6,9	3	7,97
367.842.00.1	Galvanizat	100	3/4"	110	118	7,5	7,9	3	7,97
368.842.00.1	Galvanizat	125	3/4"	125	133	8,3	8,7	3	8,09
369.842.00.1	Galvanizat	150	3/4"	160	168	10	10,4	3	8,98

Brățară pentru țevă Geberit cu piuliță conector G 1"

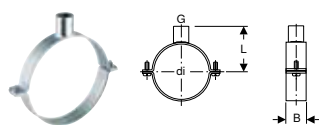

click & scan
EUR/buc.

Cod art.	Culoare/suprafață	DN	G ["]	di, ø [mm]	L [cm]	B [cm]	
370.840.00.1	Galvanizat	200	1"	200	14,8	4	15,15
371.840.00.1	Galvanizat	250	1"	250	17,3	4	18,17
372.840.00.1	Galvanizat	300	1"	315	20,5	4	20,32

Colier țevă Geberit cu piuliță conector G 1 1/4"

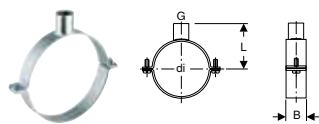

click & scan
EUR/buc.

Cod art.	Culoare/suprafață	DN	G ["]	di, ø [mm]	L [cm]	B [cm]	
370.841.00.1	Galvanizat	200	1 1/4"	200	15,8	4	17,34
371.841.00.1	Galvanizat	250	1 1/4"	250	17,3	4	20,58
372.841.00.1	Galvanizat	300	1 1/4"	315	20,5	4	25,14

Brățară pentru țevă Geberit cu piuliță conector M8 / M10

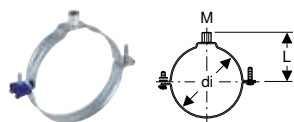

click & scan
EUR/buc.

Cod art.	Culoare/suprafață	M [mm]	di, ø [mm]	L [cm]	
360.832.00.2	Galvanizat	8 / 10	40	4,3	3,29
361.832.00.2	Galvanizat	8 / 10	50	4,8	3,29
363.832.00.2	Galvanizat	8 / 10	56	5,1	3,54
364.832.00.2	Galvanizat	8 / 10	63	5,5	3,54
365.832.00.2	Galvanizat	8 / 10	75	6,1	3,81
366.832.00.2	Galvanizat	8 / 10	90	6,8	3,81
367.832.00.2	Galvanizat	8 / 10	110	7,8	3,81
368.832.00.2	Galvanizat	8 / 10	125	8,6	4,31
369.832.00.2	Galvanizat	8 / 10	160	10,3	4,92

Dispozitive de fixare pentru brățări pentru conducte

Bucșă fuzetă dublă Geberit HDPE

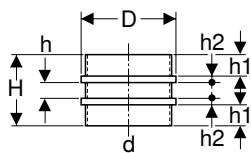

click & scan

Cod art.	DN	d, ø [mm]	D [cm]	H [cm]	h [cm]	h2 [cm]	h1 [cm]	EUR/buc.
370.751.16.1	200	200	21,3	19,1	4,1	1,5	6	46,96
371.751.16.1	250	250	26,2	20,1	4,1	2	6	66,12
372.751.16.1	300	315	32,6	20,1	4,1	2	6	91,16

Bandă de electrofuziune Geberit pentru punct fix

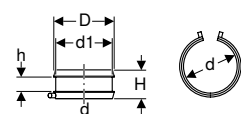

click & scan

Cod art.	DN	d, ø [mm]	d1, ø [mm]	D [cm]	H [cm]	h [cm]	EUR/buc.
361.776.16.1	50	50	58	6,6	6	3	10,56
363.776.16.1	56	56	64	7,2	6	3	11,52
364.776.16.1	60	63	71	7,9	6	3	11,52
365.776.16.1	70	75	83	9,1	6	3	12,59
366.776.16.1	90	90	98	10,6	6	3	14,40
367.776.16.1	100	110	118	12,6	6	3	15,83
368.776.16.1	125	125	133	14,1	6	3	17,87
369.776.16.1	150	160	168	17,6	6	3	20,98
370.776.16.1	200	200	208	21,6	6	3	25,29
371.776.16.1	250	250	258	26,6	6	3	31,64

Set bandă de electrofuziune pentru punct fix Geberit

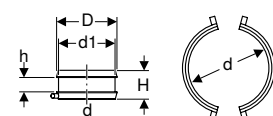

click & scan

Cod art.	DN	d, ø [mm]	d1, ø [mm]	D [cm]	H [cm]	h [cm]	EUR/buc.
372.776.16.1	300	315	323	33,1	6	3	47,20

Placă de fixare Geberit dreptunghiulară, două orificii, cu piuliță conector M10/G 1/2"

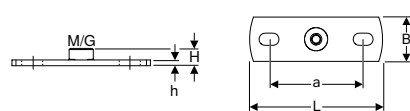

click & scan

Cod art.	G ["]	M [mm]	a [cm]	L [cm]	B [cm]	H [cm]	h [cm]	EUR/buc.
362.851.26.1	1/2"	10	8,5	12	4	1,5	0,5	4,68



Placă de fixare Geberit dreptunghiulară, două orificii, cu piuliță conector M8/M10

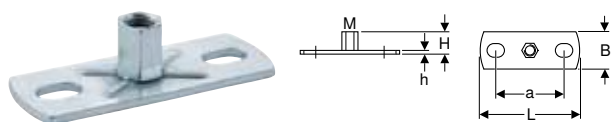

click & scan
EUR/buc.

Cod art.	M [mm]	a [cm]	L [cm]	B [cm]	H [cm]	h [cm]	
362.848.26.1	8 / 10	5,4	8	3	1,9	0,3	3,81

Placă de fixare Geberit dreptunghiulară, două orificii, cu piuliță conector G

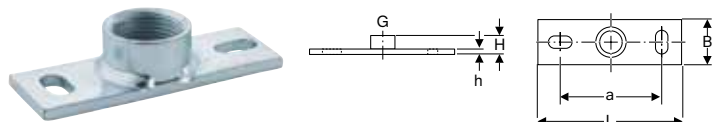

click & scan
EUR/buc.

Cod art.	G ["]	a [cm]	L [cm]	B [cm]	H [cm]	h [cm]	
362.826.26.1	1/2"	9	12	4	2,1	0,6	4,68
362.827.26.1	3/4"	9	12	4	2,3	0,6	5,33
362.828.26.1	1"	9	12	4	2,6	0,6	5,93
362.868.26.1	1 1/4"	11	16	6,5	3	0,8	18,29
362.869.26.1	1 1/2"	11	16	6,5	3	0,8	19,80

Placă de fixare Geberit dreptunghiulară, cu patru găuri, cu piuliță conector G

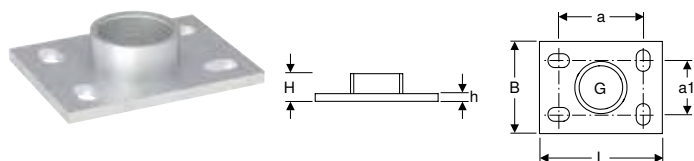

click & scan

Cod art.	Culoare/suprafață	G ["]	a [cm]	a1 [cm]	L [cm]	B [cm]	H [cm]	h [cm]	
362.874.26.1	Galvanizat	2"	11	7	16	12	3,6	1	33,01

Placă de fixare Geberit rotundă, cu trei găuri, cu piuliță conector M10

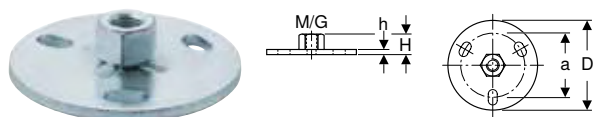

click & scan
EUR/buc.

Cod art.	M [mm]	a [cm]	D [cm]	H [cm]	h [cm]	
362.837.26.1	10	5	7	1,6	0,4	5,69

Placă de fixare Geberit rotundă, cu trei găuri, cu piuliță conector G 1/2"

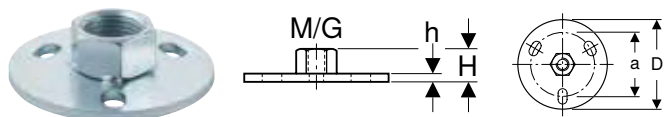

click & scan
EUR/buc.

Cod art.	G ["]	a [cm]	D [cm]	H [cm]	h [cm]	
362.839.26.1	1/2"	5	7	1,9	0,4	5,69

Tijă filetată Geberit



click & scan
EUR/buc.

Cod art.	M [mm]	L [cm]	EUR/buc.
362.836.00.1	10	50	3,17

Tijă filetată Geberit

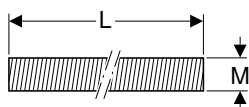

click & scan
EUR/buc.

Cod art.	Culoare/suprafață	M [mm]	L [cm]	EUR/buc.
362.834.26.1	Galvanizat	10	200	6,83

Țeavă filetată Geberit

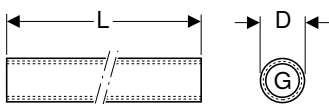
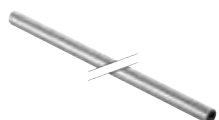

click & scan
EUR/buc.

Cod art.	G ["]	D [cm]	L [cm]	EUR/buc.
362.857.26.1	1/2"	2,5	115	38,24

Țeavă filetată Geberit

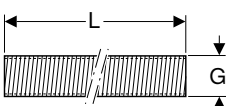
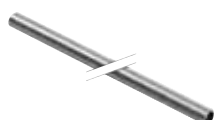

click & scan
EUR/buc.

Cod art.	Culoare/suprafață	G ["]	L [cm]	EUR/buc.
362.852.26.1	Galvanizat	1/2"	200	42,26
362.853.26.1	Galvanizat	3/4"	200	78,94
362.854.26.1	Galvanizat	1"	200	208,43
362.855.26.1	Galvanizat	1 1/4"	200	235,52
362.858.26.1	Galvanizat	1 1/2"	200	335,71
362.859.26.1	Galvanizat	2"	200	447,59

Mufă filetată Geberit



click & scan

Cod art.	Culoare/suprafață	G ["]	M [mm]	L [cm]	EUR/buc.
362.843.26.1	Galvanizat		10	3	2,28
362.844.26.1	Galvanizat	1/2"		3,4	4,81



Adaptor Geberit

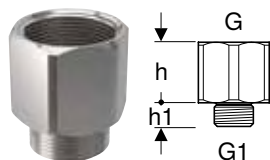

click & scan

Cod art.	Culoare/suprafață	G ["]	G1 ["]	H [cm]	h [cm]	h1 [cm]	EUR/buc.
362.875.26.1	Galvanizat	1"	3/4"	5,2	3,6	1,6	22,87
362.876.26.1	Galvanizat	1 1/4"	3/4"	5,7	4,1	1,6	23,88
362.877.26.1	Galvanizat	1 1/2"	3/4"	7,6	5,6	2	28,59
362.878.26.1	Galvanizat	2"	3/4"	7,2	5,6	1,6	29,85
362.879.26.1	Galvanizat	1 1/2"	1 1/4"	6,6	4,6	2	34,31
362.880.26.1	Galvanizat	2"	1 1/4"	7,6	5,6	2	35,80

Șurub cu filet dublu Geberit



click & scan

Cod art.	L [cm]	EUR/buc.
362.833.00.1	10	1,53

Niplu dublu Geberit M10 / G 1/2"

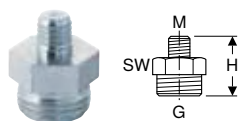

click & scan

Cod art.	Culoare/suprafață	G ["]	M [mm]	H [cm]	SW [mm]	EUR/buc.
362.856.26.1	Galvanizat	1/2"	10	2,8	22	5,60

Înveliș portant

Cochilie suport Geberit, galvanizată și vopsită

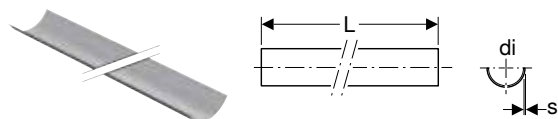

click & scan

Cod art.	Culoare/suprafață	DN	di, ø [mm]	s [mm]	L [m]	EUR/m
360.850.00.1	Vopsit	40	40	0,75	3	4,68
361.850.00.1	Vopsit	50	50	0,75	3	4,68
363.850.00.1	Vopsit	56	56	0,75	3	5,32
364.850.00.1	Vopsit	60	63	0,75	3	5,32
365.850.00.1	Vopsit	70	75	0,75	3	5,69
366.850.00.1	Vopsit	90	90	0,75	3	5,32
367.850.00.1	Vopsit	100	110	0,75	3	7,60
368.850.00.1	Vopsit	125	125	0,75	3	7,84
369.850.00.1	Vopsit	150	160	0,75	3	9,60
370.850.00.1	Vopsit	200	200	0,75	3	12,38
371.850.00.1	Vopsit	250	250	0,75	3	15,66
372.850.00.1	Vopsit	300	315	0,75	3	18,68

Dispozitive de închidere

Capac terminal Geberit HDPE



click & scan
EUR/buc.

Cod art.	DN	d, ø [mm]	EUR/buc.
379.812.16.1	30	32	0,73
360.812.16.1	40	40	0,98
361.812.16.1	50	50	0,98
363.812.16.1	56	56	1,45
364.812.16.1	60	63	1,45
365.812.16.1	70	75	1,70
366.812.16.1	90	90	1,94
367.812.16.1	100	110	2,17
368.812.16.1	125	125	3,26
369.812.16.1	150	160	5,40
370.812.16.1	200	200	7,45

Capac de protecție Geberit HDPE pentru capăt de țevă

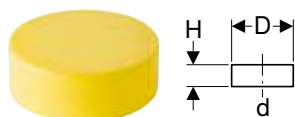

click & scan
EUR/buc.

Cod art.	Culoare/suprafață	DN	d, ø [mm]	D [cm]	H [cm]	EUR/buc.
360.802.92.1	Galben	40	40	4,2	3,5	1,45
361.802.92.1	Galben	50	50	5,2	3,5	1,45
363.802.92.1	Galben	56	56	5,8	3,5	1,45
364.802.92.1	Galben	60	63	6,5	3,5	1,45
365.802.92.1	Galben	70	75	7,8	3,5	1,45
366.802.92.1	Galben	90	90	9,3	3,5	1,45
367.802.92.1	Galben	100	110	11,3	4	1,45
368.802.92.1	Galben	125	125	12,9	4	1,70
369.802.92.1	Galben	150	160	16,4	3	2,53

Capac de închidere Geberit HDPE

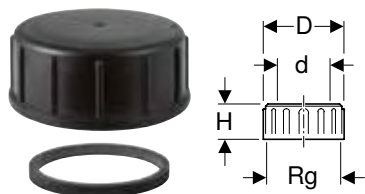

click & scan

Cod art.	DN	d, ø [mm]	Rg ["]	Gl ["]	D [cm]	H [cm]	EUR/buc.
379.781.16.1	30	32	1/8"	44	5,6	2,6	2,17
360.781.16.1	40	40	1/6"	52	6,4	3,3	2,17
362.781.16.1	50	48	1/8"	60	7,5	3,2	3,36
361.781.16.1	50	50	1/6"	62	7,4	3,3	2,17
363.781.16.1	56	56	1/6"	70	8,5	3,5	3,74
364.781.16.1	60	63	1/6"	75	9	4,2	3,74
365.781.16.1	70	75	1/6"	95	11,2	4,5	7,45
366.781.16.1	90	90	1/4"	110	12,9	5	7,45
367.781.16.1	100	110	1/4"	130	14,9	6,5	9,60



Rondelă de reparații Geberit



click & scan
EUR/buc.

Cod art.	d, ø [mm]	
853.650.16.1	40-160	3,09

Etanșări

Mufă Geberit

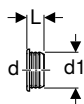

click & scan
EUR/buc.

Cod art.	d, ø [mm]	d1, ø [mm]	L [cm]	
152.498.00.1	32	40	2,5	2,17
152.796.00.1	40	44	2,3	2,18
152.495.00.1	32	46	2,3	2,17
152.496.00.1	40	46	2,3	1,95
153.564.16.1	32	58	2,3	3,68
153.565.16.1	40	58	2,3	3,43
153.566.16.1	50	58	2,3	3,43

Mufă Geberit

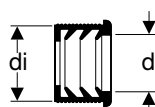

click & scan
EUR/buc.

Cod art.	DN	d, ø [mm]	di, ø [mm]	
152.682.00.1	50	32	44	2,18
152.689.00.1	56	32	50	3,43
152.690.00.1	56	40	50	3,08
152.691.00.1	60	32	57	5,56
152.692.00.1	60	40	57	4,81
152.693.00.1	60	50	57	4,32

Etanșare de flanșă Geberit HDPE

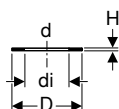

click & scan
EUR/buc.

Cod art.	DN	d, ø [mm]	di, ø [mm]	D [cm]	H [cm]	
361.742.00.1	50	50	45	9,2	0,3	3,26
363.742.00.1	56-60	56-63	59	10,7	0,3	3,74
365.742.00.1	70	75	69	12,7	0,3	4,21
366.742.00.1	90	90	83	14,2	0,3	4,82
367.742.00.1	100	110	102	16,2	0,3	5,40
368.742.00.1	125	125	116	19,2	0,3	6,13
369.742.00.1	150	160	149	21,7	0,3	7,21
370.742.00.1	200	200	191	27,2	0,3	10,79
371.742.00.1	250	250	238	32,7	0,4	20,02
372.742.00.1	300	315	298	37,7	0,4	24,22

Garnitură de etanșare cu manșetă Geberit EPDM



click & scan
EUR/buc.

Cod art.	DN	d, ø [mm]	
242.278.00.1	30	32	1,29
241.785.00.1	40	40	1,29
241.786.00.1	50	50	1,29
244.126.00.1	56	56	1,29
244.127.00.1	60	63	1,84
241.787.00.1	70	75	1,84
241.790.00.1	90	90	1,84
241.791.00.1	100	110	1,84
242.279.00.1	125	125	1,84
242.280.00.1	150	160	1,84

Casete de protecție

Capac de protecție Geberit

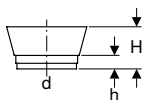

click & scan
EUR/buc.

Cod art.	Culoare/suprafață	DN	d, ø [mm]	H [cm]	h [cm]	
366.820.92.1	Galben	90	90	8,3	3,3	2,70

Capac de protecție Geberit

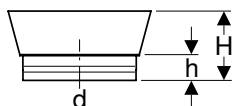

click & scan
EUR/buc.

Cod art.	Culoare/suprafață	DN	d, ø [mm]	H [cm]	h [cm]	
367.819.92.1	Galben	100	110	7,5	2,5	2,78

Materiale consumabile

Lubrifiant Geberit, 250 ml



click & scan
EUR/buc.

Cod art.						
953.761.00.1						4,92

Creion de gresare Geberit cu mină retractabilă



click & scan
EUR/buc.

Cod art.	Culoare/suprafață					
690.102.00.1	Galben					6,97



Protector de cofraj Geberit

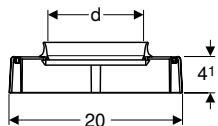

click & scan

Cod art.	DN	d, \varnothing [mm]	L [cm]	B [cm]	H [cm]	EUR/buc.
307.915.00.2	70	75	20	20	4,1	18,61
308.915.00.2	90	90	20	20	4,1	18,61
310.915.00.2	100	110	20	20	4,1	12,41



Sistem convențional de drenaj al acoperișului



Receptori de terasă	44
Elemente barieră de vapori	44
Accesorii.....	45

Receptori de terasă

Receptor de terasă Geberit cu folie de contact

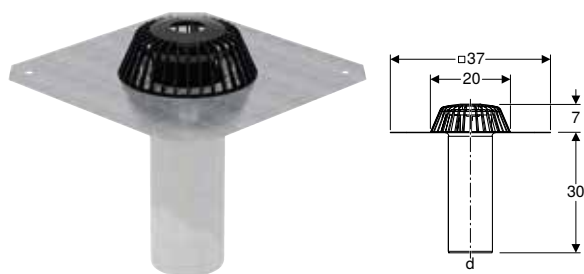

click & scan

Cod art.	DN	d, \emptyset [mm]	Capacitate de evacuare [l/s]	EUR/buc.
359.038.00.1	90	90	5,5	106,17

Accesorii

- Set de completare Geberit, pentru terase circulabile → p. 45

Receptor de terasă Geberit cu folie de contact

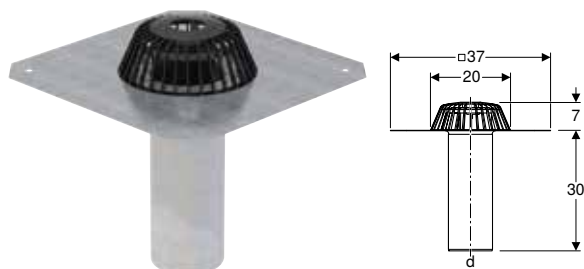

click & scan

Cod art.	DN	d, \emptyset [mm]	Capacitate de evacuare [l/s]	EUR/buc.
359.037.00.1	100	110	6	106,17

Accesorii

- Set de completare Geberit, pentru terase circulabile → p. 45

Receptor de terasă Geberit cu flanșă de fixare, pentru folii de hidroizolație

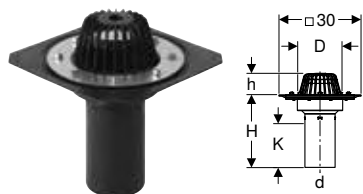

click & scan

Cod art.	DN	d, \emptyset [mm]	D [cm]	H [cm]	h [cm]	K [cm]	EUR/buc.
359.013.00.1	100	110	16	26,5	8	14	130,82

Elemente barieră de vapori

Conexiune cu bariera de vapori Geberit

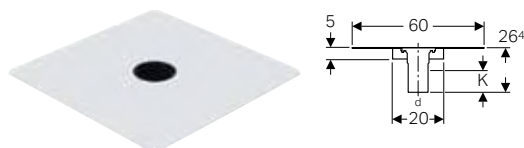

click & scan

Cod art.	d, \emptyset [mm]	K [cm]	EUR/buc.
359.147.00.1	110	14	224,87

Conexiune cu bariera de vapori Geberit Pluvia

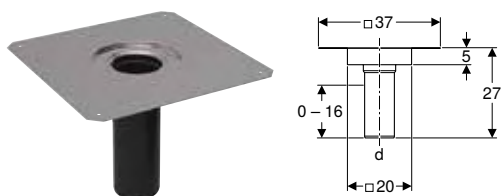

click & scan

Cod art.	DN	Racord etanșare	d, \varnothing [mm]	EUR/buc.
359.102.00.1	90	Oțel CrNi 1.4301	90	163,84

Accesorii

- Placă de instalare Geberit Pluvia → p. 60

Accesorii

Garnitură racord plafon Geberit verticală, cu izolație anticondens și pâlnie de admisie

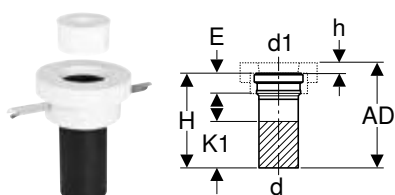

click & scan

Cod art.	d, \varnothing [mm]	d1, \varnothing [mm]	AD [cm]	E [cm]	H [cm]	h [cm]	K1 max. [cm]	EUR/buc.
308.969.00.1	90	90	28,5	3,8	26,5	2	11	113,67
310.969.00.1	110	110	28,5	5	26,5	2	11	120,26

Set de completare Geberit, pentru terase circulabile

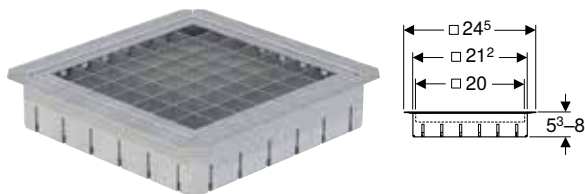

click & scan

Cod art.	EUR/buc.
359.039.00.1	140,20

Placă de instalare Geberit

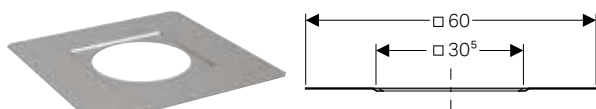

click & scan

Cod art.	EUR/buc.
359.133.00.1	44,79

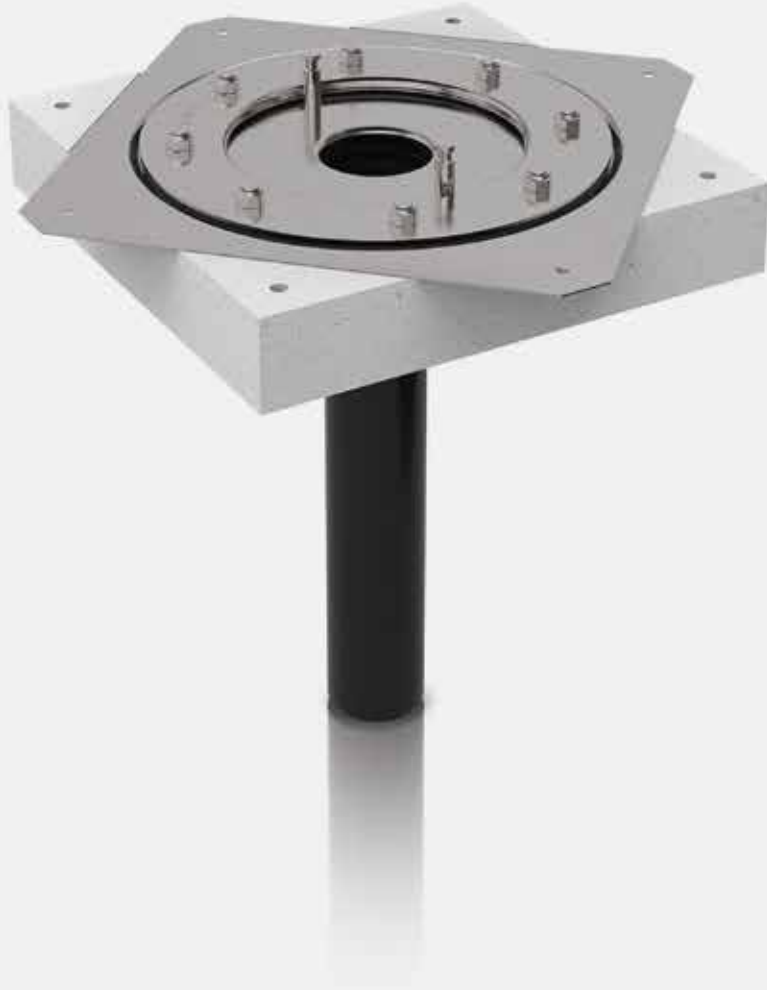
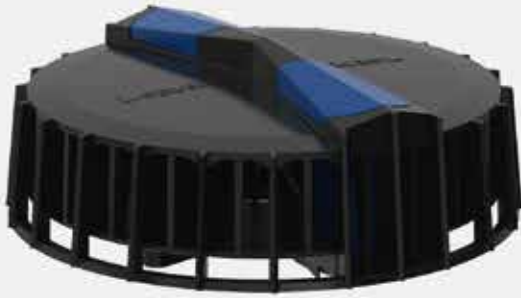

Instalație pluvială Geberit Pluvia



Vedere de ansamblu asupra sortimentului – Drenarea acoperișurilor Geberit Pluvia	48
Receptori de terasă	49
Receptori de terasă cu capacitate de până la 12 l/s	49
Receptori de terasă cu capacitate de până la 25 l/s	51
Receptori de terasă cu capacitate de până la 100 l/s	52
Receptori de terasă pentru jgheaburi.....	53
Receptori de terasă cu capacitate de până la 12 l/s	53
Receptori de terasă cu capacitate de până la 25 l/s	53
Receptori de terasă cu capacitate de până la 100 l/s	54
Elemente barieră de vapori.....	55
Pentru receptori de terasă cu capacitate de până la 12 l/s	55
Pentru receptori de terasă cu capacitate de până la 25 l/s	55
Preaplinuri de urgență.....	56
Pentru receptori de terasă cu capacitate de până la 12 l/s	56
Pentru receptori de terasă cu capacitate de până la 25 l/s	56
Dispozitive de fixare.....	56
Sistem de fixare d40–200	56
Sistem de fixare d250–315	58
Accesorii.....	60
Pentru receptori de terasă.....	60
Pentru dispozitive de fixare.....	62

Vedere de ansamblu asupra sortimentului – Drenarea acoperișurilor Geberit Pluvia

Geberit România, Versiune: December 2023

Montare	Nivel de curgere a apei	Tip de racord		Capacitate maximă de evacuare							
				9 l/s	12 l/s	19 l/s	25 l/s	45 l/s	60 l/s	100 l/s	
Acoperiș plan	Bitum	Folie de contact	359.108.00.1 Receptor de terasă Geberit Pluvia cu folie de contact		✓						
Acoperiș plan			359.127.00.1 Receptor de terasă Geberit Pluvia cu folie de contact, parafrunzar din aluminiu turnat		✓						
Acoperiș plan			359.099.00.1 Receptor de terasă Geberit Pluvia cu folie de contact					✓			
Acoperiș plan			359.345.00.1 Receptor de terasă Geberit Pluvia cu folie de contact						✓		
Acoperiș plan			359.346.00.1 Receptor de terasă Geberit Pluvia cu folie de contact							✓	
Acoperiș plan			359.347.00.1 Receptor de terasă Geberit Pluvia cu folie de contact								✓
Acoperiș plan	Folie de hidroizolație	Flanșă	359.117.00.1 Receptor de terasă Geberit Pluvia cu flanșă de fixare, pentru folii de hidroizolație	✓							
Acoperiș plan			359.105.00.1 Receptor de terasă Geberit Pluvia cu flanșă de fixare, pentru folii de hidroizolație		✓						
Acoperiș plan			359.106.00.1 Receptor de terasă Geberit Pluvia cu flanșă de fixare, parafrunzar din aluminiu turnat			✓					
Acoperiș plan			359.098.00.1 Receptor de terasă Geberit Pluvia cu flanșă de fixare, pentru folii de hidroizolație					✓			
Acoperiș plan	Folie de hidroizolație sau bitum	Folie de contact	359.118.00.1 Receptor de terasă Geberit Pluvia	✓							
Jgheab	359.111.00.1 Receptor de terasă Geberit Pluvia cu folie de contact pentru jgheaburi				✓						
Jgheab	359.100.00.1 Receptor de terasă Geberit Pluvia cu folie de contact pentru jgheaburi						✓				

Montare	Nivel de curgere a apei	Tip de racord		Capacitate maximă de evacuare							
				9 l/s	12 l/s	19 l/s	25 l/s	45 l/s	60 l/s	100 l/s	
Jgheab		Margine de îmbinare	359.034.00.1 Receptor de terasă Geberit Pluvia pentru jgheaburi			✓					
Jgheab			359.342.00.1 Receptor de terasă Geberit Pluvia pentru jgheaburi					✓			
Jgheab			359.343.00.1 Receptor de terasă Geberit Pluvia pentru jgheaburi						✓		
Jgheab			359.344.00.1 Receptor de terasă Geberit Pluvia pentru jgheaburi							✓	
Jgheab		Flanșă	359.112.00.1 Receptor de terasă Geberit Pluvia cu flanșă, pentru jgheaburi		✓						
Jgheab			359.007.00.1 Receptor de terasă Geberit Pluvia cu flanșă, pentru jgheaburi				✓				

✓ Compatibil

Receptori de terasă

Receptori de terasă cu capacitate de până la 12 l/s

Receptor de terasă Geberit Pluvia cu flanșă de fixare, pentru folii de hidroizolație

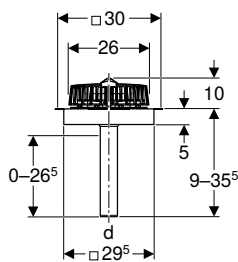

click & scan

Cod art.	DN	Racord etanșare	d, Ø [mm]	EUR/buc.
359.105.00.1	56	Oțel CrNi 1.4301	56	165,70

Accesorii

- Placă de instalare pentru receptor de terasă Geberit Pluvia cu flanșă de conectare, pentru folii de hidroizolație → p. 60

Instalație pluvială Geberit Pluvia

Receptori de terasă

Receptori de terasă cu capacitate de până la 12 l/s

Receptor de terasă Geberit Pluvia cu flanșă de fixare, pentru folii de hidroizolație, parafrunzar din aluminiu turnat

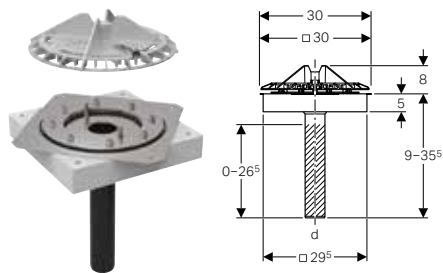

click & scan

Cod art.	DN	Racord etanșare	d, \emptyset [mm]	EUR/buc.
359.106.00.1	56	Oțel CrNi 1.4301	56	218,02

Accesorii

- Placă de instalare pentru receptor de terasă Geberit Pluvia cu flanșă de conectare, pentru folii de hidroizolație → p. 60

Receptor de terasă Geberit Pluvia cu flanșă de fixare, pentru folii de hidroizolație

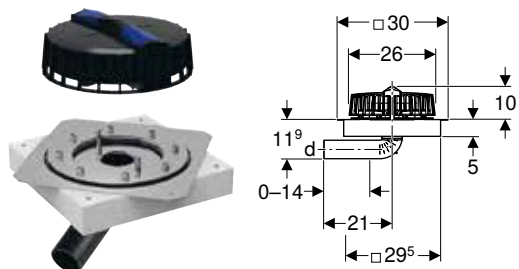

click & scan

Cod art.	DN	Racord etanșare	d, \emptyset [mm]	EUR/buc.
359.117.00.1	56	Oțel CrNi 1.4301	56	185,23

Receptor de terasă Geberit Pluvia

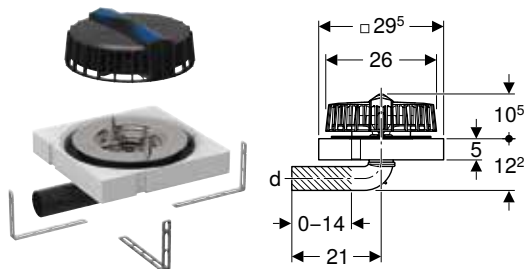

click & scan

Cod art.	DN	d, \emptyset [mm]	EUR/buc.
359.118.00.1	56	56	84,66

Accesorii

- Folie de contact universală Geberit Pluvia → p. 60
- Corp foliat Geberit Pluvia pentru bitum → p. 60

Receptor de terasă Geberit Pluvia cu folie de contact

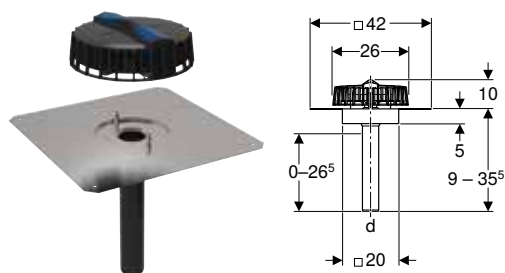

click & scan



Cod art.	DN	Racord etanșare	d, ø [mm]	EUR/buc.
359.108.00.1	56	Oțel CrNi 1.4301	56	127,21

Receptor de terasă Geberit Pluvia cu folie de contact, parafrunzar din aluminiu turnat

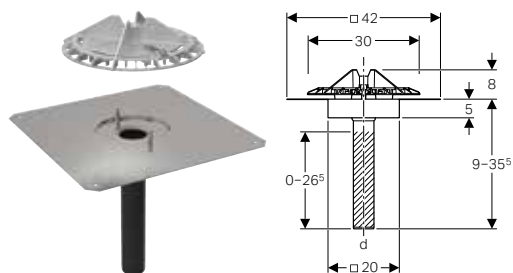

click & scan

Cod art.	DN	Racord etanșare	d, ø [mm]	EUR/buc.
359.127.00.1	56	Oțel CrNi 1.4301	56	186,75

Receptori de terasă cu capacitate de până la 25 l/s

Receptor de terasă Geberit Pluvia cu flanșă de fixare, pentru folii de hidroizolație

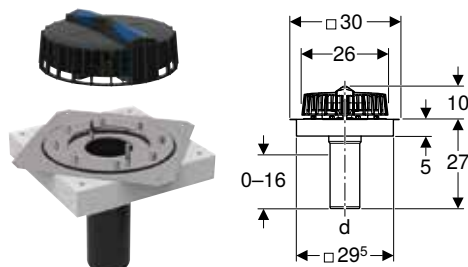

click & scan

Cod art.	DN	Racord etanșare	d, ø [mm]	EUR/buc.
359.098.00.1	90	Oțel CrNi 1.4301	90	278,60

Accesorii

- Placă de instalare pentru receptor de terasă Geberit Pluvia cu flanșă de conectare, pentru folii de hidroizolație → p. 60

Instalație pluvială Geberit Pluvia

Receptori de terasă

Receptori de terasă cu capacitate de până la 100 l/s

Receptor de terasă Geberit Pluvia cu folie de contact

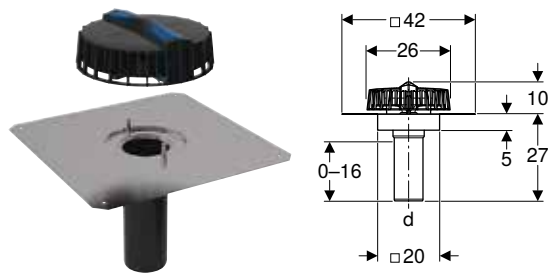

click & scan

Cod art.	DN	Racord etanșare	d, \emptyset [mm]	EUR/buc.
359.099.00.1	90	Oțel CrNi 1.4301	90	233,60

Receptori de terasă cu capacitate de până la 100 l/s

Receptor de terasă Geberit Pluvia cu folie de contact

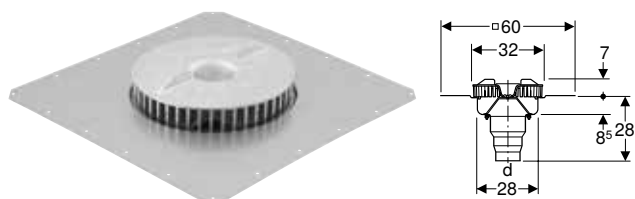

click & scan

Cod art.	DN	Racord etanșare	d, \emptyset [mm]	Capacitate de evacuare [l/s]	EUR/buc.
359.345.00.1	100	Oțel CrNi 1.4301	110	45	492,63

Receptor de terasă Geberit Pluvia cu folie de contact

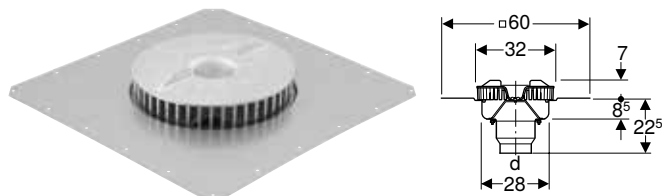

click & scan

Cod art.	DN	Racord etanșare	d, \emptyset [mm]	Capacitate de evacuare [l/s]	EUR/buc.
359.346.00.1	125	Oțel CrNi 1.4301	125	60	492,63

Receptor de terasă Geberit Pluvia cu folie de contact

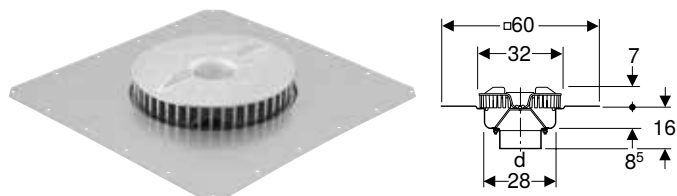

click & scan

Cod art.	DN	Racord etanșare	d, \emptyset [mm]	Capacitate de evacuare [l/s]	EUR/buc.
359.347.00.1	155	Oțel CrNi 1.4301	160	100	492,63

Receptori de terasă pentru jgheaburi

Receptori de terasă cu capacitate de până la 12 l/s

Receptor de terasă Geberit Pluvia cu folie de contact pentru jgheaburi

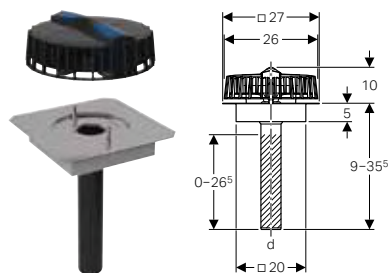

click & scan

Cod art.	DN	Racord etanșare	d, \emptyset [mm]	EUR/buc.
359.111.00.1	56	Oțel CrNi 1.4301	56	136,98

Receptor de terasă Geberit Pluvia cu flanșă, pentru jgheaburi

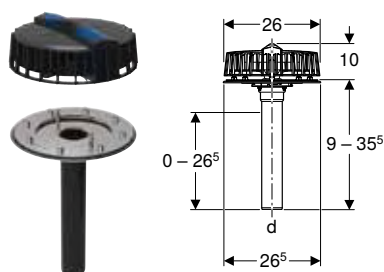

click & scan

Cod art.	DN	Racord etanșare	d, \emptyset [mm]	EUR/buc.
359.112.00.1	56	Oțel CrNi 1.4301	56	199,52

Receptori de terasă cu capacitate de până la 25 l/s

Receptor de terasă Geberit Pluvia pentru jgheaburi

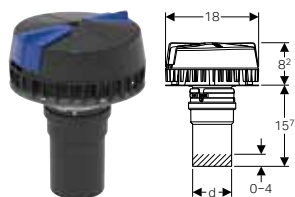

click & scan

Cod art.	DN	d, \emptyset [mm]	EUR/buc.
359.034.00.1	70	75	176,39

Instalație pluvială Geberit Pluvia

Receptori de terasă pentru jgheaburi
Receptori de terasă cu capacitate de până la 100 l/s

Receptor de terasă Geberit Pluvia cu folie de contact pentru jgheaburi

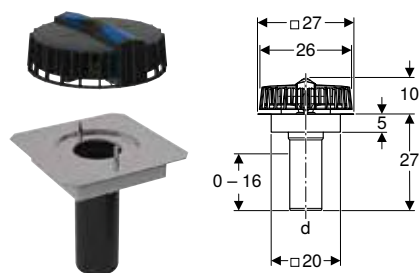

click & scan

Cod art.	DN	Racord etanșare	d, ø [mm]	EUR/buc.
359.100.00.1	90	Oțel CrNi 1.4301	90	207,32

Receptor de terasă Geberit Pluvia cu flanșă, pentru jgheaburi

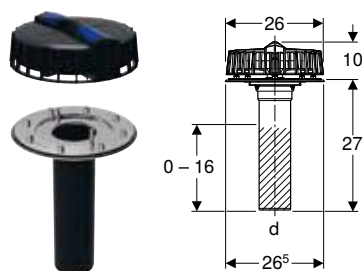

click & scan

Cod art.	DN	Racord etanșare	d, ø [mm]	EUR/buc.
359.007.00.1	90	Oțel CrNi 1.4301	90	253,47

Receptori de terasă cu capacitate de până la 100 l/s

Receptor de terasă Geberit Pluvia pentru jgheaburi

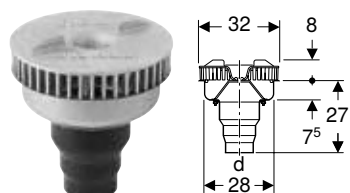

click & scan

Cod art.	DN	Racord etanșare	d, ø [mm]	Capacitate de evacuare [l/s]	EUR/buc.
359.342.00.1	100	Oțel CrNi 1.4301	110	45	324,52

Receptor de terasă Geberit Pluvia pentru jgheaburi

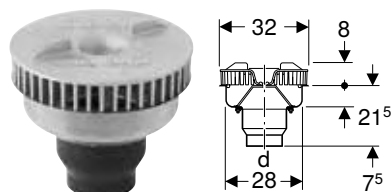

click & scan

Cod art.	DN	Racord etanșare	d, ø [mm]	Capacitate de evacuare [l/s]	EUR/buc.
359.343.00.1	125	Oțel CrNi 1.4301	125	60	324,52

Receptor de terasă Geberit Pluvia pentru jgheaburi

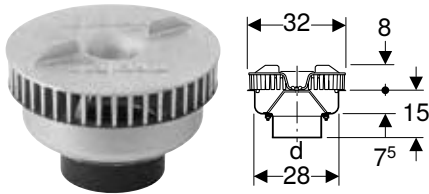

click & scan



Cod art.	DN	Racord etanșare	d, ø [mm]	Capacitate de evacuare [l/s]	EUR/buc.
359.344.00.1	155	Oțel CrNi 1.4301	160	100	324,52

Elemente barieră de vapori

Pentru receptori de terasă cu capacitate de până la 12 l/s

Conexiune cu bariera de vapori Geberit Pluvia

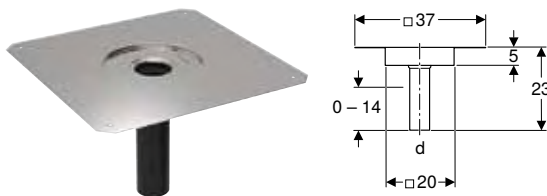

click & scan

Cod art.	DN	Racord etanșare	d, ø [mm]	EUR/buc.
359.113.00.1	56	Oțel CrNi 1.4301	56	76,99

Accesorii

- Placă de instalare Geberit Pluvia → p. 60

Pentru receptori de terasă cu capacitate de până la 25 l/s

Conexiune cu bariera de vapori Geberit Pluvia

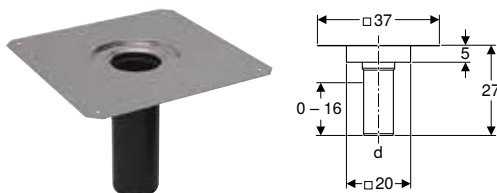

click & scan

Cod art.	DN	Racord etanșare	d, ø [mm]	EUR/buc.
359.102.00.1	90	Oțel CrNi 1.4301	90	163,84

Accesorii

- Placă de instalare Geberit Pluvia → p. 60

Instalație pluvială Geberit Pluvia

Preaplinuri de urgență

Pentru receptori de terasă cu capacitate de până la 12 l/s

Preaplinuri de urgență

Pentru receptori de terasă cu capacitate de până la 12 l/s

Preaplin de urgență Geberit Pluvia

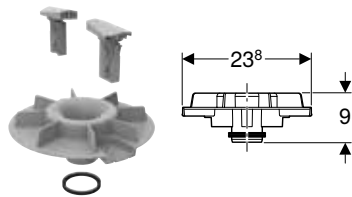

click & scan

Cod art.

359.114.00.1

EUR/buc.

51,26

Pentru receptori de terasă cu capacitate de până la 25 l/s

Preaplin de urgență Geberit Pluvia

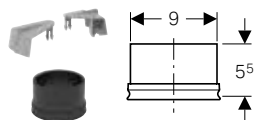

click & scan

Cod art.

359.036.00.1

EUR/buc.

69,55

Preaplin de urgență Geberit Pluvia

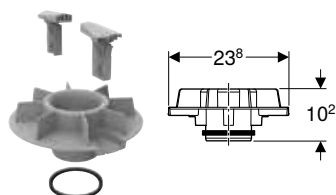

click & scan

Cod art.

359.101.00.1

EUR/buc.

64,06

Dispozitive de fixare

Sistem de fixare d40–200

Bară suport Geberit Pluvia

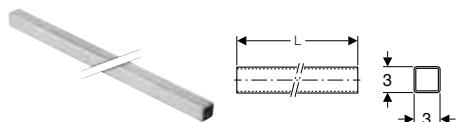

click & scan

Cod art.	Culoare/suprafață	L [m]	B [cm]	H [cm]	EUR/m
362.863.26.1	Galvanizat	5	3	3	7,84

Element de legătură Geberit Pluvia

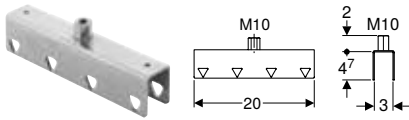

click & scan
EUR/buc.

Cod art.	Culoare/suprafață	L [cm]	
362.864.26.1	Galvanizat	20	6,20

Element de suspendare Geberit Pluvia

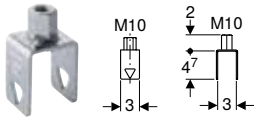

click & scan
EUR/buc.

Cod art.	Culoare/suprafață	L [cm]	
362.862.26.1	Galvanizat	6,7	2,16

Pană de fixare Geberit Pluvia

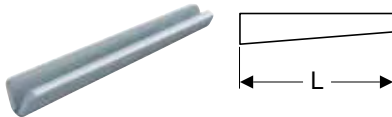

click & scan
EUR/buc.

Cod art.	Culoare/suprafață	L [cm]	
362.865.26.1	Galvanizat	9	1,28

Brățară pentru țevă Geberit Pluvia

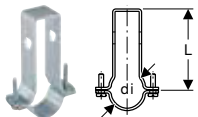

click & scan
EUR/buc.

Cod art.	Culoare/suprafață	DN	di, ø [mm]	L [cm]	
360.861.00.1	Galvanizat	40	40	10,6	6,20

Brățară pentru țevă Geberit Pluvia, reglabilă

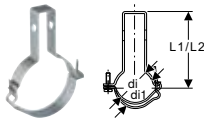

click & scan
EUR/buc.

Cod art.	Culoare/suprafață	DN	di, ø [mm]	di1, ø [mm]	L1 [cm]	L2 [cm]	
361.861.00.1	Galvanizat	50	50	58	11,3	11,7	6,20
363.861.00.1	Galvanizat	56	56	64	11,7	12,1	6,45
364.861.00.1	Galvanizat	60	63	71	12,1	12,5	6,45
365.861.00.1	Galvanizat	70	75	83	12,8	13,2	7,08
366.861.00.1	Galvanizat	90	90	98	13,6	14	7,08
367.861.00.1	Galvanizat	100	110	118	14,7	15,1	7,60
368.861.00.1	Galvanizat	125	125	133	15,5	15,9	7,84
369.861.00.1	Galvanizat	150	160	168	17,3	17,7	8,46

Instalație pluvială Geberit Pluvia

Preaplinuri de urgență
Sistem de fixare d250–315

Brățară pentru țevă Geberit Pluvia, reglabilă, cu etrier de siguranță

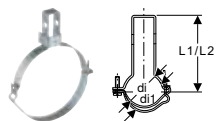

click & scan
EUR/buc.

Cod art.	Culoare/suprafață	DN	di, ø [mm]	di1, ø [mm]	L1 [cm]	L2 [cm]	
370.861.26.1	Galvanizat	200	200	208	19,4	19,8	26,13

Bandă de electrofuziune Geberit pentru punct fix

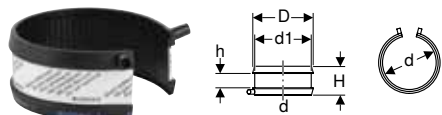

click & scan
EUR/buc.

Cod art.	DN	d, ø [mm]	d1, ø [mm]	D [cm]	H [cm]	h [cm]	
361.776.16.1	50	50	58	6,6	6	3	10,56
363.776.16.1	56	56	64	7,2	6	3	11,52
364.776.16.1	60	63	71	7,9	6	3	11,52
365.776.16.1	70	75	83	9,1	6	3	12,59
366.776.16.1	90	90	98	10,6	6	3	14,40
367.776.16.1	100	110	118	12,6	6	3	15,83
368.776.16.1	125	125	133	14,1	6	3	17,87
369.776.16.1	150	160	168	17,6	6	3	20,98
370.776.16.1	200	200	208	21,6	6	3	25,29
371.776.16.1	250	250	258	26,6	6	3	31,64

Sistem de fixare d250–315

Bară suport Geberit Pluvia

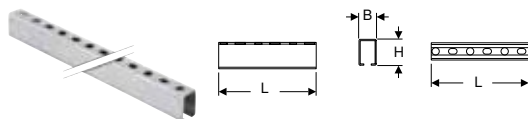

click & scan
EUR/m

Cod art.	L [m]	B [cm]	H [cm]	
363.863.00.1	5	4	6	44,02

Element de legătură Geberit Pluvia

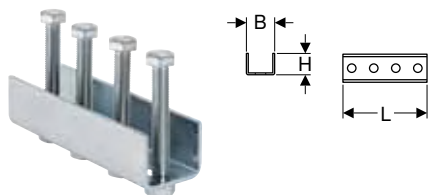

click & scan

Cod art.	L [cm]	B [cm]	H [cm]	EUR/buc.
363.864.00.1	16	4,5	4	42,63

Element de suspendare Geberit Pluvia



click & scan

Cod art.	EUR/buc.
363.862.00.1	3,43

Brățară pentru țevă Geberit Pluvia cu bandă de electrofuziune pentru punct fix

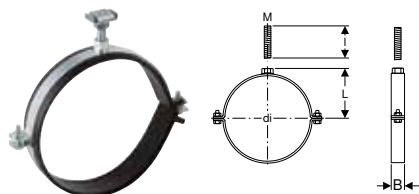

click & scan

Cod art.	Culoare/suprafață	DN	M [mm]	di, ø [mm]	L [cm]	l [cm]	B [cm]	EUR/buc.
371.861.00.1	Galvanizat	250	16	250	14,8	6	3	64,82

Set de brățări pentru țevă Geberit Pluvia cu bandă de electrofuziune pentru punct fix

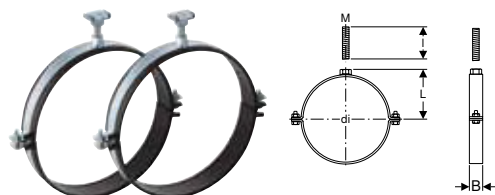

click & scan

Cod art.	Culoare/suprafață	DN	M [mm]	di, ø [mm]	L [cm]	l [cm]	B [cm]	EUR/buc.
372.861.00.1	Galvanizat	300	16	315	18	6	3	143,25

Brățară pentru țevă Geberit Pluvia cu mufă M16

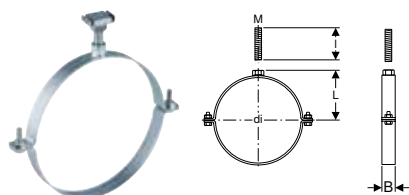

click & scan

Cod art.	Culoare/suprafață	DN	M [mm]	di, ø [mm]	L [cm]	l [cm]	B [cm]	EUR/buc.
371.862.00.1	Galvanizat	250	16	250	14,8	6	3	28,77
372.862.00.1	Galvanizat	300	16	315	18	6	3	31,91

Accesorii

Pentru receptori de terasă

Corp foliat Geberit Pluvia pentru bitum

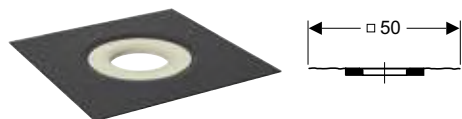

click & scan
EUR/buc.

Cod art.	Racord etanșare	EUR/buc.
358.033.00.1	Bitum (Sopralen EP5)	62,84

Placă de instalare Geberit Pluvia



click & scan
EUR/buc.

Cod art.	s [mm]	EUR/buc.
359.122.00.1	1,5	40,14

Placă de instalare pentru receptor de terasă Geberit Pluvia cu flanșă de conectare, pentru folii de hidroizolație

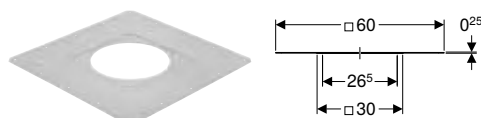

click & scan
EUR/buc.

Cod art.	Culoare/suprafață	s [mm]	EUR/buc.
359.006.25.1	Galvanizat la cald	1,5	40,14

Folie de contact universală Geberit Pluvia

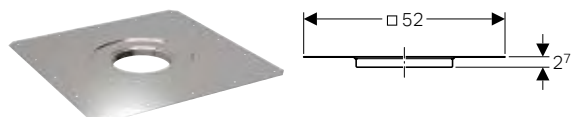

click & scan
EUR/buc.

Cod art.	Racord etanșare	s [mm]	EUR/buc.
359.119.00.1	Oțel CrNi 1.4404	1	77,33

Fixare receptor Geberit Pluvia

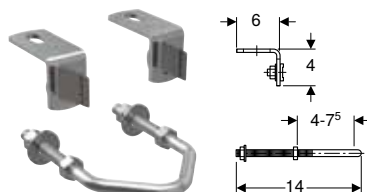

click & scan

Cod art.	EUR/buc.
358.829.00.1	17,04

Instalație de încălzire Geberit Pluvia 230 V / 8 W



click & scan

Cod art.	d, ø [mm]	D [cm]	H [cm]	EUR/buc.
359.971.00.1	56	9,7	6	143,25

Bandă de încălzire Geberit, 230 V / 11,2 W



click & scan

Cod art.	EUR/buc.
359.042.00.1	99,19

Set de completare Geberit Pluvia, care suportă greutate

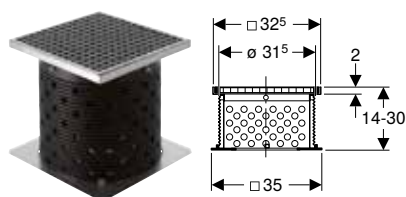

click & scan

Cod art.	d, ø [mm]	EUR/buc.
359.635.00.1	31,5	253,36

Set de completare Geberit Pluvia, pentru terase circulabile

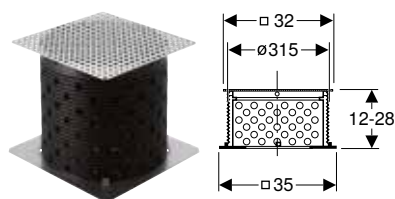

click & scan

Cod art.	d, ø [mm]	EUR/buc.
359.504.00.1	31,5	151,63

Inel filtru pentru pietriș Geberit Pluvia

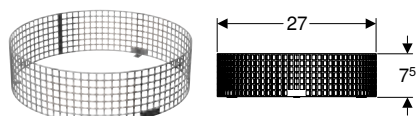

click & scan

Cod art.	EUR/buc.
359.124.00.1	67,56

Instalație pluvială Geberit Pluvia

Accesorii

Pentru dispozitive de fixare

Termoizolație Geberit Pluvia

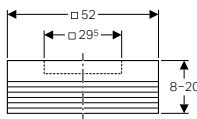

click & scan
EUR/buc.

Cod art.	d, ø [mm]	EUR/buc.
359.123.00.1	56	116,40

Pentru dispozitive de fixare

Set de fixare Geberit Pluvia



click & scan

Cod art.	DN	d, ø [mm]	EUR/buc.
358.061.00.1	90–200	90–200	35,07

De comandat suplimentar

- Țeavă filetată G 1/2" L200 galvanizată (cod articol 362.852.26.1)

Set de fixare Geberit Pluvia



click & scan

Cod art.	DN	d, ø [mm]	EUR/buc.
358.062.00.1	250–300	250–315	52,72

De comandat suplimentar

- Țeavă filetată G 1/2" L200 galvanizată (cod articol 362.852.26.1)





Geberit Silent-db20



Țevi	66
Fitinguri	66
Coturi	66
Ramificații	68
Reducții	73
Piese de curățire	74
Conexiuni	75
Îmbinări prin sudură	75
Îmbinări prin mufare	75
Conexiuni prin strângere	75
Adaptoare la alte materiale	76
Racorduri de aparate	77
Coturi de conectare	77
Mufe de racordare cu inel de etanșare	78
Sifoane tip P	78
Accesorii	78
Brățări pentru conducte	78
Dispozitive de fixare pentru brățări pentru conducte	79
Dispozitive de închidere	80
Etanșări	80
Materiale consumabile	81

Țevi

Țeavă Geberit Silent-db20

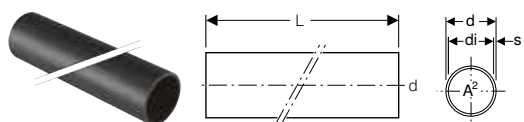

click & scan
EUR/m

Cod art.	DN	d, ø [mm]	di, ø [mm]	s [mm]	L [cm]	L [m]	A² [cm²]	EUR/m
305.000.14.1	56	56	49,6	3,2	300	3	19,3	9,20
306.000.14.1	60	63	56,6	3,2	300	3	25,1	10,63
307.000.14.1	70	75	67,8	3,6	300	3	36,1	13,50
308.000.14.1	90	90	79	5,5	300	3	49	20,82
310.000.14.1	100	110	98	6	300	3	75,4	23,68
312.000.14.1	125	135	123	6	300	3	118,7	31,28
315.001.14.1	150	160	146	7	300	3	167,4	52,69

Fitinguri

Coturi

Cot Geberit Silent-db20

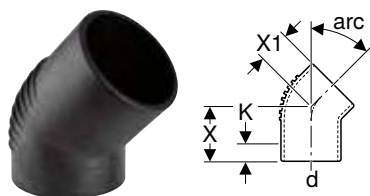

click & scan

Cod art.	DN	d, ø [mm]	X [cm]	X1 [cm]	K [cm]	EUR/buc.
arc / cot: 15°						
305.150.14.1	56	56	7,5	4,5	3,5	5,05
306.150.14.1	60	63	7,5	5	3,5	5,88
307.150.14.1	70	75	8	5	3,5	5,88
308.150.14.1	90	90	10	5,5	5,5	10,56
310.150.14.1	100	110	10	6	5,5	10,56
312.150.14.1	125	135	11,5	6,5	6,5	24,22
315.150.14.1	150	160	13	7,5	8	31,16
arc / cot: 30°						
305.300.14.1	56	56	7,5	4,5	3,5	5,05
306.300.14.1	60	63	7,5	5	3	5,88
307.300.14.1	70	75	8	5	3,5	5,88
308.300.14.1	90	90	10	6,5	4,5	10,56
310.300.14.1	100	110	10	6	4,5	10,56
312.300.14.1	125	135	11,5	6,5	6	20,02
315.300.14.1	150	160	15,7	15,7	7	31,16
arc / cot: 45°						
305.450.14.1	56	56	7,5	4,5	3	5,05
306.450.14.1	60	63	7,5	5	2,5	5,88
307.450.14.1	70	75	8	5	2,5	5,88
308.450.14.1	90	90	10	5,5	4	10,56
310.450.14.1	100	110	10	6	4	10,56
312.450.14.1	125	135	11,5	7,7	5	18,69
315.450.14.1	150	160	15,5	9,5	8	30,82
arc / cot: 67°						
305.670.14.1	56	56	7,5	5,5	2	5,05
307.670.14.1	70	75	8	6	2	5,88
308.670.14.1	90	90	10	7	3	14,87
310.670.14.1	100	110	10	8	2,5	10,56

Cot cu umăr lung Geberit Silent-db20

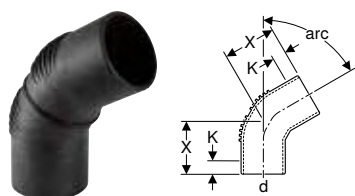

click & scan

Cod art.	DN	d, ø [mm]	X [cm]	K [cm]	EUR/buc.
arc / cot: 60°					
305.600.14.1	56	56	9,1	3,5	16,31
306.600.14.1	60	63	9,7	3	20,26
307.600.14.1	70	75	11,3	3,5	20,26
308.600.14.1	90	90	13,8	4,5	34,75
310.600.14.1	100	110	14,6	4,5	34,75
312.600.14.1	125	135	16,9	6	45,16
arc / cot: 88,5°					
305.885.14.1	56	56	11	3	16,31
306.885.14.1	60	63	11,5	2,5	20,26
307.885.14.1	70	75	12,8	2,5	20,26
308.885.14.1	90	90	15,6	4	34,75
310.885.14.1	100	110	16,9	4	34,75
312.885.14.1	125	135	18,6	5	38,93
315.885.14.1	150	160	22,5	8	70,14

Cot 88,5° Geberit Silent-db20

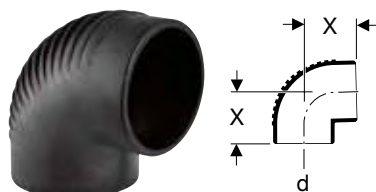

click & scan

Cod art.	DN	d, ø [mm]	arc [°]	X [cm]	EUR/buc.
305.880.14.1	56	56	88,5	6,5	5,05
306.880.14.1	60	63	88,5	7	5,88
307.880.14.1	70	75	88,5	7,5	5,88
308.880.14.1	90	90	88,5	8	10,56
310.880.14.1	100	110	88,5	9,5	10,56
312.880.14.1	125	135	88,5	11,5	20,02

Cot cu umăr lung 45° Geberit Silent-db 20°

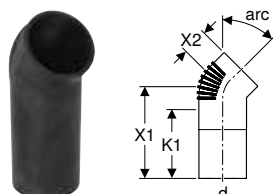

click & scan

Cod art.	DN	d, ø [mm]	arc [°]	X1 [cm]	X2 [cm]	K1 max. [cm]	EUR/buc.
308.014.14.1	90	90	45	21	5,5	15,5	21,94
310.014.14.1	100	110	45	21	6	15	22,41
312.014.14.1	125	135	45	22,5	7,7	16	32,83

Cot cu umăr lung 90° Geberit Silent-db20

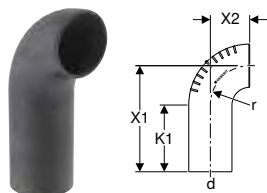

click & scan

Cod art.	DN	d, ø [mm]	arc [°]	X1 [cm]	X2 [cm]	K1 max. [cm]	r [cm]	EUR/buc.
306.008.14.1	60	63	90	21	5	12,6	5	20,26
310.008.14.1	100	110	90	27	10	13,6	10	34,75

Geberit Silent-db20 fitting offset

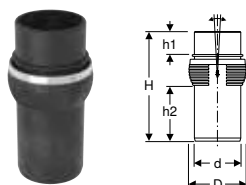

click & scan

Cod art.	Culoare/suprafață	DN	d, ø [mm]	D [cm]	H [cm]	h2 [cm]	h1 [cm]	EUR/buc.
310.048.14.1	Negru mat	100	110	13,6	26	13	5,3	48,31

Ramificații

Ramificație 45° Geberit Silent-db20

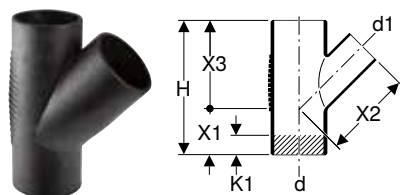

click & scan

Cod art.	DN	d, ø [mm]	d1, ø [mm]	arc [°]	H [cm]	X1 [cm]	X2 [cm]	X3 [cm]	K1 max. [cm]	EUR/buc.
305.054.14.1	56 / 56	56	56	45	18	6	12	12	1,5	6,49
306.054.14.1	60 / 56	63	56	45	19,5	6,5	13	13	2	8,64
306.064.14.1	60 / 60	63	63	45	19,5	6,5	13	13	2	8,64
307.054.14.1	70 / 56	75	56	45	21	7	14	14	3,5	9,60
307.064.14.1	70 / 60	75	63	45	21	7	14	14	3	9,60
307.074.14.1	70 / 70	75	75	45	21	7	14	14	2	9,60
308.054.14.1	90 / 56	90	56	45	24	8	16	16	5	15,83
308.064.14.1	90 / 60	90	63	45	24	8	16	16	5	15,83
308.074.14.1	90 / 70	90	75	45	24	8	16	16	4	15,83
308.084.14.1	90 / 90	90	90	45	24	8	16	16	2,5	15,83
310.054.14.1	100 / 56	110	56	45	27	9	18	18	7	17,87
310.064.14.1	100 / 60	110	63	45	27	9	18	18	6,5	17,87
310.074.14.1	100 / 70	110	75	45	27	9	18	18	5,5	17,87
310.084.14.1	100 / 90	110	90	45	27	9	18	18	4,5	17,87
310.104.14.1	100 / 100	110	110	45	27	9	18	18	3	17,87
312.104.14.1	125 / 100	135	110	45	34,5	11,5	23	23	6,5	29,60
312.124.14.1	125 / 125	135	135	45	34,5	11,5	23	23	5	35,71
315.144.14.1	150 / 150	160	160	45	41,5	14	27,5	27,5	7	86,63

Ramificație 45° Geberit Silent-db20

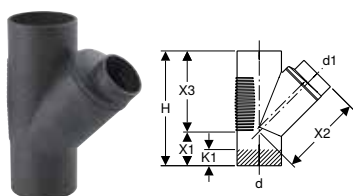

click & scan

Cod art.	DN	d, ø [mm]	d1, ø [mm]	arc [°]	H [cm]	X1 [cm]	X2 [cm]	X3 [cm]	K1 max. [cm]	EUR/buc.
315.104.14.1	150 / 100	160	110	45	41,5	10,6	30	30,9	7	114,27
315.124.14.1	150 / 125	160	135	45	41,5	12,4	29,7	29,1	7	192,71



Ramificație cot 88,5° Geberit Silent-db20

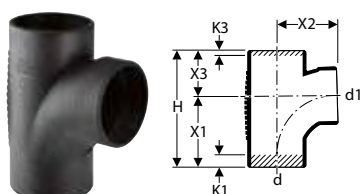

click & scan

Cod art.	DN	d, ø [mm]	d1, ø [mm]	arc [°]	H [cm]	X1 [cm]	X2 [cm]	X3 [cm]	K1 max. [cm]	K3 max. [cm]	EUR/buc.
308.089.14.1	90 / 90	90	90	88,5	20,4	12	10,5	8,3	1,5	0,5	14,26
310.088.14.1	100 / 90	110	90	88,5	22,5	13,5	11,5	9	4	1	17,87
310.108.14.1	100 / 100	110	110	88,5	22,5	13,5	11,5	9	2,5	0	17,87
312.109.14.1	125 / 100	135	110	88,5	22,6	13,5	11,5	9,1	2,5	0	32,36

Ramificație 88,5° Geberit Silent-db20

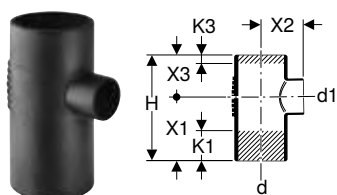

click & scan

Cod art.	DN	d, ø [mm]	d1, ø [mm]	arc [°]	H [cm]	X1 [cm]	X2 [cm]	X3 [cm]	K1 max. [cm]	K3 max. [cm]	EUR/buc.
305.058.14.1	56 / 56	56	56	88,5	17,5	10,5	7	7	4,5	0,5	6,49
306.058.14.1	60 / 56	63	56	88,5	17,5	10,5	7	7	4,5	0,5	8,64
306.068.14.1	60 / 60	63	63	88,5	17,5	10,5	7	7	4	0	8,64
307.058.14.1	70 / 56	75	56	88,5	18	10,5	7	7,5	4,5	0,5	9,60
307.068.14.1	70 / 60	75	63	88,5	18	10,5	7,5	7,5	4	0	9,60
307.078.14.1	70 / 70	75	75	88,5	18	10,5	7,5	7,5	3,5	0	9,60
308.058.14.1	90 / 56	90	56	88,5	20,3	12	8	8,3	6	2	15,83
308.068.14.1	90 / 60	90	63	88,5	20,3	12	8	8,3	5,5	1,5	15,83
308.078.14.1	90 / 70	90	75	88,5	20,3	12	8	8,3	5	1	15,83
308.088.14.1	90 / 90	90	90	88,5	20,3	12	8,3	8,3	4,5	0,5	15,83
310.058.14.1	100 / 56	110	56	88,5	22,5	13,5	9	9	7,5	3	17,87
310.068.14.1	100 / 60	110	63	88,5	22,5	13,5	9	9	7	2,5	17,87
310.078.14.1	100 / 70	110	75	88,5	22,5	13,5	9	9	6,5	1,5	17,87
312.108.14.1	125 / 100	135	110	88,5	28,8	17,3	11,5	11,5	8,5	2,5	29,35
312.128.14.1	125 / 125	135	135	88,5	28,8	17,3	11,5	11,5	7,5	1,5	33,78
315.148.14.1	150 / 150	160	160	88,5	33,5	18,5	15	15	7	3	95,94

Ramificație 88,5° Geberit Silent-db20

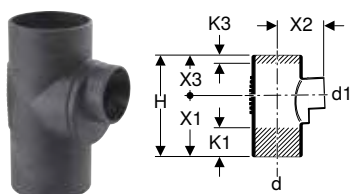

click & scan

Cod art.	DN	d, ø [mm]	d1, ø [mm]	arc [°]	H [cm]	X1 [cm]	X2 [cm]	X3 [cm]	K1 max. [cm]	K3 max. [cm]	EUR/buc.
315.108.14.1	150 / 100	160	110	88,5	33,5	21	15	12,5	7	1,5	160,36
315.128.14.1	150 / 125	160	135	88,5	33,5	19,5	16	14	7	1,5	84,93

Ramificație cot 88,5° Geberit Silent-db20, dublu

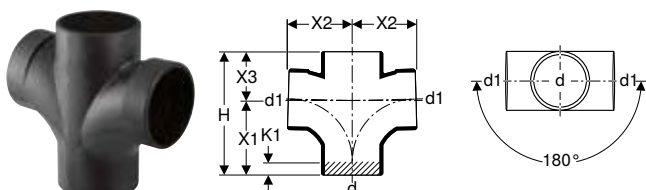

click & scan

Cod art.	DN	d, ø [mm]	d1, ø [mm]	arc [°]	H [cm]	X1 [cm]	X2 [cm]	X3 [cm]	K1 max. [cm]	EUR/buc.
308.082.14.1	90	90	90	88,5	20,3	12	10,5	8,3	1,5	51,98
310.102.14.1	100	110	110	88,5	22,5	13,5	11,5	9	2,5	51,52

Cot de ramificație de colț Geberit Silent-db20, 88,5° / 90°

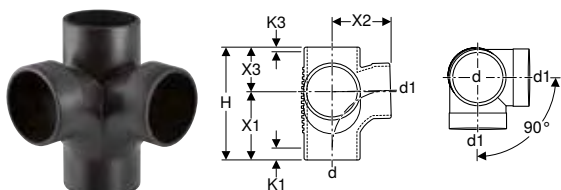

click & scan

Cod art.	DN	d, ø [mm]	d1, ø [mm]	arc [°]	H [cm]	X1 [cm]	X2 [cm]	X3 [cm]	K1 max. [cm]	K3 max. [cm]	EUR/buc.
310.083.14.1	100 / 100	110	110	88,5	22,6	13,6	11,5	9	2,5	0	56,66

Ramificație cot colț 88,5° / 135° Geberit Silent-db20

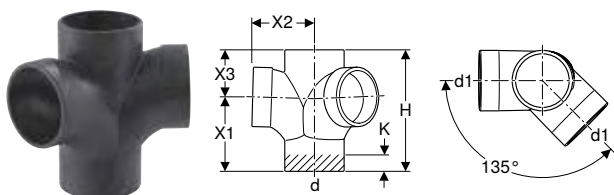

click & scan

Cod art.	DN	d, ø [mm]	d1, ø [mm]	arc [°]	arc2 [°]	H [cm]	X1 [cm]	X2 [cm]	X3 [cm]	K [cm]	EUR/buc.
310.105.14.1	100 / 100	110	110	88,5	135	22,5	13,5	11,5	9	2	54,50

Ramificație Geberit Silent-db20 88.5° cvadruplu

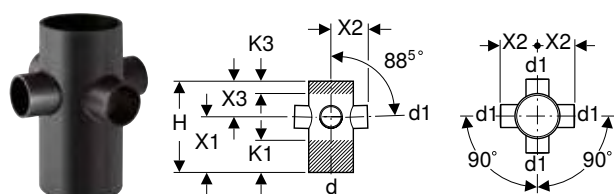

click & scan

Cod art.	DN	d, ø [mm]	d1, ø [mm]	arc [°]	H [cm]	X1 [cm]	X2 [cm]	X3 [cm]	K1 max. [cm]	K3 max. [cm]	EUR/buc.
310.445.14.1	100 / 56	110	56	88,5	22,5	13,5	9	9	7,5	3	83,41

Ramificație cot combi 88,5° Geberit Silent-db20

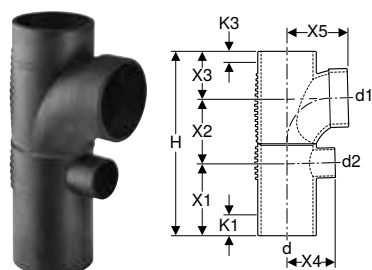

click & scan

Cod art.	DN	d, ø [mm]	d1, ø [mm]	d2, ø [mm]	arc [°]	H [cm]	X1 [cm]	X2 [cm]	X3 [cm]	X4 [cm]	X5 [cm]	K1 max. [cm]	K3 max. [cm]	EUR/buc.
308.811.14.1	90 / 90 / 56	90	90	56	88,5	31,6	12	11,3	8,3	8	10,5	6	0,5	56,78
310.811.14.1	100 / 90 / 56	110	90	56	88,5	33,8	13,5	11,3	9	9	11,5	7,5	1	56,78
310.813.14.1	100 / 100 / 56	110	110	56	88,5	34,8	13,5	12,3	9	9	11,5	7,5	0	56,78

Ramificație cot combinat Geberit Silent-db20 88,5° stânga

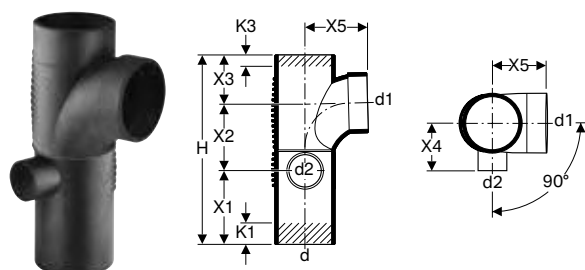

click & scan

Cod art.	DN	d, ø [mm]	d1, ø [mm]	d2, ø [mm]	arc [°]	H [cm]	X1 [cm]	X2 [cm]	X3 [cm]	X4 [cm]	X5 [cm]	K1 max. [cm]	K3 max. [cm]	EUR/buc.
308.817.14.1	90 / 90 / 56	90	90	56	88,5	31,6	12	11,3	8,3	8	10,5	6	0,5	56,84
310.817.14.1	100 / 90 / 56	110	90	56	90	33,8	13,5	11,3	9	9	11,5	7,5	1	59,78
310.117.14.1	100 / 100 / 56	110	110	56	90	34,8	13,5	12,3	9	9	11,5	7,5	0	59,78

Ramificație cot combinat Geberit Silent-db20 88,5° dreapta

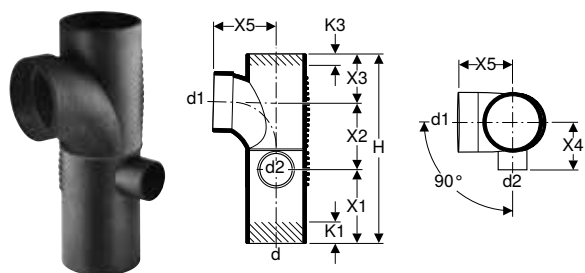

click & scan

Cod art.	DN	d, ø [mm]	d1, ø [mm]	d2, ø [mm]	arc [°]	H [cm]	X1 [cm]	X2 [cm]	X3 [cm]	X4 [cm]	X5 [cm]	K1 max. [cm]	K3 max. [cm]	EUR/buc.
308.815.14.1	90 / 90 / 56	90	90	56	88,5	31,6	12	11,3	8,3	8	10,5	6	0,5	56,84
310.815.14.1	100 / 90 / 56	110	90	56	88,5	33,8	13,5	11,3	9	9	11,5	7,5	1	59,78
310.115.14.1	100 / 100 / 56	110	110	56	88,5	34,8	13,5	12,3	9	9	11,5	7,5	0	59,78

Cot de ramificație cămin 88,5° Geberit Silent-db20, stânga

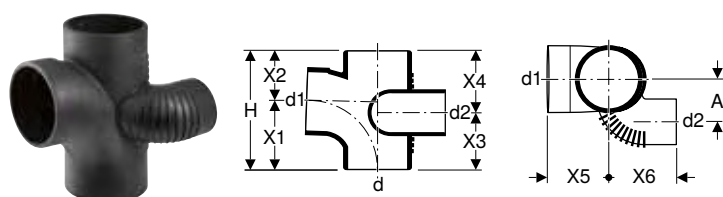

click & scan

Cod art.	DN	d, ø [mm]	d1, ø [mm]	d2, ø [mm]	arc [°]	A [cm]	H [cm]	X1 [cm]	X2 [cm]	X3 [cm]	X4 [cm]	X5 [cm]	X6 [cm]	EUR/buc.
308.874.14.1	N 90 / 90 / 56	90	90	56	88,5	8,1	20,4	12	8,3	11,1	9,3	10,7	14,2	68,28
310.874.14.1	N 110 / 90 / 56	110	90	56	88,5	7,7	22,6	13,5	9	11,9	10,7	11,6	8,8	78,22
308.872.14.1	90 / 90 / 70	90	90	75	88,5	8,1	20,3	12	8,3	12	8,3	10,6	14,2	66,12
310.872.14.1	100 / 90 / 70	110	90	75	88,5	7,7	22,5	13,5	9	12,8	9,7	11,5	9,3	68,28
310.172.14.1	100 / 100 / 70	110	110	75	88,5	7,7	22,5	13,5	9	11,8	10,7	11,5	9,3	70,31

N: Nou, livrabil din April 2024

Cot de ramificație cămin 88,5° Geberit Silent-db20, dreapta

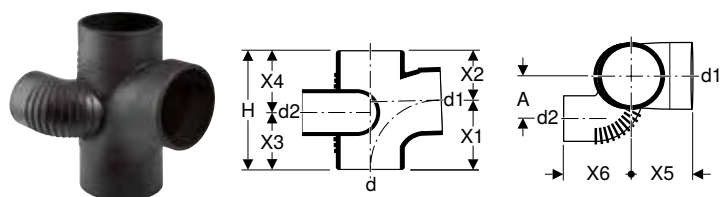

click & scan

Cod art.	DN	d, ø [mm]	d1, ø [mm]	d2, ø [mm]	arc [°]	A [cm]	H [cm]	X1 [cm]	X2 [cm]	X3 [cm]	X4 [cm]	X5 [cm]	X6 [cm]	EUR/buc.
308.875.14.1	N 90 / 90 / 56	90	90	56	88,5	8,1	20,4	12	8,3	11,1	9,3	10,7	14,2	68,28
310.875.14.1	N 110 / 90 / 56	110	90	56	88,5	7,7	22,6	13,5	9	11,9	10,7	11,6	8,8	78,22
308.871.14.1	90 / 90 / 70	90	90	75	88,5	8,1	20,3	12	8,3	12	8,3	10,6	14,2	66,12
310.871.14.1	100 / 90 / 70	110	90	75	88,5	7,7	22,5	13,5	9	12,8	9,7	11,5	9,3	68,28
310.171.14.1	100 / 100 / 70	110	110	75	88,5	7,7	22,5	13,5	9	11,8	10,7	11,5	9,3	70,31

N: Nou, livrabil din April 2024

Ramificație paralelă 45° Geberit Silent-db20

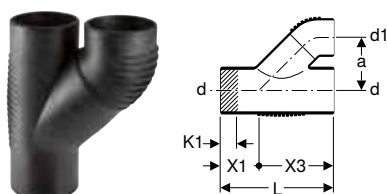

click & scan

Cod art.	DN	d, ø [mm]	d1, ø [mm]	arc [°]	a [cm]	L [cm]	X1 [cm]	X2 [cm]	X3 [cm]	K1 max. [cm]	EUR/buc.
308.081.14.1	90 / 90	90	90	45	11	24	8	16	16	2,5	47,20
310.081.14.1	100 / 90	110	90	45	12,5	27	9	18	18	4,5	50,43
310.101.14.1	100 / 100	110	110	45	12,5	27	9	18	18	3	50,43

Ramificație pantalon 2 x 90° Geberit Silent-db20

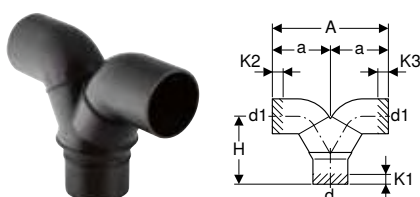

click & scan

Cod art.	DN	d, ø [mm]	d1, ø [mm]	arc [°]	A [cm]	a [cm]	H [cm]	K1 max. [cm]	K2 max. [cm]	K3 max. [cm]	EUR/buc.
308.480.14.1	90 / 90	90	90	90	30	15	17,5	4	2	2	110,19
310.481.14.1	100 / 90	110	90	90	30	15	17,5	4	2	2	116,99

Reducții

Reducție excentrică Geberit Silent-db20, scurtă

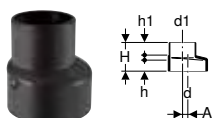

click & scan

EUR/buc.

Cod art.	DN	d, ø [mm]	d1, ø [mm]	A [cm]	H [cm]	h [cm]	h1 [cm]	EUR/buc.
306.050.14.1	60 / 56	63	56	0,4	8	3,4	3,7	5,88
307.050.14.1	70 / 56	75	56	0,9	8	3,3	3,7	5,88
307.060.14.1	70 / 60	75	63	0,6	8	3,3	3,7	5,88
308.050.14.1	90 / 56	90	56	1,5	8	3,1	3,7	7,45
308.060.14.1	90 / 60	90	63	1,1	8	3,1	3,7	7,45
308.070.14.1	90 / 70	90	75	0,6	8	3,3	3,7	7,45

Reducție excentrică Geberit Silent-db20

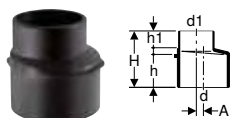

click & scan

EUR/buc.

Cod art.	DN	d, ø [mm]	d1, ø [mm]	A [cm]	H [cm]	h [cm]	h1 [cm]	EUR/buc.
310.050.14.1	100 / 56	110	56	2,4	11	6	3,7	8,04
310.060.14.1	100 / 60	110	63	2,1	11	6,1	3,7	8,04
310.070.14.1	100 / 70	110	75	1,5	11	6	3,7	8,04
310.080.14.1	100 / 90	110	90	1	11	6,1	3,7	8,04
312.100.14.1	125 / 100	135	110	1,3	11	6,1	3,7	23,74
312.125.14.1	125 / 125	135	125	0,4	11	6	3,7	23,12
315.100.14.1	150 / 100	160	110	2,4	12,6	8	3,8	31,64
315.126.14.1	150 / 125	160	135	1,1	13,5	8	4,7	73,31

Reducție centrică Geberit Silent-db20

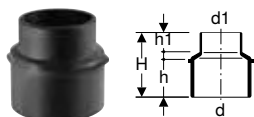

click & scan
EUR/buc.

Cod art.	DN	d, ø [mm]	d1, ø [mm]	H [cm]	h [cm]	h1 [cm]	EUR/buc.
310.052.14.1	100 / 56	110	56	11	6,1	3,7	9,48
310.062.14.1	100 / 60	110	63	11	6,1	3,7	9,48
310.072.14.1	100 / 70	110	75	11	6,1	3,7	9,72
310.082.14.1	100 / 90	110	90	11	6,1	3,7	9,72

Reducție centrică Geberit Silent-db20, lungă

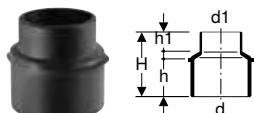

click & scan
EUR/buc.

Cod art.	DN	d, ø [mm]	d1, ø [mm]	H [cm]	h [cm]	h1 [cm]	EUR/buc.
310.106.14.1	125 / 100	125	110	13	8,5	3,7	26,37

Piese de curățire

Piesă de curățare 45° Geberit Silent-db20 cu orificiu de service rotund

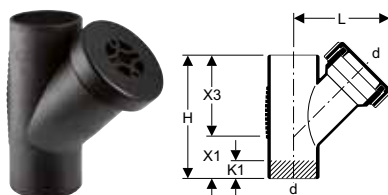

click & scan

Cod art.	DN	d, ø [mm]	arc [°]	L [cm]	H [cm]	X1 [cm]	X2 [cm]	X3 [cm]	K1 max. [cm]	EUR/buc.
307.345.14.1	70	75	45	15,5	21	7	14	14	2	46,96
310.345.14.1	100	110	45	19	27	9	18	18	3	46,96

Piesă de curățare 90° Geberit Silent-db20 cu orificiu de service rotund

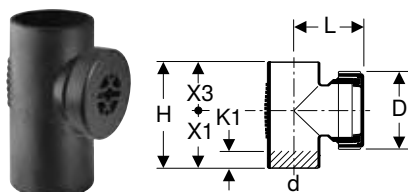

click & scan

Cod art.	DN	d, ø [mm]	arc [°]	D [cm]	L [cm]	H [cm]	X1 [cm]	X3 [cm]	K1 max. [cm]	EUR/buc.
307.333.14.1	70	75	90	11,5	10	17,5	10,5	7	3,5	22,17
308.333.14.1	90	90	90	12,9	11,5	20,3	12	8,3	1,5	22,17
310.334.14.1	100	110	90	14,5	9	24	13,5	10,5	2,5	24,22
312.333.14.1	125	135	90	14,5	13	28,8	17,3	11,5	8,5	46,12
315.333.14.1	150	160	90	14,4	13,9	33,5	18,5	15	7	106,91

Conexiuni

Îmbinări prin sudură

Mufă de electrofuziune Geberit



click & scan
EUR/buc.

Cod art.	DN	d, ø [mm]	D [cm]	E [cm]	H [cm]	X [cm]	EUR/buc.
363.771.16.1	56	56	6,8	2,8	6	0,3	5,64
364.771.16.1	60	63	7,6	2,8	6	0,3	6,13
365.771.16.1	70	75	8,9	2,8	6	0,3	6,73
366.771.16.1	90	90	10,4	2,8	6	0,3	7,21
367.771.16.1	100	110	12,5	2,8	6	0,3	8,40
312.771.16.1	125	135	15	2,8	6	0,3	11,52
369.771.16.1	150	160	17,8	2,8	6	0,3	12,24

Îmbinări prin mufare

Mufă de dilatație Geberit Silent-db20 cu colier dublu

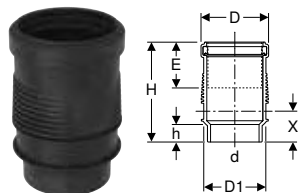

click & scan

Cod art.	DN	d, ø [mm]	D [cm]	D1 [cm]	E [cm]	H [cm]	h [cm]	X [cm]	EUR/buc.
307.012.14.1	70	75	9,8	9	8,8	20	3,7	6,2	17,38
308.012.14.1	90	90	11,4	11	8,8	20	3,4	6,2	24,22
310.012.14.1	100	110	13,5	12,5	9	20	3,3	6,2	24,22
312.012.14.1	125	135	16,8	16	9,5	20,8	3,3	6,2	33,78
315.012.14.1	150	160	19,5	17,8	9,8	21,5	3,5	7,1	48,76



- Compatibilitatea [3] nu mai este continuată. Ca alternativă este disponibilă compatibilitatea [2XL]

Conexiuni prin strângere

Element de prindere Geberit Silent-db20

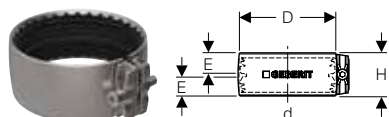

click & scan
EUR/buc.

Cod art.	DN	d, ø [mm]	D [cm]	E [cm]	H [cm]	EUR/buc.
305.003.14.3	56	56	6,7	2,4	5,2	5,40
307.003.14.3	70	75	8,6	2,4	5,2	5,40
308.003.14.3	90	90	10,1	2,4	5,2	6,49
310.003.14.3	100	110	12	2,4	5,2	6,49
312.003.14.3	125	135	14,8	3,2	6,7	7,45
315.003.14.3	150	160	17,2	3,2	6,7	14,40

Adaptoare la alte materiale

Mufă de adaptare Geberit pentru Geberit Silent-db20

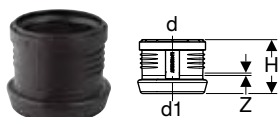

click & scan
EUR/buc.

Cod art.	DN	d, ø [mm]	d1, ø [mm]	H [cm]	Z [cm]	
390.296.14.1	50 / 56	50	56	8,7	0,3	6,05
390.396.14.1	70 / 70	75	75	9,2	0,3	9,06
390.496.14.1	90 / 90	90	90	9,7	0,3	9,93
390.596.14.1	100 / 100	110	110	10,4	0,3	10,19
390.696.14.1	125 / 125	125	135	12	0,3	27,49
390.796.14.1	150 / 150	160	160	13,6	0,4	60,12

Element de prindere cu reducție Geberit

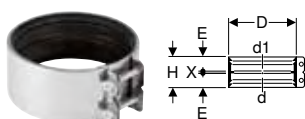

click & scan
EUR/buc.

Cod art.	DN	d, ø [mm]	d1, ø [mm]	D [cm]	E [cm]	H [cm]	X [cm]	
359.425.00.2	50	54-56	54-56	7,5	2,7	5,7	0,3	12,95
359.426.00.2	56	56	58	7,5	2,7	5,7	0,3	12,95
359.427.00.2	56	56	68	8,3	2,7	5,7	0,3	12,95
359.428.00.2	60	63	60	7,8	2,7	5,7	0,3	12,95
359.429.00.2	60	63-64	63-64	7,8	2,7	5,7	0,3	12,95
359.430.00.2	60	63-64	68	8,3	2,7	5,7	0,3	12,95
359.432.00.2	70	75	68	9	2,7	5,7	0,3	16,78
359.433.00.2	70	75-76	75-76	8,8	2,7	5,7	0,3	16,78
359.434.00.2	70	75-76	78	9,3	2,7	5,7	0,3	16,78
359.435.00.2	70	75-76	83-84	9,8	2,7	5,7	0,3	16,78
359.436.00.2	70	75-76	89-90	10,3	2,7	5,7	0,3	16,78
359.437.00.2	90	89-90	83-84	11,1	2,7	5,7	0,3	14,40
359.438.00.2	90	89-90	89-90	10,3	2,7	5,7	0,3	14,40
359.439.00.2	90	89-90	96	11,1	3,3	6,9	0,3	14,40
359.440.00.2	100	108-110	106	12,5	2,7	5,7	0,3	15,59
359.441.00.2	100	108-110	108-110	12,5	2,7	5,7	0,3	15,59
359.442.00.2	100	108-110	114-116	13,1	3,3	6,9	0,3	15,59
359.444.00.2	125	125	131-135	15	3,3	6,9	0,3	24,81
359.446.00.2	125	135	135	15	3,3	6,9	0,3	24,81
312.140.00.2	125	135	140	15,5	3,1	6,9	0,7	35,71
359.448.00.2	150	159-160	152	17,5	3,3	6,9	0,3	42,28
359.449.00.2	150	159-160	159-160	17,5	3,3	6,9	0,3	42,28
359.450.00.2	150	159-160	168	18,3	3,3	6,9	0,3	42,28

Racorduri de aparate

Coturi de conectare

Cot de conectare 90° Geberit Silent-db20 pentru vas WC suspendat, prelungit, cu rază mică

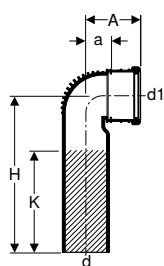

click & scan



Cod art.	DN	d, ø [mm]	d1, ø [mm]	arc [°]	A [cm]	a [cm]	H [cm]	K [cm]	EUR/buc.
308.883.14.1	90 / 90	90	90	90	11	4,9	30	19	41,45
310.883.14.1	100 / 90	110	90	90	10	4,3	30	17	42,41

Cot de conectare 90° Geberit Silent-db20 pentru vas WC suspendat, redus, cu rază mică

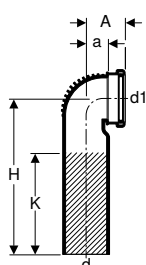

click & scan

Cod art.	DN	d, ø [mm]	d1, ø [mm]	arc [°]	A [cm]	a [cm]	H [cm]	K [cm]	EUR/buc.
308.881.14.1	90	90	90	90	7,5	3,9	30	19	32,95
310.881.14.1	90 / 100	110	90	90	7,5	4,2	30	18	35,82

Cot de conectare dublu 90° Geberit Silent-db20 pentru vas WC suspendat

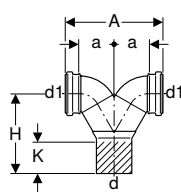

click & scan

Cod art.	DN	d, ø [mm]	d1, ø [mm]	arc [°]	A [cm]	a [cm]	H [cm]	K [cm]	EUR/buc.
308.923.14.1	90 / 90	90	90	90	25	9	20,3	6	115,23
310.923.14.1	100 / 90	110	90	90	25	9	20,3	6	113,54

Geberit Silent-db20

Accesorii

Mufe de racordare cu inel de etanșare

Cot de conectare 90° Geberit Silent-db20, prelungit

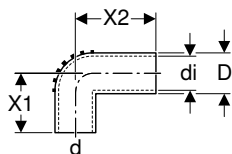

click & scan

Cod art.	DN	d, ø [mm]	arc [°]	di, ø [mm]	D [cm]	X1 [cm]	X2 [cm]	EUR/buc.
305.905.14.1	56	56	90	50	5,6	7,5	10	4,57
305.906.14.1	56	56	90	57	6,3	7,5	20	4,57

Accesorii

- Mufă Geberit → p. 39
- Mufă Geberit → p. 39

Mufe de racordare cu inel de etanșare

Mufă de racordare redusă Geberit Silent-db 20 cu inel de etanșare

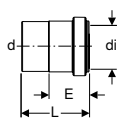

click & scan

EUR/buc.

Cod art.	DN	d, ø [mm]	di, ø [mm]	E [cm]	L [cm]	EUR/buc.
305.040.14.3	56 / 50	56	50	4,5	7,6	6,24

Sifoane tip P

Sifon tip P Geberit Silent-db20 cu mufă de electrofuziune

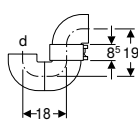

click & scan

EUR/buc.

Cod art.	DN	d, ø [mm]	a [cm]	L [cm]	H [cm]	h1 [cm]	EUR/buc.
310.850.14.1	100	110	18	32,8	29,9	19	58,71

Accesorii

Brățări pentru conducte

Brățară pentru țevă Geberit Silent-db20 cu izolație, cu piuliță conector M10 / G 1/2"

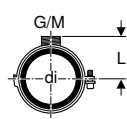

click & scan

EUR/buc.

Cod art.	DN	G ["]	M [mm]	di, ø [mm]	L [cm]	EUR/buc.
305.812.26.1	56	1/2"	10	56	4,7	5,32
306.812.26.1	60	1/2"	10	63	5	5,32
307.812.26.1	70	1/2"	10	75	5,7	5,93
308.812.26.1	90	1/2"	10	90	6,4	6,45
310.812.26.1	100	1/2"	10	110	7,4	6,45
312.812.26.1	125	1/2"	10	125	8,1	6,45
312.813.26.1	125	1/2"	10	135	8,7	7,84
315.812.26.1	150	1/2"	10	160	9,9	9,09

Brățară pentru țevă Geberit Silent-db20 cu izolație, cu piuliță conector G 1"

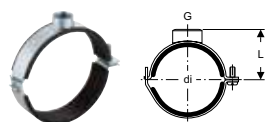

click & scan
EUR/buc.

Cod art.	DN	G ["]	di, ø [mm]	L [cm]	
315.813.26.1	150	1"	178	12	17,04

Dispozitive de fixare pentru brățări pentru conducte

Placă de fixare Geberit dreptunghiulară, două orificii, cu piuliță conector M10/G 1/2"

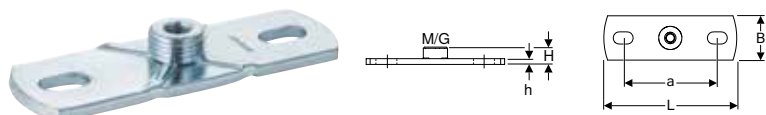

click & scan
EUR/buc.

Cod art.	G ["]	M [mm]	a [cm]	L [cm]	B [cm]	H [cm]	h [cm]	
362.851.26.1	1/2"	10	8,5	12	4	1,5	0,5	4,68

Placă de fixare Geberit dreptunghiulară, două orificii, cu piuliță conector G

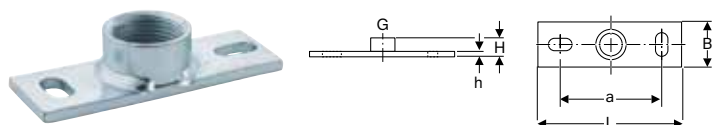

click & scan
EUR/buc.

Cod art.	G ["]	a [cm]	L [cm]	B [cm]	H [cm]	h [cm]	
362.828.26.1	1"	9	12	4	2,6	0,6	5,93

Tijă filetată Geberit



click & scan
EUR/buc.

Cod art.	M [mm]	L [cm]	
362.836.00.1	10	50	3,17

Țevă filetată Geberit

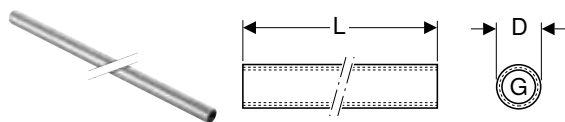

click & scan
EUR/buc.

Cod art.	G ["]	D [cm]	L [cm]	
362.857.26.1	1/2"	2,5	115	38,24

Dispozitive de închidere

Capac terminal Geberit Silent-db20



click & scan
EUR/buc.

Cod art.	DN	d, \emptyset [mm]	L [cm]	EUR/buc.
305.005.14.1	56	56	3	3,26
307.005.14.1	70	75	3	5,40
308.005.14.1	90	90	3	6,49
310.005.14.1	100	110	3	7,45
312.005.14.1	125	135	3	12,59

Capac terminal Geberit Silent-db20, înfiletabil

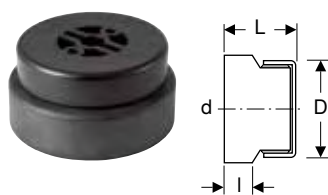

click & scan

Cod art.	DN	d, \emptyset [mm]	D [cm]	L [cm]	l [cm]	EUR/buc.
315.005.14.1	150	160	14,4	7,2	3,3	21,35

Etanșări

Mufă Geberit



click & scan
EUR/buc.

Cod art.	d, \emptyset [mm]	d1, \emptyset [mm]	L [cm]	EUR/buc.
152.498.00.1	32	40	2,5	2,17
152.796.00.1	40	44	2,3	2,18
152.495.00.1	32	46	2,3	2,17
152.496.00.1	40	46	2,3	1,95
153.564.16.1	32	58	2,3	3,68
153.565.16.1	40	58	2,3	3,43
153.566.16.1	50	58	2,3	3,43

Mufă Geberit

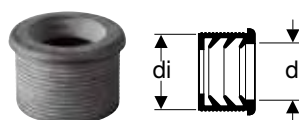

click & scan

Cod art.	DN	d, \emptyset [mm]	di, \emptyset [mm]	EUR/buc.
152.682.00.1	50	32	44	2,18
152.689.00.1	56	32	50	3,43
152.690.00.1	56	40	50	3,08
152.691.00.1	60	32	57	5,56
152.692.00.1	60	40	57	4,81
152.693.00.1	60	50	57	4,32

Materiale consumabile

Lubrifiant Geberit, 250 ml



click & scan
EUR/buc.

Cod art.		EUR/buc.
953.761.00.1		4,92

Creion de gresare Geberit cu mină retractabilă



click & scan
EUR/buc.

Cod art.	Culoare/suprafață	EUR/buc.
690.102.00.1	Galben	6,97

Protector de cofraj Geberit cu fixare integrată

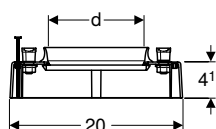

click & scan

Cod art.	DN	d, \varnothing [mm]	L [cm]	B [cm]	H [cm]	EUR/buc.
310.917.00.1	100	110	20	20	4,1	21,27



- Protectorul de cofraj trebuie îndepărtat după betonare
- Șuruburile de fixare rămân ancorate în planșeul de beton

Protector de cofraj Geberit

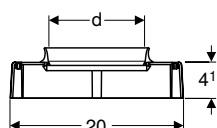

click & scan

Cod art.	DN	d, \varnothing [mm]	L [cm]	B [cm]	H [cm]	EUR/buc.
307.915.00.2	70	75	20	20	4,1	18,61
308.915.00.2	90	90	20	20	4,1	18,61
310.915.00.2	100	110	20	20	4,1	12,41



Geberit Silent-PP



Țevi	84
Fitinguri	86
Coturi	86
Ramificații	87
Reducții	90
Piese de curățire	92
Conexiuni	92
Îmbinări prin mufare	92
Racorduri gheară	93
Adaptoare la alte materiale	94
Racorduri de aparate	94
Coturi de conectare	94
Ștuțuri de conectare	96
Accesorii	96
Brățări pentru conducte	96
Dispozitive de închidere	97
Etanșări	98
Capac de protecție	99
Materiale consumabile	99

Tevi

Teavă Geberit Silent-PP cu mufă

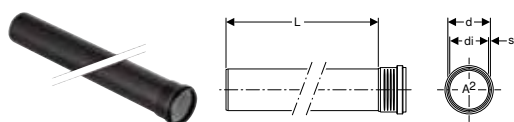

click & scan

Cod art.	DN	d, ø [mm]	di, ø [mm]	s [mm]	A ² [cm ²]	EUR/buc.
L / lungime: 15 cm						
390.000.14.1	30	32	28	2	6,2	2,07
390.100.14.1	40	40	36	2	10,2	2,07
390.200.14.1	50	50	46	2	16,6	2,22
390.300.14.1	70	75	69,8	2,6	38,3	4,27
390.400.14.1	90	90	83,8	3,1	55,2	4,41
390.500.14.1	100	110	102,8	3,6	83	5,09
390.600.14.1	125	125	116,6	4,2	106,8	7,28
390.700.14.1	150	160	149,6	5,2	175,8	11,00
L / lungime: 25 cm						
390.001.14.1	30	32	28	2	6,2	2,49
390.101.14.1	40	40	36	2	10,2	2,36
390.201.14.1	50	50	46	2	16,6	2,76
390.301.14.1	70	75	69,8	2,6	38,3	4,68
390.401.14.1	90	90	83,8	3,1	55,2	5,64
390.501.14.1	100	110	102,8	3,6	83	6,46
390.601.14.1	125	125	116,6	4,2	106,8	9,34
390.701.14.1	150	160	149,6	5,2	175,8	13,32
L / lungime: 50 cm						
390.002.14.1	30	32	28	2	6,2	3,30
390.102.14.1	40	40	36	2	10,2	3,44
390.202.14.1	50	50	46	2	16,6	3,44
390.302.14.1	70	75	69,8	2,6	38,3	6,59
390.402.14.1	90	90	83,8	3,1	55,2	8,65
390.502.14.1	100	110	102,8	3,6	83	9,89
390.602.14.1	125	125	116,6	4,2	106,8	13,59
390.702.14.1	150	160	149,6	5,2	175,8	20,44
L / lungime: 100 cm						
390.004.14.1	30	32	28	2	6,2	5,24
390.104.14.1	40	40	36	2	10,2	4,81
390.204.14.1	50	50	46	2	16,6	5,24
390.304.14.1	70	75	69,8	2,6	38,3	9,08
390.404.14.1	90	90	83,8	3,1	55,2	13,32
390.504.14.1	100	110	102,8	3,6	83	15,37
390.604.14.1	125	125	116,6	4,2	106,8	22,23
390.704.14.1	150	160	149,6	5,2	175,8	31,97
L / lungime: 150 cm						
390.005.14.1	30	32	28	2	6,2	8,25
390.105.14.1	40	40	36	2	10,2	8,52
390.205.14.1	50	50	46	2	16,6	8,65
390.305.14.1	70	75	69,8	2,6	38,3	13,05
390.405.14.1	90	90	83,8	3,1	55,2	18,80
390.505.14.1	100	110	102,8	3,6	83	21,28
390.605.14.1	125	125	116,6	4,2	106,8	29,22
390.705.14.1	150	160	149,6	5,2	175,8	44,03
L / lungime: 200 cm						
390.006.14.1	30	32	28	2	6,2	10,02
390.106.14.1	40	40	36	2	10,2	10,58
390.206.14.1	50	50	46	2	16,6	11,13
390.306.14.1	70	75	69,8	2,6	38,3	17,29
390.406.14.1	90	90	83,8	3,1	55,2	25,25
390.506.14.1	100	110	102,8	3,6	83	28,40
390.606.14.1	125	125	116,6	4,2	106,8	40,87
390.706.14.1	150	160	149,6	5,2	175,8	59,66
L / lungime: 300 cm						
390.007.14.1	30	32	28	2	6,2	13,85
390.107.14.1	40	40	36	2	10,2	14,83
390.207.14.1	50	50	46	2	16,6	17,29
390.307.14.1	70	75	69,8	2,6	38,3	25,52
390.407.14.1	90	90	83,8	3,1	55,2	36,21
390.507.14.1	100	110	102,8	3,6	83	40,61
390.607.14.1	125	125	116,6	4,2	106,8	57,18
390.707.14.1	150	160	149,6	5,2	175,8	84,88

Teavă Geberit Silent-PP cu două mufe

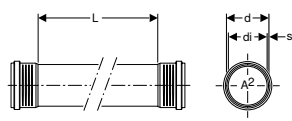
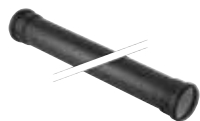

click & scan
EUR/buc.

Cod art.	DN	d, ø [mm]	di, ø [mm]	s [mm]	A ² [cm ²]	
L / lungime: 50 cm						
390.010.14.1	30	32	28	2	6,2	4,27
390.110.14.1	40	40	36	2	10,2	5,24
390.210.14.1	50	50	46	2	16,6	5,64
390.310.14.1	70	75	69,8	2,6	38,3	9,20
390.410.14.1	90	90	83,8	3,1	55,2	11,26
390.510.14.1	100	110	102,8	3,6	83	12,36
390.610.14.1	125	125	116,6	4,2	106,8	17,84
L / lungime: 100 cm						
390.011.14.1	30	32	28	2	6,2	6,59
390.111.14.1	40	40	36	2	10,2	6,74
390.211.14.1	50	50	46	2	16,6	6,87
390.311.14.1	70	75	69,8	2,6	38,3	11,26
390.411.14.1	90	90	83,8	3,1	55,2	15,66
390.511.14.1	100	110	102,8	3,6	83	18,53
390.611.14.1	125	125	116,6	4,2	106,8	29,08
L / lungime: 150 cm						
390.012.14.1	30	32	28	2	6,2	10,31
390.112.14.1	40	40	36	2	10,2	11,00
390.212.14.1	50	50	46	2	16,6	11,26
390.312.14.1	70	75	69,8	2,6	38,3	16,47
390.412.14.1	90	90	83,8	3,1	55,2	22,79
390.512.14.1	100	110	102,8	3,6	83	27,02
390.612.14.1	125	125	116,6	4,2	106,8	39,36
L / lungime: 200 cm						
390.013.14.1	30	32	28	2	6,2	12,61
390.113.14.1	40	40	36	2	10,2	12,61
390.213.14.1	50	50	46	2	16,6	13,59
390.313.14.1	70	75	69,8	2,6	38,3	20,58
390.413.14.1	90	90	83,8	3,1	55,2	28,82
390.513.14.1	100	110	102,8	3,6	83	34,57
390.613.14.1	125	125	116,6	4,2	106,8	53,63
L / lungime: 300 cm						
390.014.14.1	30	32	28	2	6,2	17,29
390.114.14.1	40	40	36	2	10,2	19,22
390.214.14.1	50	50	46	2	16,6	21,55
390.314.14.1	70	75	69,8	2,6	38,3	30,18
390.414.14.1	90	90	83,8	3,1	55,2	41,29
390.514.14.1	100	110	102,8	3,6	83	49,79
390.614.14.1	125	125	116,6	4,2	106,8	74,73



Fitinguri

Coturi

Cot Geberit Silent-PP

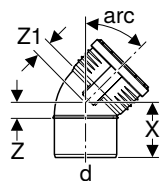

click & scan

Cod art.	DN	d, ø [mm]	X [cm]	Z [cm]	Z1 [cm]	EUR/buc.
arc / cot: 15°						
390.020.14.1	30	32	5	0,6	1	2,16
390.120.14.1	40	40	5,4	0,7	1,1	2,16
390.220.14.1	50	50	5,8	0,7	1,1	2,91
390.320.14.1	70	75	6,5	0,9	1,5	4,16
390.420.14.1	90	90	7,3	1,2	1,7	6,05
390.520.14.1	100	110	8,2	1,4	2	6,42
390.620.14.1	125	125	8,8	1,4	2,3	11,82
390.720.14.1	150	160	9,7	1,7	2,6	18,21
arc / cot: 30°						
390.021.14.1	30	32	5,2	0,8	0,9	2,16
390.121.14.1	40	40	5,7	0,9	1	2,16
390.221.14.1	50	50	6,2	1,1	1	2,65
390.321.14.1	70	75	7	1,5	1,5	4,16
390.421.14.1	90	90	7,9	1,8	1,7	6,05
390.521.14.1	100	110	9	2,1	2,2	6,42
390.621.14.1	125	125	9,8	2,4	2,5	11,82
390.721.14.1	150	160	11	3	2,8	18,21
arc / cot: 45°						
390.022.14.1	30	32	5,5	1	1,1	2,03
390.122.14.1	40	40	6	1,2	1,3	1,91
390.222.14.1	50	50	6,5	1,5	1,4	2,16
390.322.14.1	70	75	7,6	2	2,1	4,04
390.422.14.1	90	90	8,5	2,4	2,5	5,65
390.522.14.1	100	110	9,7	3	2,9	5,41
390.622.14.1	125	125	10,7	3,3	3,3	12,20
390.722.14.1	150	160	12,2	4,2	4	18,21
arc / cot: 67,5°						
390.023.14.1	30	32	5,9	1,5	1,5	2,52
390.123.14.1	40	40	6,5	1,8	1,8	2,52
390.223.14.1	50	50	7,2	2,1	2,1	3,28
390.323.14.1	70	75	8,6	3	3	5,80
390.423.14.1	90	90	9,7	3,6	3,5	6,29
390.523.14.1	100	110	11,2	4,4	4,3	7,05
390.623.14.1	125	125	12,3	4,9	4,9	17,20
390.723.14.1	150	160	14,3	6,2	6,1	28,50
arc / cot: 87,5°						
390.024.14.1	30	32	6,4	1,9	2	2,16
390.124.14.1	40	40	7,1	2,3	2,5	2,16
390.224.14.1	50	50	7,9	2,8	3	2,91
390.324.14.1	70	75	9,7	4,1	4,2	5,65
390.424.14.1	90	90	11	4,9	4,8	6,05
390.524.14.1	100	110	12,8	6	6	6,29
390.624.14.1	125	125	14,2	6,8	6,7	17,20
390.724.14.1	150	160	16,6	8,5	8,4	28,50

Ramificații

Ramificație 45° Geberit Silent-PP

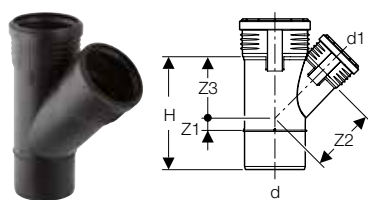

click & scan

Cod art.	DN	d, ø [mm]	d1, ø [mm]	arc [°]	H [cm]	Z1 [cm]	Z2 [cm]	Z3 [cm]	EUR/buc.
390.030.14.1	30 / 30	32	32	45	9,4	1	4	4	4,28
390.130.14.1	40 / 30	40	32	45	9,7	0,6	4,6	4,4	4,28
390.131.14.1	40 / 40	40	40	45	9,8	1,2	5	5	4,41
390.230.14.1	50 / 30	50	32	45	10	0,1	5,3	4,9	5,29
390.231.14.1	50 / 40	50	40	45	10,2	0,7	5,8	5,6	5,65
390.232.14.1	50 / 50	50	50	45	12,7	1	6,3	6,3	4,91
390.331.14.1	70 / 40	75	40	45	12	0,6	7,6	7	7,68
390.332.14.1	70 / 50	75	50	45	13,4	0,1	8,1	7,6	7,05
390.333.14.1	70 / 70	75	75	45	15	1,9	9,4	9,4	7,68
390.432.14.1	90 / 50	90	50	45	13	0,6	9,1	8,4	11,44
390.433.14.1	90 / 70	90	75	45	17,5	1,2	10,4	10,2	11,70
390.434.14.1	90 / 90	90	90	45	19,6	2,2	11,3	11,3	11,55
390.531.14.1	100 / 40	110	40	45	13,4	2,2	10,1	8,8	12,70
390.532.14.1	100 / 50	110	50	45	14,8	1,5	10,6	9,5	12,32
390.533.14.1	100 / 70	110	75	45	18,3	0,2	11,9	11,2	12,70
390.534.14.1	100 / 90	110	90	45	20,3	1,3	12,6	12,2	12,56
390.535.14.1	100 / 100	110	110	45	23,3	2,7	13,8	13,8	11,94
390.634.14.1	125 / 90	125	90	45	21	0,6	13,6	12,9	28,12
390.635.14.1	125 / 100	125	110	45	23,7	2,1	14,7	14,3	28,12
390.636.14.1	125 / 125	125	125	45	25,9	3,1	15,4	15,4	43,81
390.735.14.1	150 / 100	160	110	45	24,5	0,4	17,2	16,1	43,81
390.736.14.1	150 / 125	160	125	45	26,6	1,4	17,9	17,1	57,99
390.737.14.1	150 / 150	160	160	45	31,5	3,9	19,6	19,5	66,02

Ramificație 45° Geberit Silent-PP, dublă

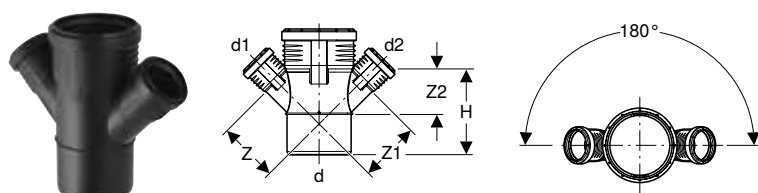

click & scan

Cod art.	DN	d, ø [mm]	d1, ø [mm]	d2, ø [mm]	arc [°]	H [cm]	Z [cm]	Z1 [cm]	Z2 [cm]	EUR/buc.
390.469.14.1	90 / 50 / 50	90	50	50	45	13,9	9,1	9,1	8,4	21,48
390.569.14.1	100 / 50 / 50	110	50	50	45	14,8	10,6	10,6	9,5	20,98

Ramificație cot 87,5° Geberit Silent-PP

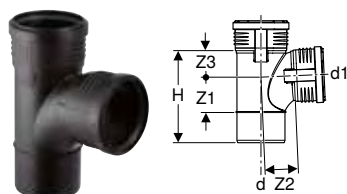

click & scan

Cod art.	DN	d, ø [mm]	d1, ø [mm]	arc [°]	H [cm]	Z1 [cm]	Z2 [cm]	Z3 [cm]	EUR/buc.
390.454.14.1	90 / 90	90	90	87,5	17,7	6,7	7	4,9	12,20
390.554.14.1	100 / 90	110	90	87,5	18,6	6,8	8,1	5	12,32
390.555.14.1	100 / 100	110	110	87,5	21,2	8,2	7,7	6,1	12,32

Ramificație 87,5° Geberit Silent-PP

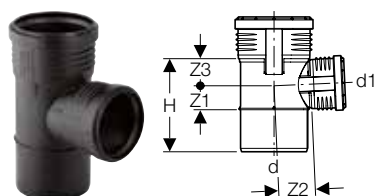

click & scan

Cod art.	DN	d, ø [mm]	d1, ø [mm]	arc [°]	H [cm]	Z1 [cm]	Z2 [cm]	Z3 [cm]	EUR/buc.
390.046.14.1	30/30	32	32	87,5	8,2	1,7	2,1	2,1	4,28
390.147.14.1	40/40	40	40	87,5	9,2	2,2	2,2	2,2	4,41
390.247.14.1	50/40	50	40	87,5	9,5	2,2	2,8	2,2	5,65
390.248.14.1	50/50	50	50	87,5	10,5	2,7	2,8	2,8	5,65
390.347.14.1	70/40	75	40	87,5	10,4	2,3	4,2	2,6	7,68
390.348.14.1	70/50	75	50	87,5	11,4	2,8	4,2	3,1	7,68
390.349.14.1	70/70	75	75	87,5	13,9	4	4,3	4,3	7,68
390.448.14.1	90/50	90	50	87,5	12,1	2,8	4,9	3,2	11,55
390.449.14.1	90/70	90	75	87,5	14,6	4	5,1	4,5	11,70
390.547.14.1	100/40	110	40	87,5	12,4	2,7	6	2,9	12,56
390.548.14.1	100/50	110	50	87,5	12,9	2,8	6	3,2	12,56
390.549.14.1	100/70	110	75	87,5	15,4	4	6,1	4,5	12,70
390.650.14.1	125/90	125	90	87,5	17,1	4,6	6,9	5,2	28,12
390.651.14.1	125/100	125	110	87,5	21,3	6,6	7,8	7,3	28,12
390.652.14.1	125/125	125	125	87,5	20,6	6,4	6,8	6,8	42,44
390.751.14.1	150/100	160	110	87,5	19,8	5,5	8,8	6,2	43,81
390.752.14.1	150/125	160	125	87,5	21,3	6,4	8,7	6,9	57,99
390.753.14.1	150/150	160	160	87,5	24,8	8,2	8,6	8,6	66,02

Ramificație cot 87,5° Geberit Silent-PP, dublă

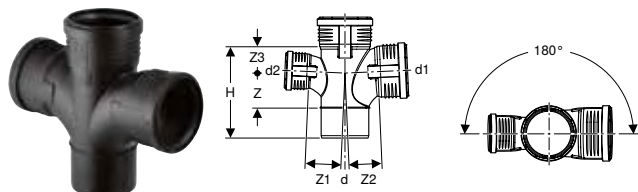

click & scan

Cod art.	DN	d, ø [mm]	d1, ø [mm]	d2, ø [mm]	arc [°]	H [cm]	Z [cm]	Z1 [cm]	Z2 [cm]	Z3 [cm]	EUR/buc.
390.466.14.1	90/90/90	90	90	90	87,5	17,7	6,7	7	7	4,9	55,36
390.567.14.1	100/100/70	110	110	75	87,5	21,2	8,2	8,3	7,7	6,1	53,34
390.566.14.1	100/100/100	110	110	110	87,5	21,2	8,2	7,7	7,7	6,1	53,34

Ramificație Geberit Silent-PP 87.5° din două elemente

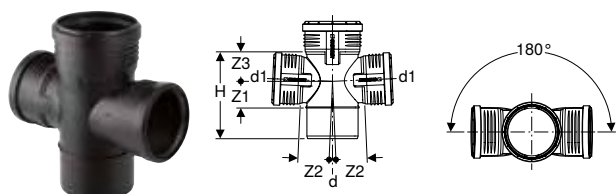

click & scan

Cod art.	DN	d, ø [mm]	d1, ø [mm]	arc [°]	H [cm]	Z1 [cm]	Z2 [cm]	Z3 [cm]	EUR/buc.
390.665.14.1	125/100/100	125	110	87,5	21,3	6,6	7,8	7,3	38,05

Ramificație colț 87,5° Geberit Silent-PP

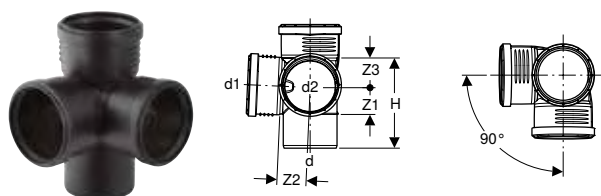

click & scan

Cod art.	DN	d, ø [mm]	d1, ø [mm]	d2, ø [mm]	arc [°]	H [cm]	Z1 [cm]	Z2 [cm]	Z3 [cm]	EUR/buc.
390.459.14.1	90 / 90 / 90	90	90	90	87,5	15,7	4,6	5	5	49,83
390.559.14.1	100 / 100 / 100	110	110	110	87,5	18,6	5,6	6	6,1	55,61
390.662.14.1	125 / 100 / 100	125	110	110	87,5	21,3	6,6	7,8	7,3	60,24

Ramificație cot combi 87,5° Geberit Silent-PP

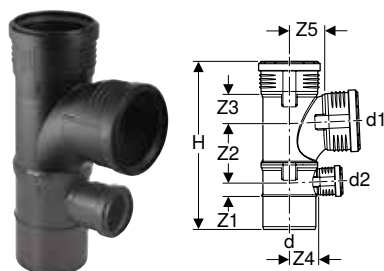

click & scan

Cod art.	DN	d, ø [mm]	d1, ø [mm]	d2, ø [mm]	arc [°]	H [cm]	Z1 [cm]	Z2 [cm]	Z3 [cm]	Z4 [cm]	Z5 [cm]	EUR/buc.
390.456.14.1	90 / 90 / 50	90	90	50	87,5	30,6	2,8	10,7	4,9	4,9	7	53,09
390.556.14.1	100 / 90 / 50	110	90	50	87,5	32,4	2,8	10,9	5	6	8,1	56,35
390.558.14.1	100 / 100 / 50	110	110	50	87,5	35	2,8	12,4	6,1	6	7,7	56,35

Ramificație cot colț combi 87,5° Geberit Silent-PP, stânga

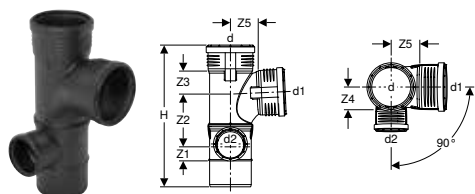

click & scan

Cod art.	DN	d, ø [mm]	d1, ø [mm]	d2, ø [mm]	arc [°]	H [cm]	Z1 [cm]	Z2 [cm]	Z3 [cm]	Z4 [cm]	Z5 [cm]	EUR/buc.
390.470.14.1	90 / 90 / 50	90	90	50	87,5	30,6	3,2	10,9	5,2	4,9	6,7	53,09
390.570.14.1	100 / 90 / 50	110	90	50	87,5	32,4	3,3	11,1	5,4	5,9	7,8	55,48
390.578.14.1	100 / 100 / 50	110	110	50	87,5	35	3,3	12,6	6,5	5,9	7,4	55,48
390.561.14.1	100 / 100 / 70	110	110	75	87,5	37,5	4,2	13,8	6,5	6	7,8	55,48

Ramificație cot colț combi 87,5° Geberit Silent-PP, dreapta

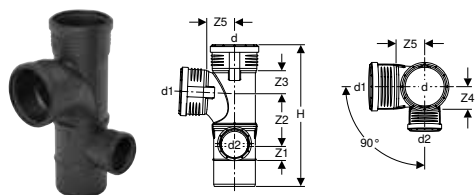

click & scan

Cod art.	DN	d, ø [mm]	d1, ø [mm]	d2, ø [mm]	arc [°]	H [cm]	Z1 [cm]	Z2 [cm]	Z3 [cm]	Z4 [cm]	Z5 [cm]	EUR/buc.
390.462.14.1	90 / 90 / 50	90	90	50	87,5	30,6	3,2	10,9	5,2	4,9	6,7	53,09
390.562.14.1	100 / 90 / 50	110	90	50	87,5	32,4	3,3	11,1	5,4	5,9	7,8	55,48
390.565.14.1	100 / 100 / 50	110	110	50	87,5	35	3,3	12,6	6,5	5,9	7,4	55,48
390.560.14.1	100 / 100 / 70	110	110	75	87,5	37,5	4,2	13,8	6,5	6	7,8	55,48

Cot de ramificație cămin 87,5° Geberit Silent-PP, stânga

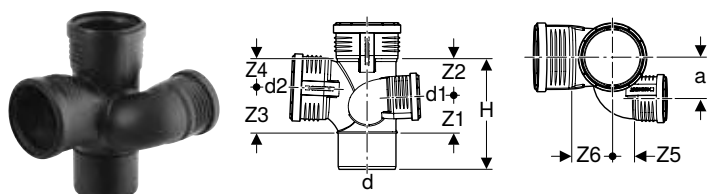

click & scan

Cod art.	DN	d, ø [mm]	d1, ø [mm]	d2, ø [mm]	arc [°]	a [cm]	H [cm]	Z1 [cm]	Z2 [cm]	Z3 [cm]	Z4 [cm]	Z5 [cm]	Z6 [cm]	EUR/buc.
390.464.14.1	90 / 70 / 90	90	75	90	87,5	8,2	17,6	6,3	5,3	6,7	4,9	3,5	6,9	91,73
390.564.14.1	100 / 70 / 100	110	75	110	87,5	9,2	21,1	6,7	7,6	8,2	6,1	4,4	7,7	101,52

Cot de ramificație cămin 87,5° Geberit Silent-PP, dreapta

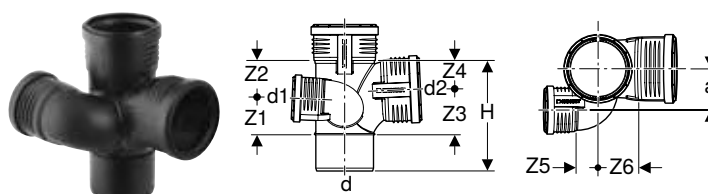

click & scan

Cod art.	DN	d, ø [mm]	d1, ø [mm]	d2, ø [mm]	arc [°]	a [cm]	H [cm]	Z1 [cm]	Z2 [cm]	Z3 [cm]	Z4 [cm]	Z5 [cm]	Z6 [cm]	EUR/buc.
390.463.14.1	90 / 70 / 90	90	75	90	87,5	8,2	17,6	6,3	5,3	6,7	4,9	3,5	6,9	91,73
390.563.14.1	100 / 70 / 100	110	75	110	87,5	9,2	21,1	6,7	7,6	8,2	6,1	4,4	7,7	101,52

Ramificație paralelă 45° Geberit Silent-PP

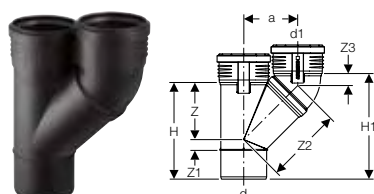

click & scan

Cod art.	DN	d, ø [mm]	d1, ø [mm]	arc [°]	a [cm]	H [cm]	H1 [cm]	Z [cm]	Z1 [cm]	Z2 [cm]	Z3 [cm]	EUR/buc.
390.457.14.1	90 / 90	90	90	45	11	19,6	21,4	11,3	2,2	15	2,5	47,96
390.557.14.1	100 / 100	110	110	45	13	23,3	25,5	13,8	2,7	18,4	2,9	47,08

Reducții

Reducție excentrică Geberit Silent-PP, scurtă

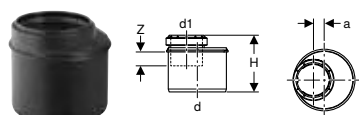

click & scan

Cod art.	DN	d, ø [mm]	d1, ø [mm]	a [cm]	H [cm]	Z [cm]	EUR/buc.
390.373.14.1	70 / 50	75	50	1	8,4	2,3	4,04
390.474.14.1	90 / 50	90	50	1,7	8,8	2,4	5,65
390.475.14.1	90 / 70	90	75	0,4	8,9	2,8	5,65
390.575.14.1	100 / 50	110	50	2,6	9,5	2,4	5,54
390.576.14.1	100 / 70	110	75	1,4	9,6	2,9	5,92
390.577.14.1	100 / 90	110	90	0,6	9,8	3,2	6,42

Reducție excentrică Geberit Silent-PP

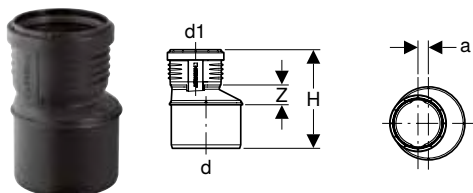

click & scan

Cod art.	DN	d, ø [mm]	d1, ø [mm]	a [cm]	H [cm]	Z [cm]	EUR/buc.
390.271.14.1	50 / 40	50	40	0,5	11,4	1,6	3,17
390.279.14.1	50 / 30	50	32	0,9	11,3	1,9	3,28
390.372.14.1	70 / 50	75	50	1,2	13,3	2,6	4,04
390.471.14.1	90 / 40	90	40	2,4	14,6	3,8	5,65
390.472.14.1	90 / 50	90	50	1,9	14,6	3,4	5,65
390.473.14.1	90 / 70	90	75	0,7	13,9	2,2	5,65
390.571.14.1	100 / 40	110	40	3,3	16,4	4,9	5,92
390.572.14.1	100 / 50	110	50	2,8	16,4	4,5	5,80
390.573.14.1	100 / 70	110	75	1,7	15,7	3,3	6,05
390.574.14.1	100 / 90	110	90	1	15,7	2,7	6,42
390.675.14.1	125 / 100	125	110	0,7	17,1	2,9	10,81
390.775.14.1	150 / 100	160	110	2,3	19,4	4,5	16,26
390.776.14.1	150 / 125	160	125	1,7	19,4	4	16,26

Reducție centrică Geberit Silent-PP, scurtă

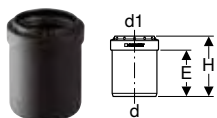

click & scan
EUR/buc.

Cod art.	DN	d, ø [mm]	d1, ø [mm]	E [cm]	H [cm]	EUR/buc.
390.179.14.1	40 / 30	40	32	5	6,8	3,28
390.278.14.1	50 / 40	50	40	5,2	6,8	3,17

Cot de reducere 87,5° Geberit Silent-PP

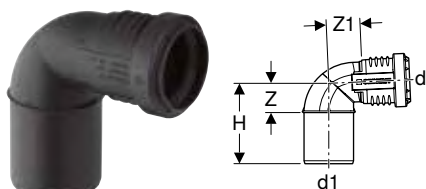

click & scan

Cod art.	DN	d, ø [mm]	d1, ø [mm]	arc [°]	H [cm]	Z [cm]	Z1 [cm]	EUR/buc.
390.225.14.1	40 / 50	40	50	87,5	8,1	3,1	3,5	2,91
390.325.14.1	50 / 70	50	75	87,5	9,8	5,1	3,8	6,67



- Cod art. nr. 390.325.14.1 este un fitting sudat

Piese de curățire

Piesă de curățare 90° Geberit Silent-PP cu orificiu de service rotund

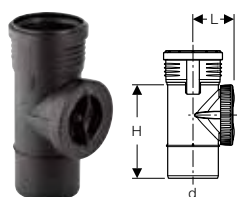

click & scan

Cod art.	DN	d, ø [mm]	arc [°]	L [cm]	H [cm]	EUR/buc.
390.227.14.1	50	50	90	4,7	12,3	10,05
390.327.14.1	70	75	90	6,1	15,4	12,20
390.427.14.1	90	90	90	7,4	17,7	16,71
390.527.14.1	100	110	90	9	21	18,09
390.627.14.1	125	125	90	9,8	21,5	34,89
390.727.14.1	150	160	90	11,6	22,2	53,46

Piesă de curățare 90° Geberit Silent-PP cu orificiu de service oval

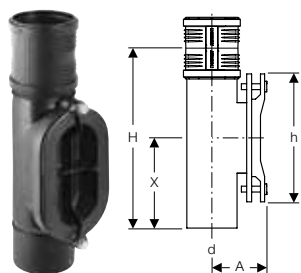

click & scan

Cod art.	DN	d, ø [mm]	arc [°]	A [cm]	H [cm]	h [cm]	X [cm]	EUR/buc.
390.503.14.1	100	110	90	12	40,3	28	20	170,41
390.603.14.1	125	125	90	12,5	41,4	28	20,5	213,06
390.703.14.1	150	160	90	14	43,4	28	21,5	241,42

Conexiuni

Îmbinări prin mufare

Mufă de dilatație Geberit Silent-PP

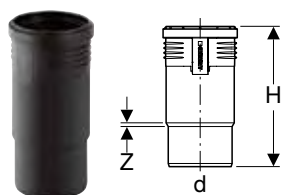

click & scan

Cod art.	DN	d, ø [mm]	H [cm]	Z [cm]	EUR/buc.
390.118.14.1	40	40	16,8	0,1	3,42
390.218.14.1	50	50	18,1	0,3	4,28
390.318.14.1	70	75	19,8	0,6	6,29
390.418.14.1	90	90	21,7	0,3	9,30
390.518.14.1	100	110	24,2	0,5	10,05
390.618.14.1	125	125	26,5	0,6	13,19
390.718.14.1	150	160	29	0,6	24,23

Mufă de cuplare dublă Geberit Silent-PP

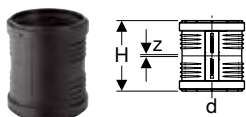
[click & scan](#)
EUR/buc.

Cod art.	DN	d, ø [mm]	H [cm]	Z [cm]	
390.016.14.1	30	32	9	0,1	3,78
390.116.14.1	40	40	9,6	0,1	3,78
390.216.14.1	50	50	10,3	0,1	3,91
390.316.14.1	70	75	11,3	0,2	5,29
390.416.14.1	90	90	12,4	0,2	8,43
390.516.14.1	100	110	13,9	0,3	9,30
390.616.14.1	125	125	15,2	0,4	19,98
390.716.14.1	150	160	16,5	0,4	19,98

Manșon alunecător Geberit Silent-PP

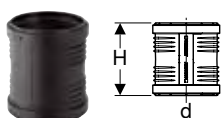
[click & scan](#)
EUR/buc.

Cod art.	DN	d, ø [mm]	H [cm]	
390.017.14.1	30	32	9	3,78
390.117.14.1	40	40	9,6	3,78
390.217.14.1	50	50	10,3	3,91
390.317.14.1	70	75	11,3	5,29
390.417.14.1	90	90	12,4	8,43
390.517.14.1	100	110	13,9	9,30
390.617.14.1	125	125	15,2	16,58
390.717.14.1	150	160	16,5	24,74

Racorduri gheară

Gheară de susținere Geberit

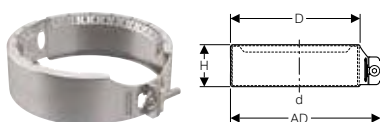
[click & scan](#)
EUR/buc.

Cod art.	DN	d, ø [mm]	AD [cm]	D [cm]	H [cm]	
390.008.14.1	30	32	5,7	4,5	3,3	4,28
390.108.14.1	40	40	6,9	5,7	3,5	5,16
390.203.14.1	50	50	8,2	7	3,8	5,92
390.308.14.1	70	75	10,9	9,6	3,7	7,05
390.408.14.1	90	90	12,6	11,3	4,1	7,92
390.508.14.1	100	110	14,7	13,5	4,1	12,56
390.608.14.1	125	125	16,5	15,2	4,5	16,46
390.708.14.1	150	160	20,6	19,3	5	21,98

Adaptoare la alte materiale

Mufă de trecere Geberit pe fontă

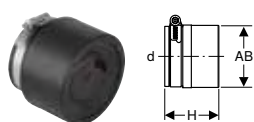

click & scan
 EUR/buc.

Cod art.	DN	d, \emptyset [mm]	AB [mm]	H [cm]	
390.295.14.1	40 / 50	58	40-56	6,3	4,16
390.395.14.1	56 / 70	78	56-75	7,7	5,92
390.495.14.1	70 / 80 / 90	83	75-90	7,7	6,91
390.595.14.1	100	110	104-110	9,5	10,94
390.695.14.1	125	135	125	10,3	16,34

Mufă adaptor Geberit din fontă



click & scan

Cod art.	DN	d, \emptyset [mm]	d1, \emptyset [mm]	EUR/buc.
367.009.16.1	90 / 100	90	110	22,36

Mufă de adaptare Geberit pentru Geberit Silent-db20

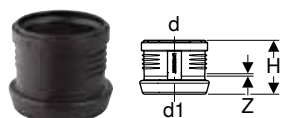

click & scan
 EUR/buc.

Cod art.	DN	d, \emptyset [mm]	d1, \emptyset [mm]	H [cm]	Z [cm]	
390.296.14.1	50 / 56	50	56	8,7	0,3	6,05
390.396.14.1	70 / 70	75	75	9,2	0,3	9,06
390.496.14.1	90 / 90	90	90	9,7	0,3	9,93
390.596.14.1	100 / 100	110	110	10,4	0,3	10,19
390.696.14.1	125 / 125	125	135	12	0,3	27,49
390.796.14.1	150 / 150	160	160	13,6	0,4	60,12

Racorduri de aparate

Coturi de conectare

Cot de conectare 90° Geberit Silent-PP

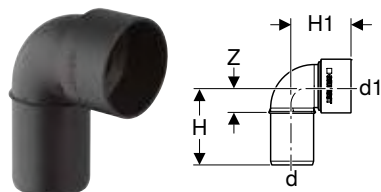

click & scan

Cod art.	DN	d, \emptyset [mm]	d1, \emptyset [mm]	arc [°]	H [cm]	H1 [cm]	Z [cm]	EUR/buc.
390.083.14.1	30	32	46	90	7,1	5,1	2,6	5,41
390.183.14.1	40	40	46	90	7,4	5,5	2,6	3,66
390.283.14.1	50	50	46	90	8,2	5,7	3,2	3,66
390.284.14.1	50	50	58	90	8,3	5,9	3,2	3,66

De comandat suplimentar

- Manșetă

Accesorii

- Mufă Geberit → p. 39
- Mufă Geberit → p. 39

Cot de conectare 90° Geberit Silent-PP, lung

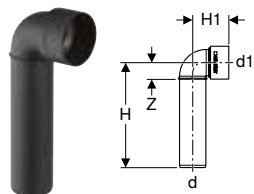

click & scan

Cod art.	DN	d, ø [mm]	d1, ø [mm]	arc [°]	H [cm]	H1 [cm]	Z [cm]	EUR/buc.
390.186.14.1	40	40	46	90	16	5,5	11,3	3,91

De comandat suplimentar

- Manșetă

Accesorii

- Mufă Geberit → p. 39

Cot de conectare 90° Geberit Silent-PP, prelungit

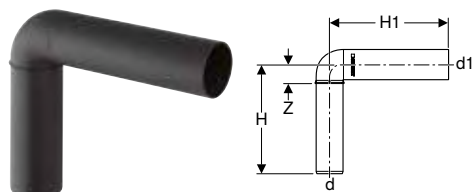

click & scan

Cod art.	DN	d, ø [mm]	d1, ø [mm]	arc [°]	H [cm]	H1 [cm]	Z [cm]	EUR/buc.
390.286.14.1	50	50	46	90	16	20	10,9	3,91
390.287.14.1	50	50	58	90	16	20	10,9	3,91

Accesorii

- Mufă Geberit → p. 39
- Mufă Geberit → p. 39

Cot de conectare dublu 90° Geberit Silent-PP, prelungit

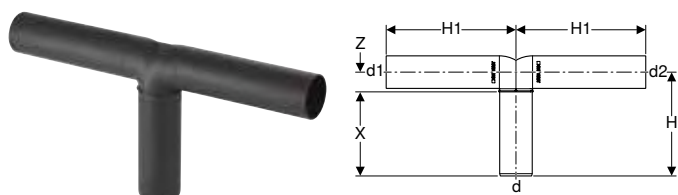

click & scan

Cod art.	DN	d, ø [mm]	d1, ø [mm]	d2, ø [mm]	arc [°]	H [cm]	H1 [cm]	X [cm]	Z [cm]	EUR/buc.
390.289.14.1	50 / 40 / 40	50	46	46	90	16	20	10,9	5,1	6,05

Accesorii

- Mufă Geberit → p. 39
- Mufă Geberit → p. 39

Cot de conectare 87,5° Geberit Silent-PP, pentru WC

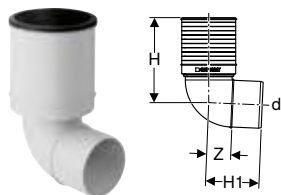

click & scan

Cod art.	Culoare/suprafață	DN	d, ø [mm]	arc [°]	H [cm]	H1 [cm]	Z [cm]	EUR/buc.
390.493.11.1	Alb alpin	90	90	87,5	20	12,6	5,8	21,98
390.593.11.1	Alb alpin	100	110	87,5	19,1	11	4,9	23,73

Ștuțuri de conectare

Ștuț de conectare Geberit Silent-PP



click & scan

Cod art.	DN	d, ø [mm]	d1, ø [mm]	E [cm]	H [cm]	EUR/buc.
390.080.14.1	30	32	46	4,5	3,5	5,41
390.180.14.1	40	40	46	4,7	3,2	3,66
390.281.14.1	50	50	58	5,1	3,2	3,66

De comandat suplimentar

- Manșetă

Accesorii

- Mufă Geberit → p. 39

Set ștuțuri de racordare Geberit Silent-PP pentru WC

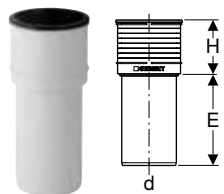

click & scan

Cod art.	Culoare/suprafață	DN	d, ø [mm]	E [cm]	H [cm]	EUR/buc.
390.592.11.1	Alb alpin	100	110	18	10,9	22,36

Accesorii

Brățări pentru conducte

Colier de țevă Geberit Silent-PP, izolat, cu piuliță conector M8 / M10

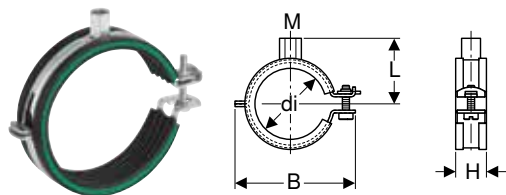

click & scan

Cod art.	Culoare/suprafață	DN	M [mm]	di, ø [mm]	L [cm]	B [cm]	H [cm]	EUR/buc.
390.099.26.1	Galvanizat	30	8 / 10	32	4	7,1	2,3	1,91
390.199.26.1	Galvanizat	40	8 / 10	40	4,2	7,7	2,3	2,04
390.299.26.1	Galvanizat	50	8 / 10	50	4,8	8,8	2,3	1,91

Cod art.	Culoare/suprafață	DN	M [mm]	di, ø [mm]	L [cm]	B [cm]	H [cm]	EUR/buc.
390.399.26.1	Galvanizat	70	8 / 10	75	6,2	12,6	2,8	3,69
390.499.26.1	Galvanizat	90	8 / 10	90	6,8	13,7	2,8	3,69
390.599.26.1	Galvanizat	100	8 / 10	110	7,7	15,6	2,8	3,81
390.699.26.1	Galvanizat	125	8 / 10	125	8,9	17,4	2,8	5,93
390.799.26.1	Galvanizat	150	8 / 10	160	10,6	21,2	2,8	7,46

Brățară de alunecare Geberit Silent-PP, izolată, cu piuliță conector M8 / M10

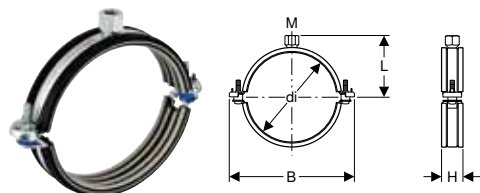

click & scan



Cod art.	Culoare/suprafață	DN	M [mm]	di, ø [mm]	L [cm]	B [cm]	H [cm]	EUR/buc.
390.098.26.1	S Galvanizat	30	8 / 10	32	4,1	8,7	3	3,29
390.198.26.1	S Galvanizat	40	8 / 10	40	4,5	9,5	3	3,69
390.298.26.1	S Galvanizat	50	8 / 10	50	5	10,5	3	3,93
390.398.26.1	S Galvanizat	70	8 / 10	75	6,3	13	3	6,20
390.498.26.1	S Galvanizat	90	8 / 10	90	7	14,5	3	7,08
390.598.26.1	S Galvanizat	100	8 / 10	110	8	16,5	3	8,35

S: Sfârșit de producție



• Înlocuiește cod art. 390.099.26.1, 390.199.26.1, 390.299.26.1, 390.399.26.1, 390.499.26.1, 390.599.26.1

Dispozitive de închidere

Dop de mufă Geberit Silent-PP



click & scan

Cod art.	DN	d, ø [mm]	H [cm]	EUR/buc.
390.128.14.1	40	40	4,1	2,52
390.228.14.1	50	50	4,7	3,17
390.328.14.1	70	75	5,4	4,04
390.428.14.1	90	90	6	8,69
390.528.14.1	100	110	6,6	9,18
390.628.14.1	125	125	7,3	12,07
390.728.14.1	150	160	7,9	14,95

Etanșări

Garnitură de etanșare cu manșetă Geberit EPDM



click & scan
EUR/buc.

Cod art.	DN	d, ø [mm]	
242.278.00.1	30	32	1,29
241.785.00.1	40	40	1,29
241.786.00.1	50	50	1,29
241.787.00.1	70	75	1,84
241.790.00.1	90	90	1,84
241.791.00.1	100	110	1,84
242.279.00.1	125	125	1,84
242.280.00.1	150	160	1,84

Garnitură de etanșare cu manșetă Geberit EPDM, simetrică



click & scan
EUR/buc.

Cod art.	DN	d, ø [mm]	
242.281.00.1	30	32	1,29
241.792.00.1	40	40	1,29
241.793.00.1	50	50	1,29
241.794.00.1	70	75	1,29
241.795.00.1	90	90	1,29
241.796.00.1	100	110	1,29
242.282.00.1	125	125	1,29
242.283.00.1	150	160	1,29

Mufă Geberit

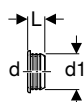

click & scan
EUR/buc.

Cod art.	d, ø [mm]	d1, ø [mm]	L [cm]	
152.498.00.1	32	40	2,5	2,17
152.796.00.1	40	44	2,3	2,18
152.495.00.1	32	46	2,3	2,17
152.496.00.1	40	46	2,3	1,95
153.564.16.1	32	58	2,3	3,68
153.565.16.1	40	58	2,3	3,43
153.566.16.1	50	58	2,3	3,43

Mufă Geberit

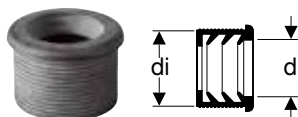
[click & scan](#)

Cod art.	DN	d, ø [mm]	di, ø [mm]	EUR/buc.
152.682.00.1	50	32	44	2,18
152.689.00.1	56	32	50	3,43
152.690.00.1	56	40	50	3,08
152.691.00.1	60	32	57	5,56
152.692.00.1	60	40	57	4,81
152.693.00.1	60	50	57	4,32

Capac de protecție

Capac de protecție Geberit Silent-PP

[click & scan](#)

Cod art.	d, ø [mm]	EUR/buc.
241.799.00.1	46	1,79
241.885.00.1	58	3,57

Capac de protecție Geberit Silent-PP

[click & scan](#)

Cod art.	d, ø [mm]	EUR/buc.
241.798.00.1	110	3,57

Materiale consumabile

Lubrifiant Geberit, 250 ml

[click & scan](#)

Cod art.	EUR/buc.
953.761.00.1	4,92

Creion de gresare Geberit cu mină retractabilă

[click & scan](#)

Cod art.	Culoare/suprafață	EUR/buc.
690.102.00.1	Galben	6,97



Geberit Silent-Pro

Fitinguri SuperTube	102
Coturi	102
Ramificații.....	102
Conexiuni.....	103
Racorduri gheară.....	103
Adaptoare la alte materiale	103
Accesorii.....	104
Dispozitive de închidere	104
Etanșări	104
Material de consum	105



Fitinguri SuperTube

Coturi

Nou

Cot Geberit Silent-Pro BottomTurn

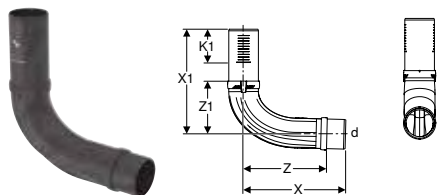

click & scan

Cod art.	DN	d, ø [mm]	arc [°]	X [cm]	X1 [cm]	Z [cm]	Z1 [cm]	K1 max. [cm]	EUR/buc.
393.525.14.1	100	110	90	37,9	39,1	31,1	18,9	12,4	179,46

Livrabil din April 2024

Nou

Cot Geberit Silent-Pro BackFlip

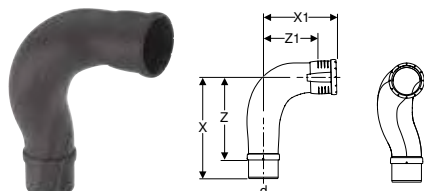

click & scan

Cod art.	DN	d, ø [mm]	arc [°]	X [cm]	X1 [cm]	Z [cm]	Z1 [cm]	EUR/buc.
393.526.14.1	100	110	90	37,8	28,2	30,3	20,4	82,63

Livrabil din April 2024

Ramificații

Nou

Ramificație Geberit Silent-Pro Carve 87,5°

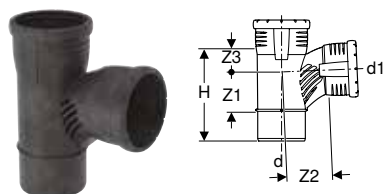

click & scan

Cod art.	DN	d, ø [mm]	d1, ø [mm]	arc [°]	H [cm]	Z1 [cm]	Z2 [cm]	Z3 [cm]	EUR/buc.
393.544.14.1	100 / 50	110	50	87,5	12,9	4,7	8,9	1,4	34,45
393.545.14.1	100 / 70	110	75	87,5	15,2	5,2	8,9	3,2	34,45
393.541.14.1	100 / 90	110	90	87,5	18,3	7,3	10,4	4,2	34,45
393.540.14.1	100 / 100	110	110	87,5	21,2	9,2	10,7	5,2	34,45

Livrabil din April 2024

Conexiuni

Racorduri gheară

Gheară de susținere Geberit

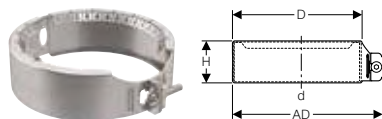

click & scan
EUR/buc.

Cod art.	DN	d, ø [mm]	AD [cm]	D [cm]	H [cm]	
390.203.14.1	50	50	8,2	7	3,8	5,92
390.308.14.1	70	75	10,9	9,6	3,7	7,05
390.408.14.1	90	90	12,6	11,3	4,1	7,92
390.508.14.1	100	110	14,7	13,5	4,1	12,56
390.608.14.1	125	125	16,5	15,2	4,5	16,46
390.708.14.1	150	160	20,6	19,3	5	21,98

Adaptoare la alte materiale

Element de prindere cu reducție Geberit

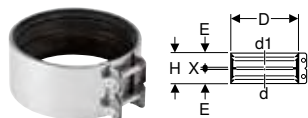

click & scan
EUR/buc.

Cod art.	DN	d, ø [mm]	d1, ø [mm]	D [cm]	E [cm]	H [cm]	X [cm]	
359.465.00.2	50	50	58	7,5	2,7	5,7	0,3	13,08
359.434.00.2	70	75-76	78	9,3	2,7	5,7	0,3	16,78
359.435.00.2	70	75-76	83-84	9,8	2,7	5,7	0,3	16,78
359.437.00.2	90	89-90	83-84	11,1	2,7	5,7	0,3	14,40
359.441.00.2	100	108-110	108-110	12,5	2,7	5,7	0,3	15,59
359.444.00.2	125	125	131-135	15	3,3	6,9	0,3	24,81
359.449.00.2	150	159-160	159-160	17,5	3,3	6,9	0,3	42,28

Mufă de adaptare Geberit pentru Geberit Silent-db20

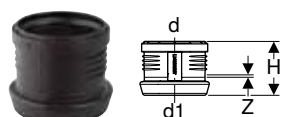

click & scan
EUR/buc.

Cod art.	DN	d, ø [mm]	d1, ø [mm]	H [cm]	Z [cm]	
390.296.14.1	50 / 56	50	56	8,7	0,3	6,05
390.396.14.1	70 / 70	75	75	9,2	0,3	9,06
390.496.14.1	90 / 90	90	90	9,7	0,3	9,93
390.596.14.1	100 / 100	110	110	10,4	0,3	10,19
390.696.14.1	125 / 125	125	135	12	0,3	27,49
390.796.14.1	150 / 150	160	160	13,6	0,4	60,12

Accesorii

Dispozitive de închidere

Dop de mufă Geberit Silent-PP



click & scan
EUR/buc.

Cod art.	DN	d, ø [mm]	H [cm]	
390.228.14.1	50	50	4,7	3,17
390.328.14.1	70	75	5,4	4,04
390.428.14.1	90	90	6	8,69
390.528.14.1	100	110	6,6	9,18
390.628.14.1	125	125	7,3	12,07
390.728.14.1	150	160	7,9	14,95

Etanșări

Garnitură de etanșare cu manșetă Geberit EPDM



click & scan
EUR/buc.

Cod art.	DN	d, ø [mm]	
241.786.00.1	50	50	1,29
241.787.00.1	70	75	1,84
241.790.00.1	90	90	1,84
241.791.00.1	100	110	1,84
242.279.00.1	125	125	1,84
242.280.00.1	150	160	1,84

Garnitură de etanșare cu manșetă Geberit EPDM, simetrică



click & scan
EUR/buc.

Cod art.	DN	d, ø [mm]	
241.793.00.1	50	50	1,29
241.794.00.1	70	75	1,29
241.795.00.1	90	90	1,29
241.796.00.1	100	110	1,29
242.282.00.1	125	125	1,29
242.283.00.1	150	160	1,29

Material de consum

Lubrifiant Geberit, 250 ml



click & scan
EUR/buc.

Cod art.			
953.761.00.1			4,92

Creion de gresare Geberit cu mină retractabilă



click & scan
EUR/buc.

Cod art.	Culoare/suprafață		
690.102.00.1	Galben		6,97





GEBERIT
GFB 90
BON-AIR
TYPE-A1-EN 12082

Bechtungsgefahr!
Nur für Abwasser / Toiletten
Nur Abwasser verwenden!

Ventile de aerisire pentru drenaj

Ventile de aerisire 108



Ventile de aerisire

Ventil de aerisire Geberit GRB50, pentru sisteme de drenare



click & scan

Cod art.	Culoare/suprafață	DN	d, ø [mm]	G [„]	d1, ø [mm]	di, ø [mm]	L [cm]	B [cm]	H [cm]	h [cm]	EUR/buc.
359.900.00.1	Alb	50	50	1 1/2"	63	32 / 40	8,3	7,4	7,3	3,2	42,30

Ventil de aerisire GRB90, pentru Geberit HDPE

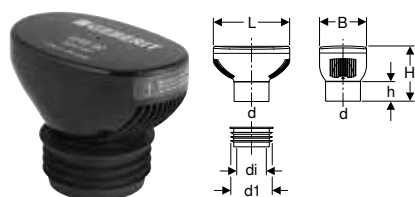

click & scan

Cod art.	Culoare/suprafață	DN	d, ø [mm]	d1, ø [mm]	di, ø [mm]	L [cm]	B [cm]	H [cm]	h [cm]	EUR/buc.
310.006.00.1	Negru	90	90	103,5	75	19,5	12	14,1	5	64,08

Ventil de aerisire GRB90, pentru Geberit Silent-db20

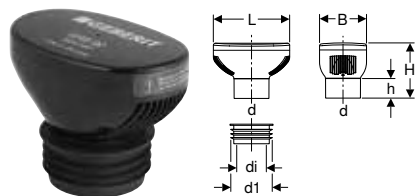

click & scan

Cod art.	Culoare/suprafață	DN	d, ø [mm]	d1, ø [mm]	di, ø [mm]	L [cm]	B [cm]	H [cm]	h [cm]	EUR/buc.
310.007.00.1	Negru	90	90	99,5	75	19,5	12	14,1	5	64,08





Protecție antifoc, izolare acustică și protecție contra umezelii

Protecție antifoc	112
Protecție antifoc pentru sisteme de drenare	112
Izolare acustică.....	112
Izolații contra propagării sunetului în masă solidă	112
Izolații contra propagării sunetului în masă solidă și contra propagării sunetului în aer	113
Protecție contra umezelii	114
Etanșări	114



Protecție antifoc

Protecție antifoc pentru sisteme de drenare

Manșetă antiincendiu RS90 Plus EN Geberit

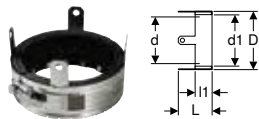

click & scan
EUR/buc.

Cod art.	DN	d, ø [mm]	d1, ø [mm]	D [cm]	L [cm]	l1 [cm]	EUR/buc.
348.300.00.1	40-56	40-56	63	7,8	8,5	5	44,79
348.301.00.1	60 / 70	63 / 75	83	10,2	8,5	5	48,04
348.302.00.1	90	90	98	11,9	8,5	5	54,08
348.303.00.1	100	110	118	14,5	8,5	5	57,00
348.304.00.1	125	125 / 135	141	17	10,5	7	74,44
348.305.00.1	150	160	169	20,6	11,5	8	111,87
348.306.00.1	200	200	207	27,2	12,5	9	142,33

Manșetă antiincendiu RS120 Geberit

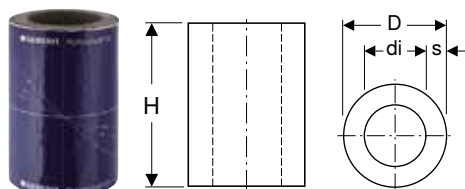

click & scan

Cod art.	DN	d, ø [mm]	di, ø [mm]	D [cm]	s [mm]	H [cm]	EUR/buc.
305.820.00.1	56	56	76	13,2	28	30	92,56
306.820.00.1	60	63	85	14,1	28	30	92,56
307.820.00.1	70	75	99	15,5	28	30	101,75
310.820.00.1	100	110	134	19	28	30	116,05
312.820.00.1	125	135	160	21,6	28	30	140,95
315.820.00.1	150	160	185	24,1	28	34	168,95

Izolare acustică

Izolații contra propagării sunetului în masă solidă

Furtun termoizolant Geberit, din PE

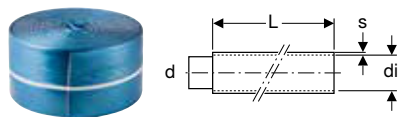

click & scan
EUR/m

Cod art.	DN	d, ø [mm]	di, ø [mm]	s [mm]	L [m]	EUR/m
305.921.00.1	56 / 60	56 / 63	74	4	15	3,16
306.921.00.1	60 / 70	63 / 75	83	4	15	3,16
307.921.00.1	70 / 90	75 / 90	97	4	15	3,16
308.921.00.1	90 / 100	90 / 110	121	4	15	4,44
310.921.00.1	100 / 125	110 / 135	145	4	15	4,44
312.921.00.1	125	135	155	4	15	4,67

Benzi termoizolante Geberit, din PE

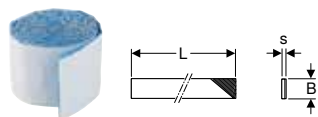

click & scan
EUR/buc.

Cod art.	s [mm]	L [m]	B [cm]	EUR/buc.
300.007.00.2	3	3,6	7	5,49

Izolații contra propagării sunetului în masă solidă și contra propagării sunetului în aer

Placă fonoabsorbantă Geberit Isol Flex tăiată la dimensiunea țevii



click & scan

Cod art.	DN	d, ø [mm]	s [mm]	L [m]	B [cm]	EUR/buc.
356.010.00.1	56 / 60	56 / 63	17	1,18	32	37,10
356.011.00.1	70	75	17	1,18	36	41,52
356.012.00.1	90	90	17	1,18	41	47,46
356.013.00.1	100	110	17	1,18	48	54,89
356.014.00.1	125	125 / 135	17	1,18	57	65,13

Placă fonoabsorbantă Geberit Isol Flex

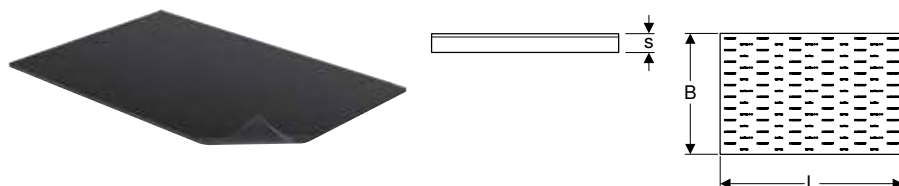

click & scan

Cod art.	s [mm]	L [m]	B [cm]	EUR/buc.
356.015.00.1	17	1,18	78	73,16

Protecție contra umezelii

Etanșări

Etanșare la umiditate Geberit cu folie de conectare Resistit®

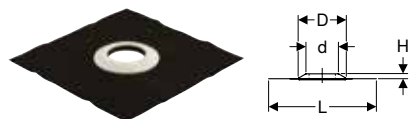

click & scan
 EUR/buc.

Cod art.	DN	Racord etanșare	d, ø [mm]	D [cm]	L [cm]	B [cm]	H [cm]	
361.673.00.1	50	EPDM (Resistit® Perfekt E)	50	13,5	50	50	2,5	53,43
363.673.00.1	56	EPDM (Resistit® Perfekt E)	56	13,5	50	50	2,5	59,89
365.673.00.1	70	EPDM (Resistit® Perfekt E)	75	19,5	50	50	2,5	61,46
366.673.00.1	90	EPDM (Resistit® Perfekt E)	90	19,5	50	50	2,5	62,89
367.673.00.1	100	EPDM (Resistit® Perfekt E)	110	19,5	50	50	2,5	62,89
368.673.00.1	125	EPDM (Resistit® Perfekt E)	125	21	50	50	2,5	72,36

Etanșare la umiditate Geberit cu folie de conectare Sarnafil® PVC

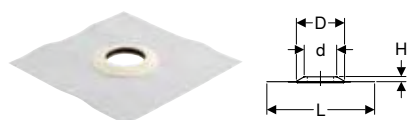

click & scan
 EUR/buc.

Cod art.	DN	Racord etanșare	d, ø [mm]	D [cm]	L [cm]	B [cm]	H [cm]	
361.674.00.1	50	PVC (Sarnafil G 410-18)	50	13,5	48	48	2,5	60,86
363.674.00.1	56	PVC (Sarnafil G 410-18)	56	13,5	48	48	2,5	61,94
365.674.00.1	70	PVC (Sarnafil G 410-18)	75	19,5	48	48	2,5	62,89
366.674.00.1	90	PVC (Sarnafil G 410-18)	90	19,5	48	48	2,5	65,04
367.674.00.1	100	PVC (Sarnafil G 410-18)	110	19,5	48	48	2,5	65,04
368.674.00.1	125	PVC (Sarnafil G 410-18)	125	21	48	48	2,5	72,36





Drenaj prin pardoseală

Drenarea suprafețelor pentru interior și exterior.....	118
Sifoane de pardoseală pentru balcoane și terase, 10 x 10 cm	118
Sifoane de pardoseală 13 x 13 cm	118
Sifoane de pardoseală pentru balcoane și terase, 13 x 13 cm	120
Sifoane de pardoseală 15 x 15 cm	120
Accesorii.....	121



Drenaj prin pardoseală

Drenarea suprafețelor pentru interior și exterior
Sifoane de pardoseală pentru balcoane și terase, 10 x 10 cm

Drenarea suprafețelor pentru interior și exterior

Sifoane de pardoseală pentru balcoane și terase, 10 x 10 cm

Folie de contact Geberit cu capac de protecție, cositorit

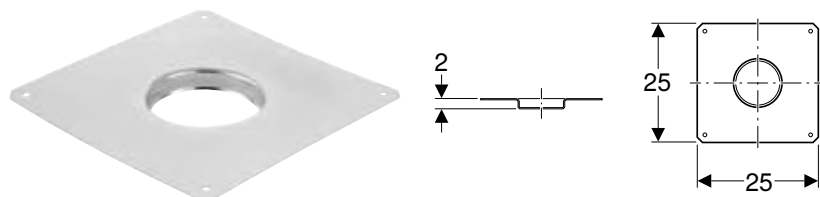

click & scan

Cod art.	Culoare/suprafață	Racord etanșare	EUR/buc.
388.123.24.1	Cositorit	Oțel CrNi, cositorit	33,61

Folie de contact Geberit cu capac de protecție, strat de acoperire

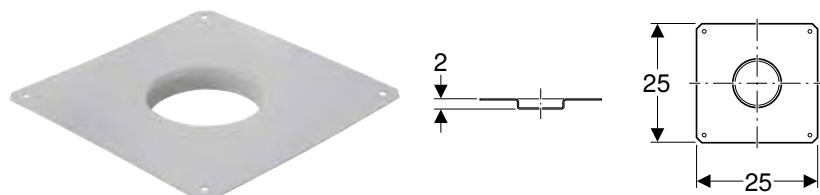

click & scan

Cod art.	Culoare/suprafață	Racord etanșare	EUR/buc.
388.124.28.1	Acoperit cu plastic	Oțel CrNi, acoperit cu PVC	53,86

Sifoane de pardoseală 13 x 13 cm

Sifon de pardoseală Geberit Varino orizontal, d50

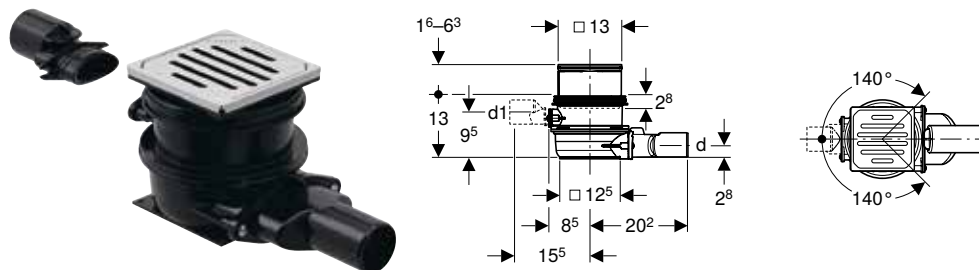

click & scan

Cod art.	d, ø [mm]	d1, ø [mm]	EUR/buc.
388.023.00.1	50	50	182,38

Accesorii

- Grătar Geberit blocabil, pentru sifoane de pardoseală 13 x 13 cm și admisii de pardoseală 13 x 13 cm → p. 122
- Element de prelungire Geberit pentru sifoane de pardoseală 13 x 13 cm și admisii de pardoseală 13 x 13 cm → p. 122
- Flanșă Geberit pentru sifoane de pardoseală 13 x 13 cm și admisii în pardoseală 13 x 13 cm → p. 122
- Flanșă de etanșare capac WC cu funcție de bideu Geberit, pentru sifon de pardoseală 13 x 13 cm și sifon cu admisie de pardoseală 13 x 13 cm → p. 122
- Sită de păr Geberit pentru sifon de pardoseală Varino 13 x 13 cm și admisie de pardoseală Varino 13 x 13 cm → p. 121
- Clapeta Geberit cu filtrare de miros, pentru sifon de pardoseală, 13 x 13 cm → p. 123
- Dop de presare Geberit pentru sifon de pardoseală Varino 13 x 13 cm → p. 123
- Suport de montaj Geberit pentru sifoane de pardoseală → p. 121

Sifon de pardoseală Geberit Varino orizontal, d110

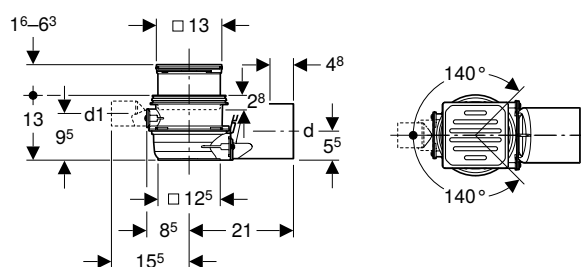

click & scan

Cod art.	d, ø [mm]	d1, ø [mm]	EUR/buc.
388.021.00.1	110	50	190,18

Accesorii

- Grătar Geberit blocabil, pentru sifoane de pardoseală 13 x 13 cm și admisii de pardoseală 13 x 13 cm → p. 122
- Element de prelungire Geberit pentru sifoane de pardoseală 13 x 13 cm și admisii de pardoseală 13 x 13 cm → p. 122
- Flanșă Geberit pentru sifoane de pardoseală 13 x 13 cm și admisii în pardoseală 13 x 13 cm → p. 122
- Flanșă de etanșare capac WC cu funcție de bideu Geberit, pentru sifon de pardoseală 13 x 13 cm și sifon cu admisie de pardoseală 13 x 13 cm → p. 122
- Sită de păr Geberit pentru sifon de pardoseală Varino 13 x 13 cm și admisie de pardoseală Varino 13 x 13 cm → p. 121
- Clapeta Geberit cu filtrare de miros, pentru sifon de pardoseală, 13 x 13 cm → p. 123
- Dop de presare Geberit pentru sifon de pardoseală Varino 13 x 13 cm → p. 123
- Suport de montaj Geberit pentru sifoane de pardoseală → p. 121

Sifon de pardoseală Geberit Varino vertical, d110

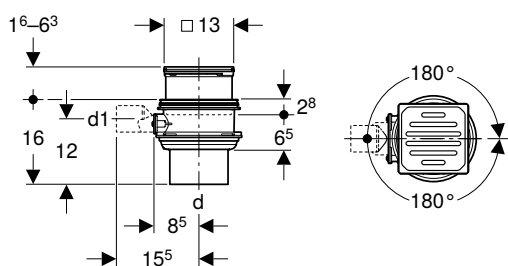

click & scan

Cod art.	d, ø [mm]	d1, ø [mm]	EUR/buc.
388.022.00.1	110	50	118,87

Accesorii

- Grătar Geberit blocabil, pentru sifoane de pardoseală 13 x 13 cm și admisii de pardoseală 13 x 13 cm → p. 122
- Element de prelungire Geberit pentru sifoane de pardoseală 13 x 13 cm și admisii de pardoseală 13 x 13 cm → p. 122
- Flanșă Geberit pentru sifoane de pardoseală 13 x 13 cm și admisii în pardoseală 13 x 13 cm → p. 122
- Flanșă de etanșare capac WC cu funcție de bideu Geberit, pentru sifon de pardoseală 13 x 13 cm și sifon cu admisie de pardoseală 13 x 13 cm → p. 122
- Sită de păr Geberit pentru sifon de pardoseală Varino 13 x 13 cm și admisie de pardoseală Varino 13 x 13 cm → p. 121
- Clapeta Geberit cu filtrare de miros, pentru sifon de pardoseală, 13 x 13 cm → p. 123
- Dop de presare Geberit pentru sifon de pardoseală Varino 13 x 13 cm → p. 123

Drenaj prin pardoseală

Drenarea suprafețelor pentru interior și exterior
Sifoane de pardoseală pentru balcoane și terase, 13 x 13 cm

Sifoane de pardoseală pentru balcoane și terase, 13 x 13 cm

Sifon de pardoseală Geberit Varino orizontal, d50

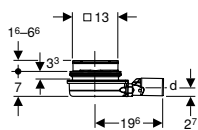

click & scan

Cod art.	d, ø [mm]	Capacitate de evacuare [l/s]	EUR/buc.
388.032.00.1	50	0,9	93,85

Accesorii

- Grătar Geberit blocabil, pentru sifoane de pardoseală 13 x 13 cm și admisii de pardoseală 13 x 13 cm → p. 122
- Element de prelungire Geberit pentru sifoane de pardoseală 13 x 13 cm și admisii de pardoseală 13 x 13 cm → p. 122
- Flanșă Geberit pentru sifoane de pardoseală 13 x 13 cm și admisii în pardoseală 13 x 13 cm → p. 122
- Flanșă de etanșare capac WC cu funcție de bideu Geberit, pentru sifon de pardoseală 13 x 13 cm și sifon cu admisie de pardoseală 13 x 13 cm → p. 122
- Clapeta Geberit cu filtrare de miros, pentru sifon de pardoseală, 13 x 13 cm → p. 123
- Sită de păr Geberit pentru sifon de pardoseală Varino 13 x 13 cm și admisie de pardoseală Varino 13 x 13 cm → p. 121
- Inserție de sifon Geberit cu înălțimea gârzii hidraulice 27 mm, pentru admisie de pardoseală Varino 13 x 13 cm → p. 122

Sifon de pardoseală Geberit Varino vertical, d50

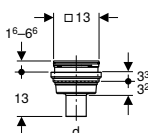

click & scan

Cod art.	d, ø [mm]	Capacitate de evacuare [l/s]	EUR/buc.
388.033.00.1	50	2	86,81

Accesorii

- Grătar Geberit blocabil, pentru sifoane de pardoseală 13 x 13 cm și admisii de pardoseală 13 x 13 cm → p. 122
- Element de prelungire Geberit pentru sifoane de pardoseală 13 x 13 cm și admisii de pardoseală 13 x 13 cm → p. 122
- Flanșă Geberit pentru sifoane de pardoseală 13 x 13 cm și admisii în pardoseală 13 x 13 cm → p. 122
- Flanșă de etanșare capac WC cu funcție de bideu Geberit, pentru sifon de pardoseală 13 x 13 cm și sifon cu admisie de pardoseală 13 x 13 cm → p. 122
- Sită de păr Geberit pentru sifon de pardoseală Varino 13 x 13 cm și admisie de pardoseală Varino 13 x 13 cm → p. 121
- Clapeta Geberit cu filtrare de miros, pentru sifon de pardoseală, 13 x 13 cm → p. 123
- Inserție de sifon Geberit cu înălțimea gârzii hidraulice 27 mm, pentru admisie de pardoseală Varino 13 x 13 cm → p. 122

Sifoane de pardoseală 15 x 15 cm

Sifon cu admisie de pardoseală Geberit HDPE, grătar cu fante 15 x 15 cm

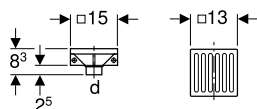

click & scan

Cod art.	d, ø [mm]	Capacitate de evacuare [l/s]	EUR/buc.
361.666.16.1	50	1,2	44,04

Accesorii

Grătar cu fante Geberit, rotund, care nu suportă greutate



Cod art.
388.134.00.1



click & scan
EUR/buc.

73,35

Grătar cu fante Geberit, rotund, care suportă greutate



Cod art.
388.133.00.1



click & scan
EUR/buc.

152,08

Prelungitor de pâlnie Geberit pentru sifon de pardoseală 10 x 10 cm

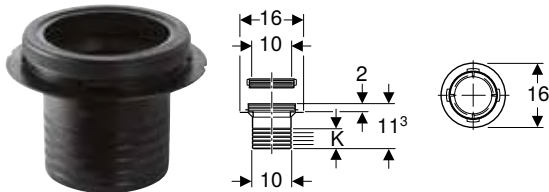

Cod art.
363.660.00.1

K
[cm]

5



click & scan

EUR/buc.

12,09

Suport de montaj Geberit pentru sifoane de pardoseală

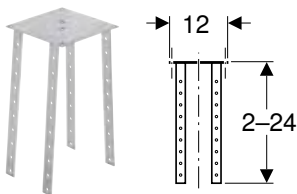

Cod art.
388.132.00.1



click & scan

EUR/buc.

40,90

Sită de păr Geberit pentru sifon de pardoseală Varino 13 x 13 cm și admisie de pardoseală Varino 13 x 13 cm

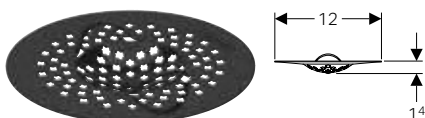

Cod art.
388.105.00.1



click & scan
EUR/buc.

8,58

Drenaj prin pardoseală

Drenarea suprafețelor pentru interior și exterior
Sifoane de pardoseală pentru balcoane și terase, 13 x 13 cm

Flanșă Geberit pentru sifoane de pardoseală 13 x 13 cm și admisii în pardoseală 13 x 13 cm

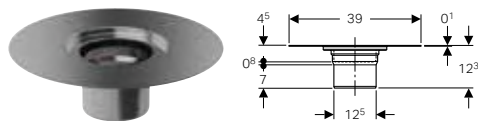

Cod art.
388.101.00.1



click & scan
EUR/buc.
171,96

Flanșă de etanșare capac WC cu funcție de bideu Geberit, pentru sifon de pardoseală 13 x 13 cm și sifon cu admisie de pardoseală 13 x 13 cm

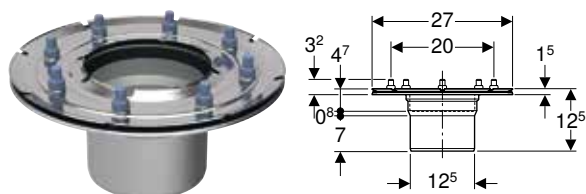

Cod art.
388.102.00.1



EUR/buc.
169,31

Insertie de sifon Geberit cu înălțimea găzii hidraulice 27 mm, pentru admisie de pardoseală Varino 13 x 13 cm

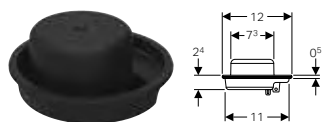

Cod art.
388.108.00.1



click & scan
EUR/buc.
23,04

Element de prelungire Geberit pentru sifoane de pardoseală 13 x 13 cm și admisii de pardoseală 13 x 13 cm

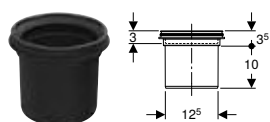

Cod art.
388.100.00.1

d, ø
[mm]
125



click & scan
EUR/buc.
17,75

Grătar Geberit blocabil, pentru sifoane de pardoseală 13 x 13 cm și admisii de pardoseală 13 x 13 cm



Cod art.
388.107.00.1



click & scan
EUR/buc.
52,85

Clapeta Geberit cu filtrare de miros, pentru sifon de pardoseală, 13 x 13 cm



click & scan
EUR/buc.

Cod art.		
388.106.00.1		31,08

Dop de presare Geberit pentru sifon de pardoseală Varino 13 x 13 cm



click & scan
EUR/buc.

Cod art.	d, ø [mm]	
388.109.00.1	63	31,08

Capac Geberit, înfiletabil, cu capac de închidere

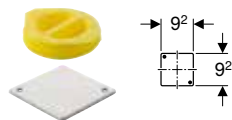

click & scan
EUR/buc.

Cod art.		
388.129.00.1		12,44





Geberit FlowFit

Prezentare generală a utilizărilor – Geberit FlowFit	127
Țevi de sistem ML.....	128
Țevi de sistem instalație de încălzire ML	130
Conducte SL	131
Fitinguri.....	132
Cuple	132
Reducții	133
Coturi	133
Teuri	134
Adaptoare fixe	136
Adaptoare și conexiuni, cu posibilitate de desfacere	140
Închizători.....	147
Racorduri	148
Distribuitor cu racord filetat	150
Adaptoare și conexiuni pentru instalație de încălzire, cu posibilitate de desfacere	150
Racorduri pentru încălzire	151
Accesorii.....	152
Izolații pentru racorduri.....	152
Etanșări pentru țevi și fittinguri	152
Garnituri pentru fittinguri	153
Dispozitive de fixare pentru țevi	153
Dispozitive de fixare pentru racorduri.....	155
Etanșări sistem.....	157
Seturi șuruburi pentru conexiuni cu flanșă	158
Material de consum	159



Prezentare generală a utilizărilor – Geberit FlowFit

Geberit România, Versiune: December 2023

Domenii de utilizare	Temperatură de operare	Maximum operating pressure	Țevi		
			ML	ML therm NPW	PB
Medii fluide					
Pentru apă potabilă rece și caldă	0–70 °C ²⁾	10 bar /1000 kPa	✓		✓
For cold potable water	0–20 °C	16 bar / 1600 kPa ⁵⁾	✓		✓
Pentru apă de răcire și de încălzire fără antigel	0–80 °C ³⁾	10 bar /1000 kPa	✓	✓	
Pentru apă de răcire și de încălzire fără antigel	-10 – +40 °C ⁴⁾	10 bar /1000 kPa	✓	✓	
Pentru apa de operare și de proces	0–70 °C	10 bar /1000 kPa	6)	6)	6)
Pentru apele tratate	0–70 °C	10 bar /1000 kPa	✓ ⁷⁾	✓ ⁷⁾	✓ ⁷⁾
Pentru apă de ploaie cu valoarea > 6.0	0–70 °C	10 bar /1000 kPa	✓	✓	✓
Pentru apă de mare	0–70 °C	10 bar /1000 kPa	✓	✓	
Pentru produse chimice și fluide tehnice	La cerere	La cerere	6)	6)	6)
Medii gazoase					
Pentru aer comprimat (clasa de puritate a uleiului 0–3)	0–70 °C	10 bar /1000 kPa	✓	✓	
Pentru presiune negativă ¹⁾	0–70 °C	Abs. ≥ 0,2 bar/20 kPa	✓	✓	

✓ Utilizare generală aprobată, dacă sunt îndeplinite condițiile suplimentare definite conform notelor de subsol

¹⁾ Presiune negativă utilă pentru sisteme de țevi Geberit:

Presiunea negativă utilă rezultă din presiunea aerului la locul de instalație minus presiunea absolută de 200 mbar.

Exemplu: Presiunea aerului 980 mbar - Presiunea absolută 200 mbar = Presiunea negativă utilă în sistemul de conducte 780 mbar

²⁾ Temperatură în caz de avarie conform EN 806-2: T_{mal} = 95 °C, total 100 h în timpul duratei de viață

³⁾ Temperatură în caz de avarie conform ISO 10508:2006: T_{mal} = 100 °C, total 100 h în timpul duratei de viață

⁴⁾ Temperaturi mai ridicate doar cu autorizarea Geberit

⁵⁾ 10 bar / 1000 kPa pentru MasterFix și MeplaFix

⁶⁾ Following Geberit approval

⁷⁾ Domeniu de aplicare în conformitate cu informațiile tehnice (TI) "Ape tratate"

⁸⁾ Valoarea pH-ului ≥ 7,0 admisă în combinație cu bronz siliconic sau alamă

⁹⁾ Clasă de puritate a uleiului conform ISO 8573-1:2010E; pentru detalii referitoare la umiditate și particule, vezi Informațiile tehnice "Sisteme de conducte Geberit pentru instalații de aer comprimat"



- Pentru fiecare aplicație se vor respecta condițiile de utilizare din autorizațiile de referință, norme și reglementări tehnice. Ele pot diferi de datele specificate

	Fitinguri					Garnituri inelare	Garnituri plate pentru îmbinări filetate	Garnituri de flanșă
	Plastic	Fontă roșie fără plumb	Bronz silicat fără plumb	Alamă	Oțel inoxidabil	EPDM negru	Fibre compozite	Fibre compozite
	✓	✓	✓	✓	✓	✓	✓	✓
	✓	✓	✓	✓	✓	✓	✓	✓
	✓	✓	✓	✓	✓	✓	✓	✓
	✓	✓	✓	✓	✓	✓	✓	✓
	6)	6)	6)		6)	6)	6)	6)
	✓ ⁷⁾	✓ ⁷⁾	✓ ⁷⁾		✓ ⁷⁾	✓ ⁷⁾	✓ ⁷⁾	✓ ⁷⁾
	✓	✓	✓ ⁸⁾	✓ ⁸⁾	✓	✓	✓	✓
	✓	✓	✓			✓	✓	✓
	6)	6)	6)	6)	6)	6)	6)	6)
	✓	✓	✓	✓	✓	✓ ⁹⁾	✓	✓
	✓	✓	✓	✓	✓	✓	✓	✓



Țevi de sistem ML

Nou

Țeavă multistrat Geberit, ML, la bară

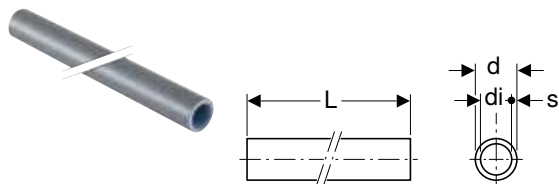

click & scan

Cod art.	DN	d, ø [mm]	di, ø [mm]	s [mm]	EUR/m
L / lungime: 3 m					
619.010.00.1	12	16	12	2	3,60
619.011.00.1	15	20	16	2	5,13
619.012.00.1	20	25	20	2,5	8,45
619.013.00.1	25	32	26,4	2,8	12,31
619.014.00.1	32	40	34	3	17,43
619.015.00.1	40	50	42,4	3,8	24,59
619.016.00.1	50	63	55	4	37,07
L / lungime: 5 m					
619.020.00.1	12	16	12	2	3,46
619.021.00.1	15	20	16	2	4,88
619.022.00.1	20	25	20	2,5	8,01
619.023.00.1	25	32	26,4	2,8	11,91
619.024.00.1	32	40	34	3	16,59
619.025.00.1	40	50	42,4	3,8	23,50
619.026.00.1	50	63	55	4	35,41
619.027.00.1	65	75	65,8	4,6	56,11

Livrabil din April 2024

Accesorii

- Foarfecă Geberit → p. 311
- Instrument de calibrare Geberit FlowFit → p. 310
- Aparat Geberit de tăiat țevi ML → p. 310
- Set de montaj în punct fix Geberit → p. 153

Nou

Țeavă multistrat Geberit, ML, la colac

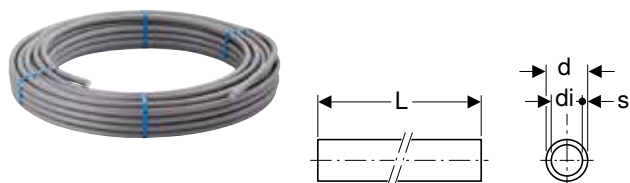

click & scan

Cod art.	DN	d, ø [mm]	di, ø [mm]	s [mm]	L [m]	EUR/m
619.050.00.1	12	16	12	2	50	3,04
619.060.00.1	12	16	12	2	120	2,91
619.070.00.1	12	16	12	2	250	2,91
619.051.00.1	15	20	16	2	50	4,15
619.061.00.1	15	20	16	2	100	4,04
619.052.00.1	20	25	20	2,5	50	6,92
619.054.00.1	25	32	26,4	2,8	25	10,25

Livrabil din April 2024

Accesorii

- Foarfecă Geberit → p. 311
- Instrument de calibrare Geberit FlowFit → p. 310
- Aparat Geberit de tăiat țevi ML → p. 310

Nou

Țeavă multistrat Geberit, ML, în țeavă de protecție, la colac

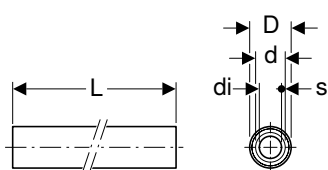

click & scan

Cod art.	DN	d, ø [mm]	di, ø [mm]	D [cm]	s [mm]	L [m]	EUR/m
619.220.00.1	12	16	12	2,7	2	50	3,73
619.221.00.1	15	20	16	3,1	2	50	5,28

Livrabil din April 2024

Accesorii

- Foarfecă Geberit → p. 311
- Instrument de calibrare Geberit FlowFit → p. 310

Nou

Țeavă multistrat Geberit, ML, produse rotunde preizolate, la colac

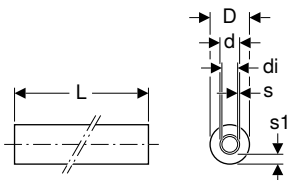

click & scan

Cod art.	DN	d, ø [mm]	di, ø [mm]	D [cm]	s1 [mm]	s [mm]	L [m]	EUR/m
Izolație: 6 mm								
619.100.00.1	12	16	12	2,8	6	2	50	3,88
619.101.00.1	15	20	16	3,2	6	2	50	5,39
619.102.00.1	20	25	20	3,7	6	2,5	25	8,98
619.103.00.1	25	32	26,4	4,4	6	2,8	25	13,26
Izolație: 10 mm								
619.120.00.1	12	16	12	3,6	10	2	50	4,39
619.121.00.1	15	20	16	4	10	2	50	6,08
619.122.00.1	20	25	20	4,5	10	2,5	25	10,25
619.123.00.1	25	32	26,4	5,2	10	2,8	25	14,77
Izolație: 13 mm								
619.140.00.1	12	16	12	4,2	13	2	50	5,39
619.141.00.1	15	20	16	4,6	13	2	50	7,30
619.142.00.1	20	25	20	5,1	13	2,5	25	12,31
619.143.00.1	25	32	26,4	5,8	13	2,8	25	17,92
Izolație: 26 mm								
619.160.00.1	12	16	12	6,8	26	2	25	6,08
619.161.00.1	15	20	16	7,2	26	2	20	8,34
619.162.00.1	20	25	20	7,7	26	2,5	15	13,82

Livrabil din April 2024

Accesorii

- Foarfecă Geberit → p. 311
- Aparat Geberit de tăiat țevi ML → p. 310
- Instrument de calibrare Geberit FlowFit → p. 310



Nou

Țeavă multistrat Geberit, ML, produse rotunde preizolate, la colac

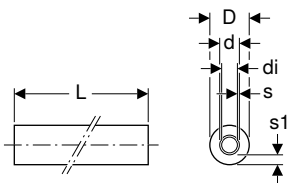

click & scan

Cod art.	DN	d, ø [mm]	di, ø [mm]	D [cm]	s1 [mm]	s [mm]	L [m]	EUR/m
Izolație: 6 mm								
619.110.00.1	12	16	12	2,8	6	2	50	3,88
619.111.00.1	15	20	16	3,2	6	2	50	5,39
619.112.00.1	20	25	20	3,7	6	2,5	25	8,98

Livrabil din April 2024

Accesorii

- Foarfecă Geberit → p. 311
- Instrument de calibrare Geberit FlowFit → p. 310

Țevi de sistem instalație de încălzire ML

Nou

Țeavă multistrat Geberit, ML, Therm, la colac

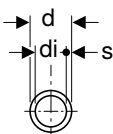

click & scan

Cod art.	DN	d, ø [mm]	di, ø [mm]	s [mm]	L [m]	EUR/m
619.130.00.1	12	16	12	2	120	2,33
619.131.00.1	12	16	12	2	250	1,89
619.133.00.1	15	20	16	2	100	3,00
619.135.00.2	20	25	20	2,5	50	5,52

Livrabil din April 2024

Accesorii

- Foarfecă Geberit → p. 311
- Aparat Geberit de tăiat țevi ML → p. 310
- Instrument de calibrare Geberit FlowFit → p. 310

Nou

Țeavă multistrat Geberit, ML, Therm, produse rotunde preizolate, la colac

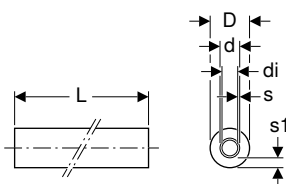

click & scan

Cod art.	DN	d, ø [mm]	di, ø [mm]	D [cm]	s1 [mm]	s [mm]	L [m]	EUR/m
Izolație: 6 mm								
619.150.00.1	12	16	12	2,8	6	2	50	3,13
619.151.00.1	15	20	16	3,2	6	2	50	4,31
619.152.00.1	20	25	20	3,7	6	2,5	25	7,21
Izolație: 10 mm								
619.170.00.1	12	16	12	3,6	10	2	50	3,51
619.171.00.1	15	20	16	4	10	2	50	4,88
619.172.00.1	20	25	20	4,5	10	2,5	25	9,82

Livrabil din April 2024

Accesorii

- Foarfecă Geberit → p. 311
- Aparat Geberit de tăiat țevi ML → p. 310
- Instrument de calibrare Geberit FlowFit → p. 310

Nou

Țeavă multistrat Geberit, ML, Therm, produse excentrice preizolate, la colac

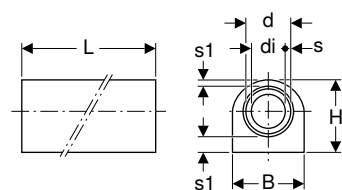

click & scan

Cod art.	DN	d, ø [mm]	Izolație [mm]	di, ø [mm]	s1 [mm]	s [mm]	L [m]	B [cm]	H [cm]	EUR/m
619.180.00.1	12	16	13	12	6 / 13	2	50	3,9	3,9	5,39
619.181.00.1	15	20	13	16	6 / 13	2	50	4,3	4,3	7,30
619.182.00.1	20	25	13	20	6 / 13	2,5	25	4,9	4,9	12,31

Livrabil din April 2024

Accesorii

- Foarfecă Geberit → p. 311
- Aparat Geberit de tăiat țevi ML → p. 310
- Instrument de calibrare Geberit FlowFit → p. 310

Conducte SL

Țeavă monostrat Geberit SL cu EVOH, NPW, la colac

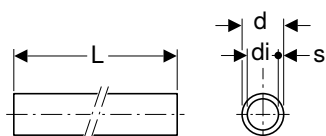

click & scan

Cod art.	DN	d, ø [mm]	di, ø [mm]	s [mm]	L [m]	EUR/m
617.170.00.1	12	16	12	2	120	1,25
617.180.00.1	12	16	12	2	240	1,25
617.190.00.1	12	16	12	2	600	1,25
617.171.00.1	15	20	16	2	120	2,09
617.181.00.1	15	20	16	2	240	2,09

Fitinguri

Mufe

Nou

Mufă Geberit FlowFit

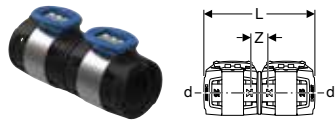

click & scan
EUR/buc.

Cod art.	DN	d, ø [mm]	L [cm]	Z [cm]	
620.010.00.1	12	16	7,7	1,2	4,15
620.011.00.1	15	20	7,7	1,2	4,88
620.012.00.1	20	25	7,7	1,2	7,19
620.013.00.1	25	32	8,7	1,5	10,25
620.014.00.1	32	40	8,7	1,5	15,77
620.015.00.1	40	50	14,1	2,2	24,30
620.016.00.1	50	63	15,1	2,4	45,29
620.017.00.1	65	75	15,1	2,4	82,93

Livrabil din April 2024

Nou

Mufă lungă Geberit FlowFit

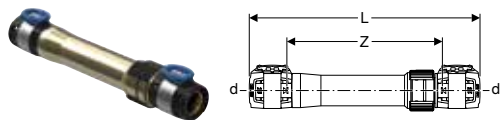

click & scan
EUR/buc.

Cod art.	DN	d, ø [mm]	L [cm]	Z [cm]	
620.020.00.1	12	16	20	13,5	81,27
620.021.00.1	15	20	20	13,5	116,51
620.022.00.1	20	25	20	13,5	151,69
620.023.00.1	25	32	22,2	15	189,60
620.024.00.1	32	40	23,5	16,3	257,39
620.025.00.1	40	50	34	22	352,15

Livrabil din April 2024

Reducții

Nou

Reducție Geberit FlowFit

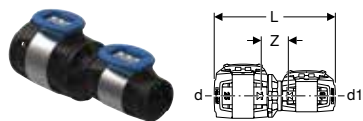

click & scan
EUR/buc.

Cod art.	DN	d, ø [mm]	d1, ø [mm]	L [cm]	Z [cm]	
620.031.00.1	15 / 12	20	16	8,4	1,9	4,88
620.032.00.1	20 / 12	25	16	8,4	1,9	7,19
620.042.00.1	20 / 15	25	20	8,4	1,9	7,19
620.003.00.1	25 / 12	32	16	8,9	2	10,25
620.033.00.1	25 / 15	32	20	8,9	2	10,25
620.043.00.1	25 / 20	32	25	8,9	2	10,25
620.034.00.1	32 / 15	40	20	9,2	2,3	15,77
620.044.00.1	32 / 20	40	25	8,9	2	15,77
620.054.00.1	32 / 25	40	32	9,4	2,1	15,77
620.035.00.1	40 / 25	50	32	12,2	2,7	24,30
620.045.00.1	40 / 32	50	40	12,2	2,7	24,30
620.036.00.1	50 / 32	63	40	12,9	3	45,29
620.046.00.1	50 / 40	63	50	15,7	3,4	45,29
620.037.00.1	65 / 32	75	40	13,6	3,7	82,93
620.047.00.1	65 / 40	75	50	15,7	3,4	82,93
620.057.00.1	65 / 50	75	63	16,2	3,5	82,93

Livrabil din April 2024

Coturi

Nou

Cot Geberit FlowFit

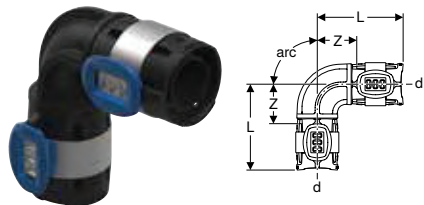

click & scan

Cod art.	DN	d, ø [mm]	L [cm]	Z [cm]	EUR/buc.
arc / cot: 45°					
620.061.00.1	15	20	5,5	1,9	6,63
620.062.00.1	20	25	5,2	1,9	9,65
620.063.00.1	25	32	5,9	2,3	12,71
620.064.00.1	32	40	5,9	2,5	21,35
620.065.00.1	40	50	9	3	32,63
620.066.00.1	50	63	9,9	3,5	50,88
620.067.00.1	65	75	9,9	3,5	96,72
arc / cot: 90°					
620.070.00.1	12	16	5,8	2,5	5,28
620.071.00.1	15	20	6	2,7	6,63
620.072.00.1	20	25	6,2	2,9	9,65
620.073.00.1	25	32	7	3,4	12,71
620.074.00.1	32	40	7,5	3,9	21,35
620.075.00.1	40	50	11,5	5,6	32,63
620.076.00.1	50	63	12,5	6,1	50,88
620.077.00.1	65	75	13	6,7	96,72

Livrabil din April 2024

Teuri

Nou

Teu Geberit FlowFit, egal

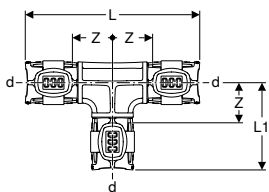

click & scan

Cod art.	DN	d, ø [mm]	arc [°]	L [cm]	L1 [cm]	Z [cm]	EUR/buc.
620.080.00.1	12	16	90	11,5	5,8	2,5	7,61
620.081.00.1	15	20	90	11,9	6	2,7	8,83
620.082.00.1	20	25	90	12,4	6,2	2,9	13,26
620.083.00.1	25	32	90	14	7	3,4	19,36
620.084.00.1	32	40	90	15	7,5	3,9	27,65
620.085.00.1	40	50	90	23	11,5	5,6	45,60
620.086.00.1	50	63	90	24,9	12,5	6,1	76,53
620.087.00.1	65	75	90	26,1	13,1	6,7	154,71

Livrabil din April 2024

Nou

Teu redus Geberit FlowFit

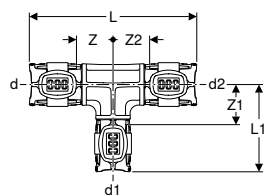

click & scan

Cod art.	DN	d, ø [mm]	d1, ø [mm]	d2, ø [mm]	arc [°]	L [cm]	L1 [cm]	Z [cm]	Z1 [cm]	Z2 [cm]	EUR/buc.
620.121.00.1	12 / 15 / 12	16	20	16	90	11,9	5,8	2,7	2,5	2,7	8,83
620.101.00.1	15 / 12 / 12	20	16	16	90	11,5	6	2,4	2,7	2,5	8,83
620.111.00.1	15 / 12 / 15	20	16	20	90	11,5	6	2,5	2,7	2,5	8,83
620.131.00.1	15 / 15 / 12	20	20	16	90	11,9	6	2,7	2,7	2,7	8,83
620.132.00.1	15 / 20 / 15	20	25	20	90	12,4	6	2,9	2,7	2,9	13,26
620.100.00.1	20 / 12 / 12	25	16	16	90	11,5	6	2,4	2,7	2,5	13,26
620.108.00.1	20 / 12 / 15	25	16	20	90	11,9	6,2	2,7	2,9	2,7	13,26
620.112.00.1	20 / 12 / 20	25	16	25	90	11,5	6,2	2,5	2,9	2,5	13,26
620.102.00.1	20 / 15 / 15	25	20	20	90	11,9	6,2	2,7	2,9	2,7	13,26
620.122.00.1	20 / 15 / 20	25	20	25	90	11,9	6,2	2,7	2,9	2,7	13,26
620.142.00.1	20 / 20 / 15	25	25	20	90	12,4	6,2	2,9	2,9	2,9	13,26
620.113.00.1	25 / 12 / 25	32	16	32	90	12	6,7	2,4	3,4	2,4	19,36
620.123.00.1	25 / 15 / 20	32	20	25	90	12,2	6,7	2,7	3,4	2,7	19,36
620.133.00.1	25 / 15 / 25	32	20	32	90	12,5	6,7	2,7	3,4	2,7	19,36
620.103.00.1	25 / 20 / 20	32	25	25	90	12,7	6,7	2,9	3,4	2,9	19,36
620.143.00.1	25 / 20 / 25	32	25	32	90	13	6,7	2,9	3,4	2,9	19,36
620.104.00.1	32 / 15 / 32	40	20	40	90	12,7	7,2	2,8	3,9	2,8	27,65
620.114.00.1	32 / 20 / 32	40	25	40	90	13,2	7,1	3	3,8	3	27,65
620.124.00.1	32 / 25 / 32	40	32	40	90	14,2	7,4	3,5	3,8	3,5	27,65
620.115.00.1	40 / 20 / 40	50	25	50	90	18,9	8,3	3,5	5	3,5	45,60
620.125.00.1	40 / 25 / 40	50	32	50	90	19,9	8,6	4	5	4	45,60
620.105.00.1	40 / 32 / 32	50	40	40	90	17,9	8,7	4	5	4,4	45,60
620.135.00.1	40 / 32 / 40	50	40	50	90	20,7	8,7	4,4	5	4,4	45,60
620.106.00.1	50 / 20 / 50	63	25	63	90	19,4	9	3,4	5,7	3,4	76,53
620.116.00.1	50 / 25 / 50	63	32	63	90	20,4	9,3	3,9	5,7	3,9	76,53
620.126.00.1	50 / 32 / 50	63	40	63	90	21,2	9,4	4,3	5,8	4,3	76,53
620.136.00.1	50 / 40 / 50	63	50	63	90	23,5	12,2	5,4	6,3	5,4	76,53
620.107.00.1	65 / 20 / 65	75	25	75	90	19,4	9,6	3,4	6,3	3,4	154,71
620.117.00.1	65 / 25 / 65	75	32	75	90	20,4	9,9	3,9	6,3	3,9	154,71

Livrabil din April 2024

Cod art.	DN	d, ø [mm]	d1, ø [mm]	d2, ø [mm]	arc [°]	L [cm]	L1 [cm]	Z [cm]	Z1 [cm]	Z2 [cm]	EUR/buc.
620.127.00.1	65 / 32 / 65	75	40	75	90	21,2	10	4,3	6,4	4,3	154,71
620.137.00.1	65 / 40 / 65	75	50	75	90	23,5	12,8	5,4	6,9	5,4	154,71
620.147.00.1	65 / 50 / 65	75	63	75	90	24,9	13	6,1	6,7	6,1	154,71

Livrabil din April 2024

Nou

Teu Geberit FlowFit cu file interior

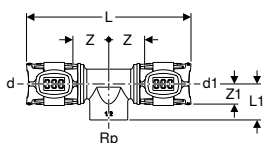

click & scan

Cod art.	DN	d, ø [mm]	Rp ["]	d1, ø [mm]	arc [°]	L [cm]	L1 [cm]	Z [cm]	Z1 [cm]	EUR/buc.
620.150.00.1	12 / 15 / 12	16	1/2"	16	90	11,9	2,4	2,7	1,1	22,66
620.151.00.1	15	20	1/2"	20	90	11,9	2,4	2,7	1,1	26,56
620.157.00.1	20 / 15 / 15	25	1/2"	20	90	11,9	2,6	2,7	1,3	35,41
620.152.00.1	20 / 15 / 20	25	1/2"	25	90	11,9	2,6	2,7	1,3	35,41
620.162.00.1	20	25	3/4"	25	90	12,8	2,8	3,1	1,5	35,41
620.153.00.1	25 / 15 / 25	32	1/2"	32	90	13	3,1	2,9	1,3	46,47
620.163.00.1	25 / 20 / 25	32	3/4"	32	90	13,4	3,1	3,1	1,7	46,47
620.173.00.1	25	32	1"	32	90	14,4	3,1	3,6	1,6	46,47
620.154.00.1	32 / 15 / 32	40	1/2"	40	90	13,4	3,4	3,1	1,9	56,38
620.164.00.1	32 / 20 / 32	40	3/4"	40	90	14,7	3,5	3,8	2,1	56,38
620.174.00.1	32 / 25 / 32	40	1"	40	90	14,7	4,2	3,8	2,3	56,38
620.184.00.1	32	40	1 1/4"	40	90	15,4	4,4	4,1	2,3	56,38
620.155.00.1	40 / 15 / 40	50	1/2"	50	90	18,5	4,1	3,3	2,4	79,58
620.185.00.1	40	50	1 1/2"	50	90	22	4,6	5,1	2,3	79,58
620.165.00.1	40 / 20 / 40	50	3/4"	50	90	20,2	4	4,2	2,6	79,58
620.175.00.1	40 / 25 / 40	50	1"	50	90	20,2	4,6	4,2	2,5	79,58
620.156.00.1	50 / 15 / 50	63	1/2"	63	90	20,5	4,6	3,9	3,1	193,41
620.166.00.1	50 / 25 / 50	63	1"	63	90	22	5,1	4,7	3,2	193,41
620.176.00.1	50	63	2"	63	90	24,6	6,6	6	4	193,41
620.177.00.1	65 / 25 / 65	75	1"	75	90	21,6	5,4	4,5	3,5	303,94

Livrabil din April 2024

Nou

Teu Geberit FlowFit cu file interior pe lateral

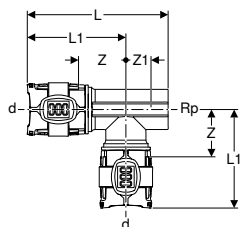

click & scan

Cod art.	DN	d, ø [mm]	Rp ["]	arc [°]	L [cm]	L1 [cm]	Z [cm]	Z1 [cm]	EUR/buc.
620.353.00.1	25 / 25 / 15	32	1/2"	90	10,2	7,1	3,4	1,6	46,56
620.354.00.1	32 / 32 / 15	40	1/2"	90	11,1	7,6	3,9	2	57,64
620.355.00.1	40 / 40 / 15	50	1/2"	90	15,5	11,7	5,6	2,3	79,81

Livrabil din April 2024

Adaptoare fixe

Nou

Adaptor Geberit FlowFit la Geberit Mepla

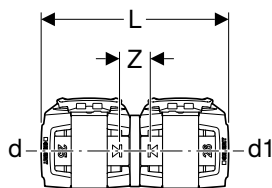

click & scan

Cod art.	DN	d, ø [mm]	d1, ø [mm]	s1 [mm]	L [cm]	Z [cm]	EUR/buc.
620.090.00.1	12	16	16	2,25	7,8	1,3	7,72
620.091.00.1	15	20	20	2,5	7,8	1,3	9,96
620.092.00.1	20	25	26	3	7,8	1,3	13,82
620.093.00.1	25	32	32	3	8,8	1,6	18,82
620.094.00.1	32	40	40	3,5	8,8	1,6	22,11
620.095.00.1	40	50	50	4	14	2,1	49,75
620.096.00.1	50	63	63	4,5	15	2,3	77,37
620.097.00.1	65	75	75	4,7	15	2,3	104,99

Livrabil din April 2024

Nou

Adaptor Geberit FlowFit la Geberit Mapress, cu capăt drept

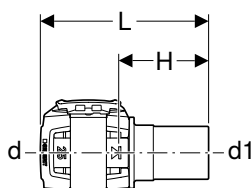

click & scan

Cod art.	DN	d, ø [mm]	d1, ø [mm]	L [cm]	H [cm]	EUR/buc.
620.230.00.1	12 / 10	16	12	6,8	3,5	7,72
620.240.00.1	12	16	15	6,9	3,6	7,72
620.231.00.1	15 / 12	20	15	6,9	3,6	9,96
620.241.00.1	15	20	18	6,9	3,6	9,96
620.242.00.1	15 / 20	20	22	7	3,7	9,96
620.232.00.1	20	25	22	7	3,7	13,82
620.233.00.1	25	32	28	7,7	4,1	18,82
620.234.00.1	32	40	35	8	4,4	22,11
620.235.00.1	40	50	42	12,8	6,9	49,75
620.236.00.1	50	63	54	13,8	7,5	77,37

Livrabil din April 2024

Nou

Adaptor Geberit FlowFit la Geberit Mapress, cu capăt drept, din oțel inoxidabil

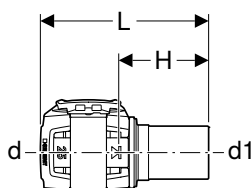

click & scan

Cod art.	DN	d, ø [mm]	d1, ø [mm]	L [cm]	H [cm]	EUR/buc.
620.250.00.1	12	16	15	7,1	3,8	18,40
620.252.00.1	15 / 20	20	22	7,2	3,9	21,66

Livrabil din April 2024

Cod art.	DN	d, ø [mm]	d1, ø [mm]	L [cm]	H [cm]	EUR/buc.
620.253.00.1	20	25	22	7,2	3,9	27,07
620.254.00.1	25	32	28	7,9	4,3	35,27
620.255.00.1	32	40	35	8,2	4,6	47,69
620.256.00.1	40	50	42	12,5	6,6	81,27
620.257.00.1	50	63	54	14,2	7,9	105,68

Livrabil din April 2024

Nou

Adaptor Geberit FlowFit la Geberit Mapress, cu mufă de sertizare, din oțel inoxidabil

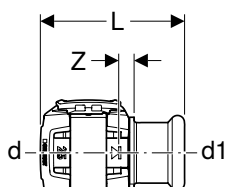

click & scan

Cod art.	DN	d, ø [mm]	d1, ø [mm]	L [cm]	Z [cm]	EUR/buc.
620.329.00.1	12 / 10	16	12	5,4	0,6	18,40
620.332.00.1	12	16	15	5,6	0,6	18,40
620.347.00.1	15 / 12	20	15	5,6	0,6	21,66
620.333.00.1	15	20	18	5,6	0,6	21,66
620.334.00.1	15 / 20	20	22	5,7	0,6	21,66
620.335.00.1	20	25	22	5,7	0,6	27,07
620.336.00.1	25	32	28	6,4	0,8	35,27
620.337.00.1	32	40	35	6,7	0,8	47,69
620.338.00.1	40	50	42	9,7	1,1	81,27
620.339.00.1	50	63	54	10,7	1,2	105,68

Livrabil din April 2024

Nou

Adaptor Geberit FlowFit la sistem terț

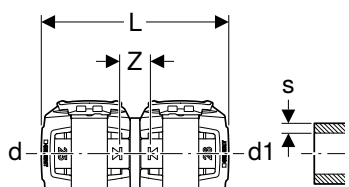

click & scan

Cod art.	DN	d, ø [mm]	d1, ø [mm]	s [mm]	L [cm]	Z [cm]	EUR/buc.
620.703.00.1	12	16	16	2-2,2	7,8	1,3	13,08
620.711.00.1	15	20	20	2-2,25	7,8	1,3	16,41
620.712.00.1	15	20	20	2,8-2,9	7,8	1,3	16,41
620.723.00.1	20	25	25	2,5-2,7	7,8	1,3	23,95
620.724.00.1	20	25	25	3,5-3,7	7,8	1,3	23,95
620.727.00.1	20	25	26	3-3	7,8	1,3	32,37

Livrabil din April 2024

Nou

Adaptoare Geberit FlowFit cu filet exterior

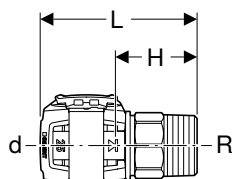

click & scan

Cod art.	DN	d, ø [mm]	R ["]	L [cm]	H [cm]	SW [mm]	EUR/buc.
620.300.00.1	12 / 10	16	3/8"	6,1	2,8	18	6,63
620.310.00.1	12 / 15	16	1/2"	6,1	2,8	22	6,63
620.320.00.1	12 / 20	16	3/4"	6,5	3,2	27	6,63
620.301.00.1	15 / 10	20	3/8"	6,1	2,8	18	9,14
620.311.00.1	15	20	1/2"	6,4	3,1	22	9,14
620.321.00.1	15 / 20	20	3/4"	6,5	3,2	27	9,14
620.308.00.1	15 / 25	20	1"	6,4	3,1	34	9,14
620.302.00.1	20 / 15	25	1/2"	6,4	3,1	22	11,60
620.312.00.1	20	25	3/4"	6,8	3,5	27	11,60
620.322.00.1	20 / 25	25	1"	6,6	3,3	34	11,60
620.309.00.1	25 / 20	32	3/4"	7,5	3,9	27	14,37
620.303.00.1	25	32	1"	7,5	3,9	34	14,37
620.313.00.1	25 / 32	32	1 1/4"	7,2	3,6	43	14,37
620.304.00.1	32 / 25	40	1"	7,4	3,8	47	21,57
620.314.00.1	32	40	1 1/4"	7,4	3,8	47	21,57
620.324.00.1	32 / 40	40	1 1/2"	7,3	3,7	49	21,57
620.305.00.1	40	50	1 1/2"	10	4,1	59	47,55
620.315.00.1	40 / 50	50	2"	10,4	4,4	60	47,55
620.306.00.1	50	63	2"	11	4,7	74	71,85
620.316.00.1	50 / 65	63	2 1/2"	11,3	4,9	76	71,85
620.307.00.1	65	75	2 1/2"	11,4	5	86	138,15

Livrabil din April 2024

Nou

Adaptoare Geberit FlowFit cu filet exterior, oțel inoxidabil

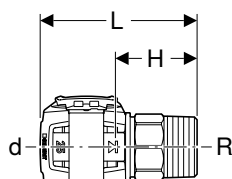

click & scan

Cod art.	DN	d, ø [mm]	R ["]	L [cm]	H [cm]	SW [mm]	EUR/buc.
619.700.00.1	15	20	1/2"	6,4	3,1	22	78,59
619.701.00.1	20	25	3/4"	6,8	3,5	27	97,50
619.702.00.1	25	32	1"	7,5	3,9	34	124,63
619.703.00.1	32	40	1 1/4"	7,4	3,8	47	162,51
619.704.00.1	40	50	1 1/2"	10	4,1	59	211,28
619.705.00.1	50	63	2"	11	4,7	74	270,89
619.706.00.1	65	75	2 1/2"	11,4	5	86	352,15

Livrabil din April 2024

Nou

Adaptor Geberit FlowFit cu file interior

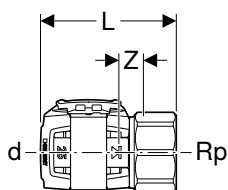

click & scan

Cod art.	DN	d, ø [mm]	Rp ["]	L [cm]	Z [cm]	SW [mm]	EUR/buc.
620.400.00.1	12 / 10	16	3/8"	5,1	1	22	6,63
620.410.00.1	12 / 15	16	1/2"	5,6	1,3	27	6,63
620.420.00.1	12 / 20	16	3/4"	5,8	1,3	32	6,63
620.401.00.1	15 / 10	20	3/8"	5,3	1,2	22	9,14
620.411.00.1	15	20	1/2"	5,5	1,1	27	9,14
620.421.00.1	15 / 20	20	3/4"	5,8	1,3	32	9,14
620.402.00.1	20	25	3/4"	5,7	1,2	32	13,82
620.412.00.1	20 / 25	25	1"	6,1	1,5	41	13,82
620.403.00.1	25	32	1"	6,4	1,4	41	18,23
620.413.00.1	25 / 32	32	1 1/4"	6,7	1,5	47	18,23
620.404.00.1	32 / 25	40	1"	6,4	1,4	47	21,57
620.414.00.1	32	40	1 1/4"	6,7	1,5	47	21,57
620.424.00.1	32 / 40	40	1 1/2"	6,7	1,5	54	21,57
620.405.00.1	40	50	1 1/2"	9,3	1,7	60	47,55
620.415.00.1	40 / 50	50	2"	9,7	1,8	67	47,55
620.406.00.1	50	63	2"	10,2	1,9	75	71,85
620.416.00.1	50 / 65	63	2 1/2"	10,7	1,9	83	71,85
620.407.00.1	65	75	2 1/2"	10,7	2,5	86	138,15

Livrabil din April 2024

Nou

Cot de adaptare 90° Geberit FlowFit, cu file exterior

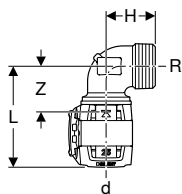

click & scan

Cod art.	DN	d, ø [mm]	R ["]	arc [°]	L [cm]	H [cm]	Z [cm]	EUR/buc.
620.510.00.1	12 / 15	16	1/2"	90	5,7	2,5	2,4	12,17
620.520.00.1	12 / 20	16	3/4"	90	6	3,1	2,7	12,17
620.511.00.1	15	20	1/2"	90	6,1	2,8	2,8	14,92
620.521.00.1	15 / 20	20	3/4"	90	6	2,7	2,7	14,92
620.502.00.1	20	25	3/4"	90	6	2,9	2,7	23,75
620.512.00.1	20 / 25	25	1"	90	6,3	3,2	3	23,75
620.503.00.1	25	32	1"	90	6,8	3,1	3,2	34,01
620.504.00.1	32	40	1 1/4"	90	7,3	4,2	3,7	41,72
620.505.00.1	40	50	1 1/2"	90	10,4	4,7	4,5	60,81
620.506.00.1	50	63	2"	90	11,7	5,8	5,4	127,09

Livrabil din April 2024

Nou

Cot de adaptare 90° Geberit FlowFit, cu filet exterior, lung

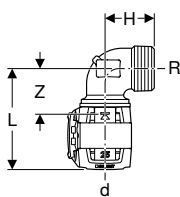

click & scan

Cod art.	DN	d, ø [mm]	R ["]	arc [°]	L [cm]	H [cm]	Z [cm]	EUR/buc.
620.522.00.1	12 / 15	16	1/2"	90	5,7	3,7	2,4	13,39
620.523.00.1	12 / 20	16	3/4"	90	6	4,5	2,7	13,39
620.524.00.1	15	20	1/2"	90	6,1	3,7	2,8	16,41
620.525.00.1	15 / 20	20	3/4"	90	6	4,5	2,7	16,41
620.526.00.1	20	25	3/4"	90	6	4,5	2,7	26,14
620.527.00.1	20 / 25	25	1"	90	6,3	5,6	3	26,14
620.528.00.1	25	32	1"	90	6,8	5,6	3,2	37,49

Livrabil din April 2024

Nou

Cot de adaptare 90° Geberit FlowFit, cu filet interior

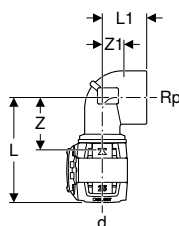

click & scan

Cod art.	DN	d, ø [mm]	Rp ["]	arc [°]	L [cm]	L1 [cm]	Z [cm]	Z1 [cm]	EUR/buc.
620.540.00.1	12 / 15	16	1/2"	90	6,1	2,2	2,8	0,9	12,17
620.550.00.1	12 / 20	16	3/4"	90	6,3	2,5	3	1,2	12,17
620.541.00.1	15	20	1/2"	90	6,1	2,4	2,8	1,1	14,92
620.551.00.1	15 / 20	20	3/4"	90	6,5	2,6	3,2	1,3	14,92
620.532.00.1	20	25	3/4"	90	6,5	2,8	3,2	1,5	23,75
620.542.00.1	20 / 25	25	1"	90	6,9	3	3,6	1,4	23,75
620.533.00.1	25	32	1"	90	7,4	3,4	3,8	1,8	34,01
620.534.00.1	32	40	1 1/4"	90	8,1	3,7	4,5	2,2	41,72
620.535.00.1	40	50	1 1/2"	90	11,2	4,5	5,3	3	60,81
620.536.00.1	50	63	2"	90	12,8	5,3	6,4	3,5	127,09

Livrabil din April 2024

Adaptoare și conexiuni, cu posibilitate de desfacere

Nou

Adaptor Geberit FlowFit cu MasterFix

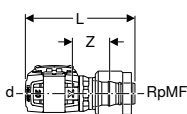

click & scan

Cod art.	DN	d, ø [mm]	RpMF ["]	L [cm]	Z [cm]	EUR/buc.
620.290.00.1	12 / 15	16	1/2"	7,6	2,8	8,34
620.291.00.1	15	20	1/2"	7,6	2,8	10,51

Livrabil din April 2024

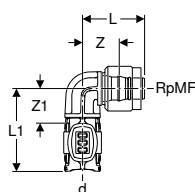
Nou**Cot de adaptare 90° Geberit FlowFit cu MasterFix**

click & scan

Cod art.	DN	d, ø [mm]	RpMF ["]	arc [°]	L [cm]	L1 [cm]	Z [cm]	Z1 [cm]	EUR/buc.
620.490.00.1	12 / 15	16	1/2"	90	4,3	5,8	2,7	2,5	9,65
620.491.00.1	15	20	1/2"	90	4,3	5,8	2,8	2,5	10,51

Livrabil din April 2024

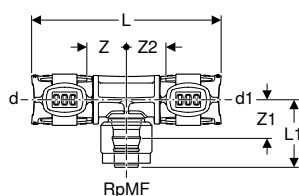
Nou**Teu de adaptare Geberit FlowFit cu MasterFix, trecere**

click & scan

Cod art.	DN	d, ø [mm]	RpMF ["]	d1, ø [mm]	arc [°]	L [cm]	L1 [cm]	Z [cm]	Z1 [cm]	Z2 [cm]	EUR/buc.
620.380.00.1	12 / 15 / 12	16	1/2"	16	90	11,5	4,3	2,5	2,7	2,5	11,91
620.381.00.1	15 / 15 / 12	20	1/2"	16	90	11,5	4,3	2,5	2,8	2,5	14,37
620.391.00.1	15	20	1/2"	20	90	11,5	4,3	2,5	2,8	2,5	14,37
620.382.00.1	20 / 15 / 15	25	1/2"	20	90	11,5	4,1	2,5	2,6	2,5	16,59
620.392.00.1	20 / 15 / 20	25	1/2"	25	90	11,5	4,1	2,5	2,6	2,5	16,59

Livrabil din April 2024

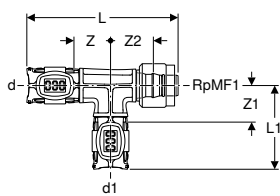
Nou**Teu de adaptare Geberit FlowFit cu MasterFix, ramificație**

click & scan

Cod art.	DN	d, ø [mm]	RpMF1 ["]	d1, ø [mm]	arc [°]	L [cm]	L1 [cm]	Z [cm]	Z1 [cm]	Z2 [cm]	EUR/buc.
620.780.00.1	12 / 12 / 15	16	1/2"	16	90	10,4	5,8	2,5	2,5	3,1	11,91
620.781.00.1	15	20	1/2"	20	90	10,8	6	2,7	2,7	3,3	14,37

Livrabil din April 2024

Nou

Adaptor Geberit FlowFit la Compact

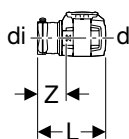

click & scan

Cod art.	DN	d, ø [mm]	di, ø [mm]	L [cm]	Z [cm]	EUR/buc.
620.560.00.1	12	16	21	5,4	2,4	6,92
620.561.00.1	15	20	21	5,4	2,4	8,34
620.562.00.1	20	25	21	5,5	2,4	10,51

Livrabil din April 2024

Nou

Îmbinare filetată Geberit FlowFit

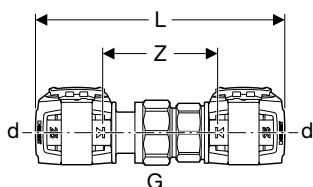

click & scan

Cod art.	DN	d, ø [mm]	G ["]	L [cm]	Z [cm]	SW [mm]	EUR/buc.
620.570.00.1	12	16	1/2"	11,5	5	24	23,50
620.571.00.1	15	20	1/2"	11,7	5,2	24	28,98
620.572.00.1	20	25	3/4"	12,1	5,6	30	35,41
620.573.00.1	25	32	1"	13,9	6,7	38	48,09
620.574.00.1	32	40	1 1/4"	13,9	6,7	46	59,94
620.575.00.1	40	50	1 1/2"	19,1	7,2	55	110,53
620.576.00.1	50	63	2"	20,5	7,8	67	229,32

Livrabil din April 2024

Nou

Îmbinare filetată adaptor Geberit FlowFit cu filet exterior

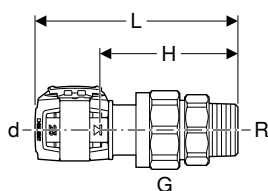

click & scan

Cod art.	DN	d, ø [mm]	R ["]	G ["]	L [cm]	H [cm]	SW [mm]	EUR/buc.
620.580.00.1	12 / 15	16	1/2"	3/4"	8,7	5,4	30	19,36
620.581.00.1	15	20	1/2"	3/4"	9,3	6	30	23,75
620.591.00.1	15 / 20	20	3/4"	1"	9,4	6,1	30	23,75
620.582.00.1	20	25	3/4"	1"	10,2	6,9	38	30,37
620.583.00.1	25	32	1"	1 1/4"	10,5	6,9	46	45,87
620.593.00.1	25 / 32	32	1 1/4"	1 1/2"	10,8	7,2	46	45,87
620.584.00.1	32	40	1 1/4"	1 1/2"	11,3	7,7	55	58,04
620.594.00.1	32 / 40	40	1 1/2"	1 3/4"	11,3	7,7	55	58,04
620.585.00.1	40	50	1 1/2"	1 3/4"	14,9	9	62	110,53
620.595.00.1	40 / 50	50	2"	2 3/4"	14,9	8,9	67	110,53
620.586.00.1	50	63	2"	2 3/4"	15,3	8,9	89	160,27
620.596.00.1	50 / 65	63	2 1/2"	2 3/4"	15,5	9,2	89	160,27

Livrabil din April 2024

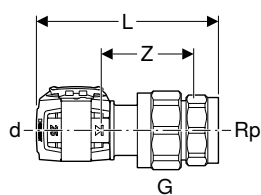
Nou**Îmbinare filetată adaptor Geberit FlowFit cu filet interior**

click & scan

Cod art.	DN	d, ø [mm]	Rp ["]	G ["]	L [cm]	Z [cm]	SW [mm]	EUR/buc.
620.600.00.1	12 / 15	16	1/2"	3/4"	7,9	3,3	30	19,36
620.601.00.1	15	20	1/2"	3/4"	8,5	3,9	30	23,75
620.602.00.1	20	25	3/4"	1"	9,2	4,4	38	30,37
620.603.00.1	25	32	1"	1 1/4"	9,4	4,1	46	45,87
620.613.00.1	25 / 32	32	1 1/4"	1 1/4"	10,6	5,1	46	45,87
620.604.00.1	32	40	1 1/4"	1 1/2"	10,9	5,4	55	58,04
620.614.00.1	32	40	1 1/2"	1 1/2"	11,2	5,6	55	58,04
620.605.00.1	40	50	1 1/2"	1 1/2"	13,8	5,9	55	110,53
620.615.00.1	40 / 50	50	2"	2"	14,9	6,6	67	110,53
620.606.00.1	50	63	2"	2 3/4"	13,3	4,3	89	160,27

Livrabil din April 2024



Nou

Adaptor Geberit FlowFit cu piuliță olandeză

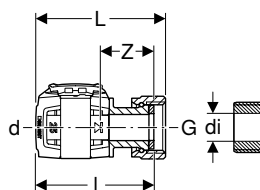

click & scan

Cod art.	DN	d, ø [mm]	G ["]	di, ø [mm]	L [cm]	l [cm]	Z [cm]	SW [mm]	EUR/buc.
620.620.00.1	12	16	3/8"	9	6,2	5,5	2,2	20	13,82
620.630.00.1	12 / 15	16	1/2"	11	6,4	5,7	2,4	24	13,82
620.640.00.1	12 / 20	16	3/4"	17	5,9	5,2	1,9	30	13,82
620.650.00.1	12 / 25	16	1"	21	6,2	5,4	2,1	38	13,82
620.621.00.1	15 / 12	20	3/8"	9	6,2	5,5	2,2	20	16,03
620.631.00.1	15	20	1/2"	11	6,4	5,7	2,4	24	16,03
620.641.00.1	15 / 20	20	3/4"	16	6,5	5,8	2,5	30	16,03
620.651.00.1	15 / 25	20	1"	21	6,3	5,5	2,2	38	16,03
620.672.00.1	15 / 30	20	1 1/8"	23	6,4	5,5	2,2	41	17,10
620.661.00.1	15 / 32	20	1 1/4"	27	6,6	5,6	2,3	46	17,10
620.671.00.1	15 / 40	20	1 1/2"	32	6,2	5	1,7	55	17,10
620.622.00.1	20 / 15	25	1/2"	11	6,4	5,7	2,4	24	20,18
620.632.00.1	20	25	3/4"	15	6,5	5,8	2,5	30	20,18
620.642.00.1	20 / 25	25	1"	20	7,3	6,3	3	38	20,18
620.652.00.1	20 / 32	25	1 1/4"	27	6,8	5,8	2,5	46	21,57
620.662.00.1	20 / 40	25	1 1/2"	32	7,1	5,9	2,6	55	21,57
620.673.00.1	20 / 50	25	2"	42	6,3	5	1,7	67	33,14
620.623.00.1	25 / 20	32	3/4"	16	7	6,3	2,7	30	28,76
620.633.00.1	25	32	1"	20	7,8	6,8	3,2	38	28,76
620.643.00.1	25 / 32	32	1 1/4"	27	7,4	6,4	2,8	46	33,14
620.653.00.1	25 / 40	32	1 1/2"	32	7,6	6,4	2,8	55	33,14
620.663.00.1	25 / 50	32	2"	42	7,5	6,2	2,6	67	44,18
620.674.00.1	32 / 25	40	1"	20	7,8	6,8	3,2	38	44,18
620.624.00.1	32	40	1 1/4"	27	7,9	6,9	3,3	46	41,97
620.634.00.1	32	40	1 1/2"	33	8	6,9	3,3	55	41,97
620.664.00.1	32 / 40	40	1 3/4"	33	8,9	7,6	4	62	41,97
620.644.00.1	32 / 50	40	2"	42	7,8	6,5	2,9	67	53,03
620.654.00.1	32 / 65	40	2 1/4"	42	7,7	6,3	2,7	74	53,03
620.625.00.1	40	50	1 1/2"	33	10,6	9,5	3,6	55	59,12
620.635.00.1	40	50	1 3/4"	33	11,5	10,2	4,3	62	59,12
620.645.00.1	40 / 50	50	2"	42	11	9,9	3,9	67	70,21
620.655.00.1	40 / 50	50	2 1/4"	42	10,8	9,4	3,5	74	70,21
620.665.00.1	40 / 50	50	2 3/8"	52	10,9	9,4	3,5	78	70,21
620.695.00.1	40 / 65	50	2 1/2"	54	10,9	9,7	3,8	83	70,21
620.675.00.1	40 / 65	50	2 3/4"	62	10,7	9,1	3,2	89	70,21
620.626.00.1	50 / 50	63	2"	42	11,5	10,4	4	67	92,82
620.636.00.1	50 / 50	63	2 3/8"	52	11,6	10,5	4,1	78	92,82
620.646.00.1	50 / 65	63	2 1/2"	54	11,8	10,2	3,9	83	92,82
620.656.00.1	50 / 65	63	2 3/4"	62	11,5	9,9	3,6	89	92,82

Livrabil din April 2024

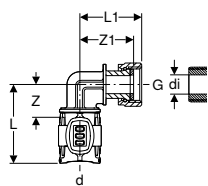
Nou**Cot de adaptare 90° Geberit FlowFit, cu piuliță**

click & scan

Cod art.	DN	d, ø [mm]	G ["]	di, ø [mm]	L [cm]	L1 [cm]	Z [cm]	Z1 [cm]	SW [mm]	EUR/buc.
620.685.00.1	12	16	3/8"	9	5,4	3,7	3,6	3,1	22	17,78
620.686.00.1	12 / 15	16	1/2"	11	5,6	4	3,6	3,3	24	17,78
620.688.00.1	15	20	1/2"	11	5,6	4,2	3,5	3,5	24	20,71
620.689.00.1	15 / 20	20	3/4"	16	5,8	3,2	3,5	3,6	30	20,71
620.693.00.1	20	25	3/4"	15	5,9	4,5	3,5	3,8	30	26,10
620.694.00.1	20 / 25	25	1"	20	6,3	5,2	3,5	4,3	38	26,10

Livrabil din April 2024

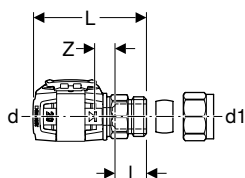
Nou**Adaptor Geberit FlowFit cu fitting de compresie**

click & scan

Cod art.	DN	d, ø [mm]	d1, ø [mm]	L [cm]	I [cm]	Z [cm]	EUR/buc.
620.680.00.1	12 / 10	16	12	5,8	1,7	0,8	14,92
620.683.00.1	12 / 10	16	14	5,8	1,7	0,8	18,82
620.690.00.1	12	16	15	5,8	1,6	0,9	14,92
620.691.00.1	12	16	16	5,8	1,6	0,9	18,82
620.681.00.1	15 / 12	20	15	6	1,6	1,1	17,10
620.684.00.1	15	20	18	6	1,6	1,1	21,57

Livrabil din April 2024

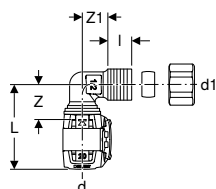
Nou**Cot de adaptare Geberit FlowFit 90° cu fitting de compresie**

click & scan

Cod art.	DN	d, ø [mm]	d1, ø [mm]	arc [°]	L [cm]	I [cm]	Z [cm]	Z1 [cm]	SW [mm]	EUR/buc.
620.700.00.1	12 / 10	16	12	90	5,5	0,8	2,2	1,7	24	18,82
620.710.00.1	12	16	15	90	5,5	0,8	2,2	1,7	24	18,82
620.701.00.1	15 / 12	20	15	90	5,7	0,8	2,4	1,7	24	21,57

Livrabil din April 2024

Nou

Adaptor Geberit FlowFit la fitting de compresie pentru țevă din cupru

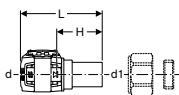

click & scan
EUR/buc.

Cod art.	DN	d, ø [mm]	d1, ø [mm]	L [cm]	H [cm]	EUR/buc.
620.720.00.1	12	16	15	7	3,7	16,59
620.721.00.1	15 / 12	20	15	7	3,7	18,82
620.722.00.1	20	25	22	7,4	4,1	23,21

Livrabil din April 2024



- Potrivit exclusiv pentru fittinguri de compresie

Nou

Adaptor Geberit FlowFit cu îmbinare filetată pentru țevi PEX

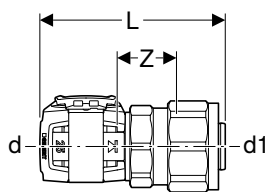

click & scan

Cod art.	DN	d, ø [mm]	G ["]	d1, ø [mm]	s1 [mm]	L [cm]	Z [cm]	PN [bar]	EUR/buc.
620.730.00.1	12	16	3/4"	16	1,5	7,8	3,1	6	19,36
620.731.00.1	15	20	3/4"	20	1,9	7,8	3,1	6	22,11
620.732.00.1	20	25	1"	25	2,3	8	3,3	6	24,90

Livrabil din April 2024

Nou

Flanșă Geberit FlowFit PN6, cu unitate de presare

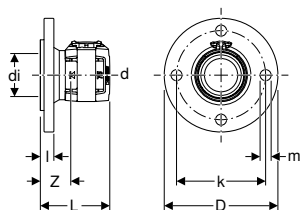

click & scan

Cod art.	DN	d, ø [mm]	di, ø [mm]	D [cm]	k [mm]	m [mm]	L [cm]	l [cm]	Z [cm]	n [pc.]	PN [bar]	EUR/buc.
619.616.00.1	65	75	70	16	130	14	11,3	2,4	5	4	6	165,79

Livrabil din April 2024

Nou

Flanșă Geberit FlowFit PN10/16, cu unitate de presare

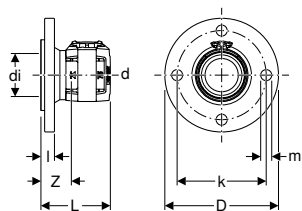

click & scan

Cod art.	DN	d, ø [mm]	di, ø [mm]	D [cm]	k [mm]	m [mm]	L [cm]	l [cm]	Z [cm]	n [pc.]	PN [bar]	EUR/buc.
619.617.00.1	65	75	70	18,5	145	18	11,3	2,4	5	4	10 / 16	165,79

Livrabil din April 2024

Închizători

Nou

Dop de capăt țevă Geberit FlowFit

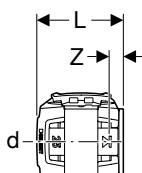

click & scan

Cod art.	DN	d, ø [mm]	L [cm]	Z [cm]	EUR/buc.
620.740.00.1	12	16	3,9	0,6	4,68
620.741.00.1	15	20	3,9	0,6	5,28
620.742.00.1	20	25	3,9	0,6	5,79

Livrabil din April 2024



Racorduri

Cot de racordare Geberit FlowFit 90°

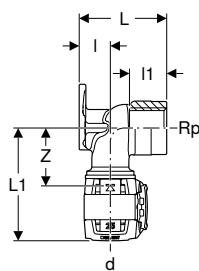

click & scan

Cod art.	DN	d, ø [mm]	Rp ["]	arc [°]	L1 [cm]	l [cm]	l1 [cm]	Z [cm]	EUR/buc.	
L / lungime: 3,6 cm										
620.750.00.1	N	12	16	3/8"	90	6	1,9	1,3	2,7	11,33
620.760.00.1	N	12	16	1/2"	90	6	1,9	1,3	2,8	11,33
620.751.00.1	N	15	20	3/8"	90	6	1,9	1,3	2,7	11,91
620.761.00.1	N	15	20	1/2"	90	6,3	1,9	1,3	3,1	11,91
L / lungime: 5,2 cm										
620.800.00.1	N	12	16	3/8"	90	6	1,9	1,5	2,7	12,42
620.810.00.1		12	16	1/2"	90	6	1,9	1,5	2,7	12,42
620.801.00.1	N	15	20	3/8"	90	6	1,9	1,5	2,7	12,97
620.811.00.1		15	20	1/2"	90	6	1,9	1,7	3,1	12,97
620.821.00.1	N	15	20	3/4"	90	6,3	1,9	1,9	3	15,50
620.802.00.1		20	25	3/4"	90	6,7	1,9	1,9	3,4	22,11
L / lungime: 7,8 cm										
620.770.00.1	N	12	16	1/2"	90	6,8	1,9	3	3,5	17,10
620.771.00.1	N	15	20	1/2"	90	7,3	1,9	3	4	21,00

N: Nou, livrabil din April 2024

De comandat suplimentar

- Suport fonoizolant Geberit pentru cot de conectare 90° simplu → p. 152

Accesorii

- Set fonoizolant Geberit pentru cot de conectare 90° simplu → p. 152

Nou

Cot dublu de racordare Geberit FlowFit 90°

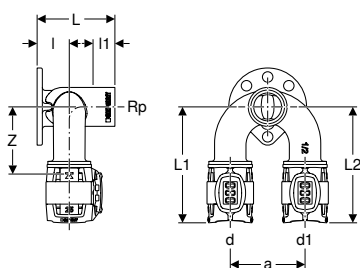

click & scan

Cod art.	DN	d, ø [mm]	Rp ["]	d1, ø [mm]	arc [°]	a [cm]	L1 [cm]	L2 [cm]	l [cm]	l1 [cm]	Z [cm]	EUR/buc.
L / lungime: 5,2 cm												
620.830.00.1	12 / 15 / 12	16	1/2"	16	90	5	7,1	7,1	1,9	2,4	3,8	30,13
620.831.00.1	12 / 15 / 15	16	1/2"	20	90	5	7,1	7,1	1,9	2,4	3,8	35,65
620.841.00.1	15 / 15 / 12	20	1/2"	16	90	5	7,1	7,1	1,9	2,4	3,8	35,65
620.851.00.1	15	20	1/2"	20	90	5	7,6	7,6	1,9	2,4	4,3	35,65
620.832.00.1	15 / 15 / 20	20	1/2"	25	90	5	7,6	7,8	2,2	2,4	4,3	41,17
620.842.00.1	20 / 15 / 15	25	1/2"	20	90	5	7,8	7,6	2,2	2,4	4,3	41,17
620.852.00.1	20 / 15 / 20	25	1/2"	25	90	5	7,3	7,3	2,2	2,4	4,3	41,17

Livrabil din April 2024

Nou

Cot T de racordare Geberit FlowFit 90° decalat

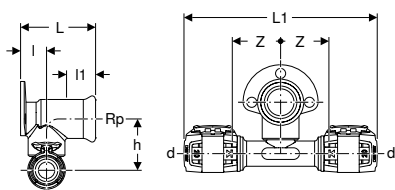

click & scan

Cod art.	DN	d, ø [mm]	Rp ["]	d1, ø [mm]	arc [°]	L1 [cm]	l [cm]	l1 [cm]	h [cm]	Z [cm]	EUR/buc.
L / lungime: 3,6 cm											
620.951.00.1	15	20	1/2"	20	90	13,4	1,8	1,5	3,6	3,4	20,47
L / lungime: 5,2 cm											
620.981.00.1	15	20	1/2"	20	90	13,4	1,8	2,9	3,6	3,4	20,47

Livrabil din April 2024

Accesorii

- Suport fonoizolant Geberit pentru conectare drept → p. 152

Nou

Cot de racordare la colț Geberit FlowFit 90°

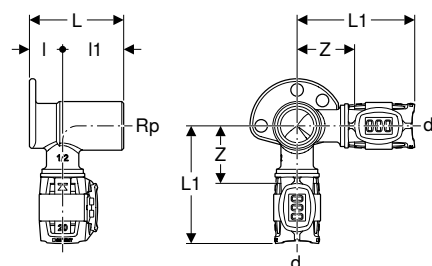

click & scan

Cod art.	DN	d, ø [mm]	Rp ["]	arc [°]	L1 [cm]	l [cm]	l1 [cm]	Z [cm]	EUR/buc.
L / lungime: 3,6 cm									
620.881.00.1	15	20	1/2"	90	6,6	1,9	1,8	3,3	20,47
L / lungime: 5,2 cm									
620.921.00.1	15	20	1/2"	90	6,6	1,9	3,4	3,3	20,47

Livrabil din April 2024

Accesorii

- Suport fonoizolant Geberit pentru conectare drept → p. 152

Set cot de racordare Geberit, 90°, cu filet exterior MF 1/2"

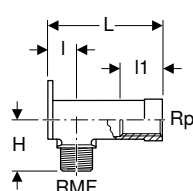

click & scan

Cod art.	DN	RMF ["]	Rp ["]	arc [°]	l [cm]	l1 [cm]	H [cm]	EUR/buc.
L / lungime: 7,3 cm								
465.034.00.2	15	1/2"	1/2"	90	1,8	3	3,5	22,83

Distribuator cu racord filetat

Nou

Adaptor Geberit FlowFit cu MasterFix

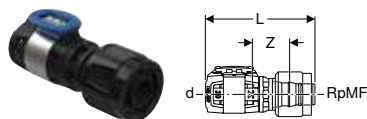

click & scan
EUR/buc.

Cod art.	DN	d, ø [mm]	RpMF ["]	L [cm]	Z [cm]	EUR/buc.
620.290.00.1	12 / 15	16	1/2"	7,6	2,8	8,34
620.291.00.1	15	20	1/2"	7,6	2,8	10,51

Livrabil din April 2024

Nou

Derivație Geberit FlowFit pentru eurocon

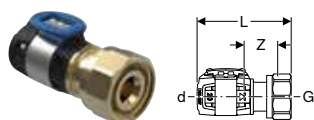

click & scan
EUR/buc.

Cod art.	DN	d, ø [mm]	G ["]	L [cm]	Z [cm]	SW [mm]	EUR/buc.
620.330.00.1	12 / 20	16	3/4"	6,1	2,6	27	12,20
620.331.00.1	15 / 20	20	3/4"	6,5	3,1	27	14,37

Livrabil din January 2024

Adaptoare și conexiuni pentru instalație de încălzire, cu posibilitate de desfacere

Nou

Adaptor Geberit FlowFit cu îmbinare filetată pentru țevi PEX

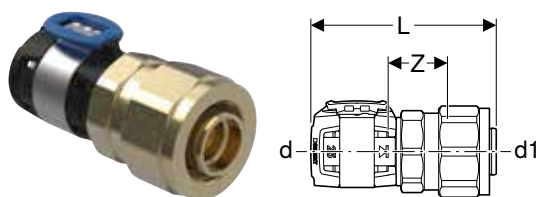

click & scan

Cod art.	DN	d, ø [mm]	G ["]	d1, ø [mm]	s1 [mm]	L [cm]	Z [cm]	PN [bar]	EUR/buc.
620.730.00.1	12	16	3/4"	16	1,5	7,8	3,1	6	19,36
620.731.00.1	15	20	3/4"	20	1,9	7,8	3,1	6	22,11
620.732.00.1	20	25	1"	25	2,3	8	3,3	6	24,90

Livrabil din April 2024

Racorduri pentru încălzire

Nou

Racord Geberit FlowFit drept, piuliță

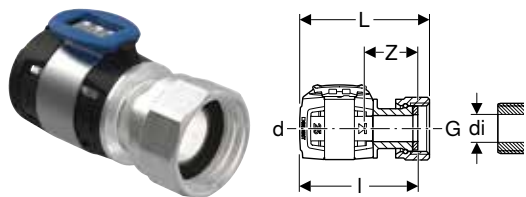

click & scan

Cod art.	DN	d, ø [mm]	G ["]	di, ø [mm]	L [cm]	l [cm]	Z [cm]	SW [mm]	EUR/buc.
619.490.22.1	12	16	1/2"	11	6,4	5,7	2,4	24	14,68
619.491.22.1	15	20	1/2"	11,4	6,4	5,7	2,4	24	16,85
619.492.22.1	20	25	3/4"	14,8	6,5	5,8	2,5	30	21,29

Livrabil din April 2024

Nou

Racord Geberit FlowFit pentru eurocon, cu piuliță

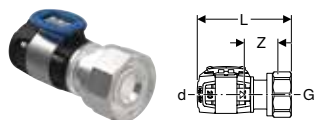

click & scan

EUR/buc.

Cod art.	DN	d, ø [mm]	G ["]	L [cm]	Z [cm]	SW [mm]	EUR/buc.
619.260.22.1	12 / 20	16	3/4"	6,1	1,8	27	10,82
619.261.22.1	15 / 20	20	3/4"	6,5	2,3	27	13,02

Livrabil din April 2024

Nou

Racord Geberit FlowFit drept, cu filet exterior

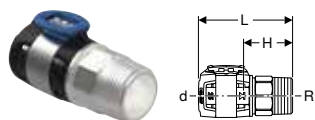

click & scan

EUR/buc.

Cod art.	DN	d, ø [mm]	R ["]	L [cm]	H [cm]	SW [mm]	EUR/buc.
619.471.22.1	15	20	1/2"	6,4	3,1	22	9,74
619.481.22.1	15 / 20	20	3/4"	6,5	3,2	27	9,74
619.472.22.1	20 / 15	25	1/2"	6,4	3,1	22	12,20
619.482.22.1	20	25	3/4"	6,8	3,5	27	12,20

Livrabil din April 2024



Accesorii

Izolații pentru racorduri

Set fonoizolant Geberit pentru cot de conectare 90° simplu

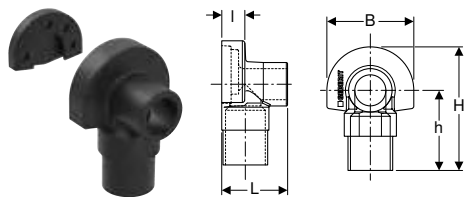

click & scan

Cod art.	L [cm]	I [cm]	B [cm]	H [cm]	h [cm]	EUR/buc.
601.801.00.1	5,3	1,9	7	10	6,5	3,03

Suport fonoizolant Geberit pentru conectare drept



click & scan

Cod art.	EUR/buc.
601.802.00.1	1,36

Suport fonoizolant Geberit pentru cot de conectare 90° simplu

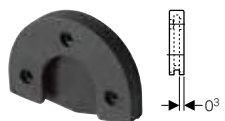

click & scan

Cod art.	EUR/buc.
601.806.00.1	2,67

Etanșări pentru țevi și fittinguri

Bandă de etanșare Geberit

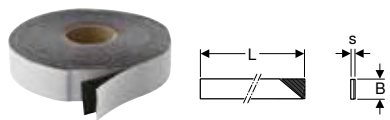

click & scan

Cod art.	s [mm]	L [m]	B [cm]	EUR/buc.
601.813.00.1	1	12,5	3	31,41
601.815.00.1	1	12,5	5	52,06



- Montare după încercare la presiune

Garnituri pentru fittinguri

Nou

Manson de etansare Geberit FlowFit

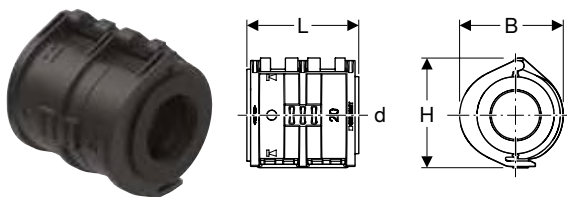

click & scan

Cod art.	d, \emptyset [mm]	L [cm]	B [cm]	H [cm]	EUR/buc.
619.720.00.1	16	4,5	3,8	3,9	6,66
619.721.00.1	20	4,5	4,2	4,2	7,10
619.722.00.1	25	4,5	4,7	4,8	7,76

Livrabil din April 2024

Dispozitive de fixare pentru țevi

Nou

Set de montaj în punct fix Geberit

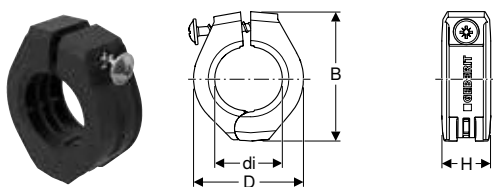

click & scan

Cod art.	di, \emptyset [mm]	D [cm]	B [cm]	H [cm]	EUR/buc.
619.730.00.1	16	3,1	4	1,9	7,83
619.731.00.1	20	3,5	4,4	1,9	8,87
619.732.00.1	25	4	4,9	1,9	9,89
619.733.00.1	32	4,7	5,6	1,9	11,47
619.734.00.1	40	5,6	6,5	1,9	13,57
619.735.00.1	50	6,6	7,8	2,2	16,41
619.736.00.1	63	8	9,1	2,2	20,84
619.737.00.1	75	9,2	10,3	2,2	28,13

Livrabil din April 2024

Brățară pentru conductă Geberit, izolată, cu piuliță conector M8 / M10

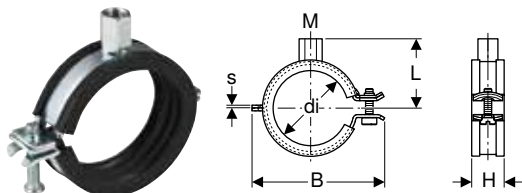

click & scan

Cod art.	Culoare/suprafață	M [mm]	di, \emptyset [mm]	s [mm]	L [cm]	B [cm]	H [cm]	EUR/buc.
601.851.26.1	Galvanizat	8 / 10	15-19	1,5	3,1	5,2	2,3	1,75
601.852.26.1	Galvanizat	8 / 10	20-24	1,5	3,4	5,6	2,3	1,75
601.853.26.1	Galvanizat	8 / 10	25-30	1,5	3,6	6,3	2,3	1,86
601.854.26.1	Galvanizat	8 / 10	32-37	1,5	3,9	6,8	2,3	2,00
601.855.26.1	Galvanizat	8 / 10	40-46	2	4,3	7,6	2,3	2,12
601.856.26.1	Galvanizat	8 / 10	48-53	2	4,5	8,2	2,3	2,23
601.858.26.1	Galvanizat	8 / 10	63-67	2	5,5	10	2,3	3,34
601.859.26.1	Galvanizat	8 / 10	74-80	2	6,4	11,9	2,3	3,61

Cochilie suport Geberit, galvanizată și vopsită

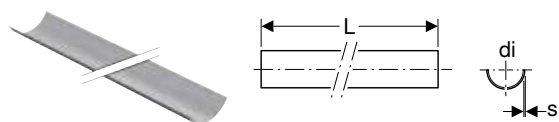

click & scan
 EUR/m

Cod art.	Culoare/suprafață	DN	di, \varnothing [mm]	s [mm]	L [m]	
360.850.00.1	Vopsit	40	40	0,75	3	4,68
361.850.00.1	Vopsit	50	50	0,75	3	4,68
364.850.00.1	Vopsit	60	63	0,75	3	5,32
365.850.00.1	Vopsit	70	75	0,75	3	5,69

Niplu dublu Geberit M10 / G 1/2"

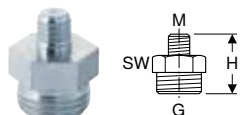

click & scan
 EUR/buc.

Cod art.	Culoare/suprafață	G ["]	M [mm]	H [cm]	SW [mm]	
362.856.26.1	Galvanizat	1/2"	10	2,8	22	5,60

Țeavă filetată Geberit

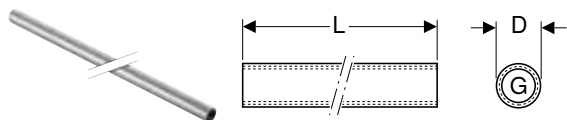

click & scan
 EUR/buc.

Cod art.	G ["]	D [cm]	L [cm]	
362.857.26.1	1/2"	2,5	115	38,24

Placă de fixare Geberit dreptunghiulară, două orificii, cu piuliță conector M8/M10

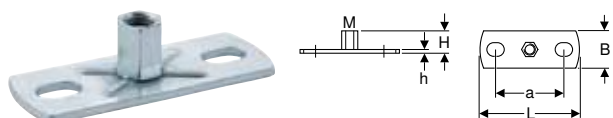

click & scan
 EUR/buc.

Cod art.	M [mm]	a [cm]	L [cm]	B [cm]	H [cm]	h [cm]	
362.848.26.1	8 / 10	5,4	8	3	1,9	0,3	3,81

Placă de fixare Geberit dreptunghiulară, două orificii, cu piuliță conector M10/G 1/2"

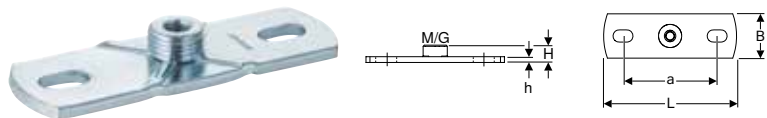

click & scan
 EUR/buc.

Cod art.	G ["]	M [mm]	a [cm]	L [cm]	B [cm]	H [cm]	h [cm]	
362.851.26.1	1/2"	10	8,5	12	4	1,5	0,5	4,68

Dispozitive de fixare pentru racorduri

Placă de montaj Geberit, dreaptă, simplă

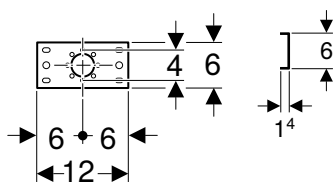

click & scan

Cod art.	EUR/buc.
601.736.00.1	5,69

Placă de montaj Geberit, dreaptă, dublă, distanță de racordare 10 cm sau 12 cm

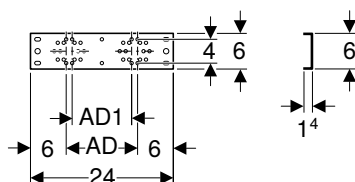

click & scan

Cod art.	AD [cm]	AD1 [cm]	EUR/buc.
601.738.00.1	12	10	7,17

Accesorii

- Brățară pentru conductă de evacuare Geberit pentru plăci de montaj → p. 156

Placă de montaj Geberit, dreaptă, dublă, distanță de racordare 7,3 cm sau 15,3 cm

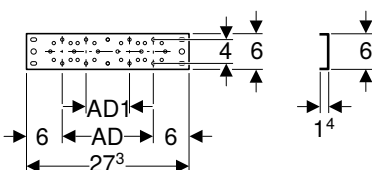

click & scan

Cod art.	AD [cm]	AD1 [cm]	EUR/buc.
601.737.00.1	15,3	7,3	7,17

Accesorii

- Brățară pentru conductă de evacuare Geberit pentru plăci de montaj → p. 156

Placă de montaj Geberit, cu decalaj, simplă, pentru sistemul de alimentare

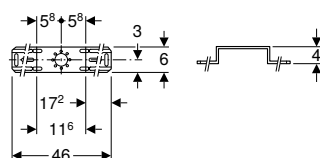

click & scan

Cod art.	EUR/buc.
601.733.00.1	5,69

Placă de montaj Geberit, montată, dublă, distanță de racordare 10 cm sau 12 cm



click & scan

Cod art.	AD [cm]	AD1 [cm]	EUR/buc.
601.731.00.1	12	10	7,17

Accesorii

- Brățară pentru conductă de evacuare Geberit pentru plăci de montaj → p. 156

Placă de montaj Geberit, montată, dublă, distanță de racordare 7,3 cm sau 15,3 cm

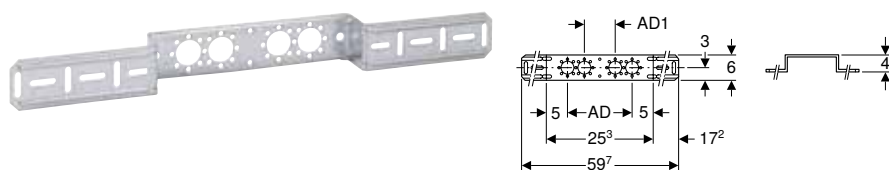

click & scan

Cod art.	AD [cm]	AD1 [cm]	EUR/buc.
601.732.00.1	15,3	7,3	7,17

Accesorii

- Brățară pentru conductă de evacuare Geberit pentru plăci de montaj → p. 156

Brățară pentru conductă de evacuare Geberit pentru plăci de montaj

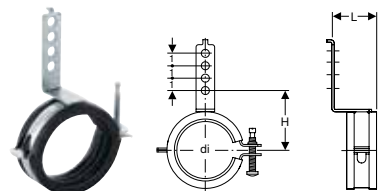

click & scan

Cod art.	Culoare/suprafață	di, ø [mm]	L [cm]	H [cm]	EUR/buc.
601.741.00.1	Galvanizat	50-56	3,6	5,2-5,5	5,56

Etanșări sistem

Nou

Garnitură flanșă Geberit PN 10/16, din fibre compozite



click & scan
EUR/buc.

Cod art.	DN	da [mm]	di, Ø [mm]	s [mm]	PN [bar]	
600.041.00.1	15	50	20	2	10 / 16	1,89
600.042.00.1	20	60	25	2	10 / 16	2,11
600.043.00.1	25	70	30	2	10 / 16	2,51
600.044.00.1	32	82	38	2	10 / 16	2,98
600.045.00.1	40	92	45	2	10 / 16	3,55
600.046.00.1	50	107	57	2	10 / 16	4,22
600.047.00.1	65	127	76	2	10 / 16	5,28
600.048.00.1	80	142	89	2	10 / 16	6,34
600.049.00.1	100	162	108	2	10 / 16	7,61

Livrabil din April 2024



- Produs înlocuitor pentru cod art. 91031, 91032, 91033, 91034, 91035, 91036, 91037, 91038, 91039

Nou

Garnitură flanșă Geberit PN 6, din fibre compozite



click & scan
EUR/buc.

Cod art.	DN	da [mm]	di, Ø [mm]	s [mm]	PN [bar]	
600.051.00.1	15	44	20	2	6	1,67
600.052.00.1	20	54	25	2	6	1,87
600.053.00.1	25	64	30	2	6	2,22
600.054.00.1	32	76	38	2	6	2,64
600.055.00.1	40	86	45	2	6	3,15
600.056.00.1	50	96	57	2	6	3,73
600.057.00.1	65	116	76	2	6	4,68
600.058.00.1	80	132	89	2	6	5,61
600.059.00.1	100	152	108	2	6	6,72

Livrabil din April 2024



- Produs înlocuitor pentru cod art. 91041, 91042, 91043, 91044, 91045, 91046, 91047, 91048, 91049

Seturi șuruburi pentru conexiuni cu flanșă

Set șurub Geberit pentru conexiune cu flanșă, din oțel galvanizat

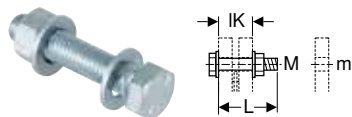

click & scan
EUR/buc.

Cod art.	M [mm]	m [mm]	L [cm]	IK [cm]	
91064	10	11	4,5	3,1	2,01
91065	10	11	5	3,6	2,01
91066	12	14	5	3	2,16
91067	12	14	5,5	3,5	2,16
91068	12	14	6	4	2,16
91069	16	18	5,5	3,3	3,93
91070	16	18	6	3,8	3,93
91071	16	18	6,5	4,3	3,93
91072	16	18	7	4,8	3,93
91073	16	18	8	5,8	3,93

Set șurub Geberit pentru conexiune cu flanșă, din oțel CrNi

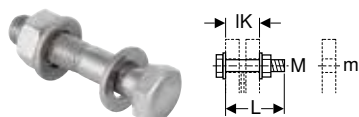

click & scan
EUR/buc.

Cod art.	M [mm]	m [mm]	L [cm]	IK [cm]	
91164	10	11	4,5	3,1	4,80
91165	10	11	5	3,6	4,80
91166	12	14	5	3	6,32
91167	12	14	5,5	3,5	6,32
91168	12	14	6	4	6,32
91169	16	18	5,5	3,3	9,45
91170	16	18	6	3,8	9,45
91171	16	18	6,5	4,3	9,45
91172	16	18	7	4,8	9,45
91173	16	18	8	5,8	9,45

Material de consum

Nou

Spray de detectare a scurgerilor Geberit



click & scan

Cod art.	Conținut [ml]	EUR/buc.
690.942.00.1	400	13,04

Livrabil din April 2024





Încălzire și răcire radiantă

Țevi	162
Material de pozare	162
Plăci cu nuturi	162
Benzi perimetrare.....	163
Benzi autocolante	163
Clipsuri de fixare	163
Aditivi de pardoseală	164
Rosturi de extindere.....	164
Curbe conducătoare	164
Dulapuri de distribuție.....	165
Dulapuri de distribuție din metal	165
Gamă de distribuitoare.....	166
Distribuitoare pentru încălzire prin pardoseală.....	166
Robinet de închidere cu bilă	166
Termometre.....	167
Adaptoare.....	167
Elemente de închidere pentru distribuitoare	168
Divizoare de debit	168
Unități de reglare a temperaturii	169
Distribuitoare pentru circuitele corpurilor de încălzire.....	169
Bypassuri	170
Componente de reglaj.....	170
Servomotoare.....	170
Termostate de ambianță	171
Regulator principal	172
Module de comunicare	172
Senzori.....	172
Transformatoare	173
Accesorii.....	173
Izolații pentru distribuitoare	173



Țevi

Țeavă monostrat Geberit SL cu EVOH, NPW, la colac

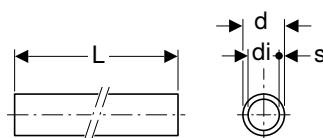

click & scan

Cod art.	DN	d, \varnothing [mm]	di, \varnothing [mm]	s [mm]	L [m]	EUR/m
617.170.00.1	12	16	12	2	120	1,25
617.180.00.1	12	16	12	2	240	1,25
617.190.00.1	12	16	12	2	600	1,25
617.171.00.1	15	20	16	2	120	2,09
617.181.00.1	15	20	16	2	240	2,09

Nou

Țeavă multistrat Geberit, ML, Therm, la colac

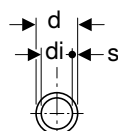

click & scan

Cod art.	DN	d, \varnothing [mm]	di, \varnothing [mm]	s [mm]	L [m]	EUR/m
619.130.00.1	12	16	12	2	120	2,33
619.131.00.1	12	16	12	2	250	1,89
619.133.00.1	15	20	16	2	100	3,00
619.135.00.2	20	25	20	2,5	50	5,52

Livrabil din April 2024

Accesorii

- Foarfecă Geberit → p. 311
- Aparat Geberit de tăiat țevi ML → p. 310
- Instrument de calibrare Geberit FlowFit → p. 310

Material de pozare

Plăci cu nuturi

Etrier de susținere Geberit



Cod art.
651.827.00.1



click & scan
EUR/buc.

0,25

Placă cu nuturi Geberit

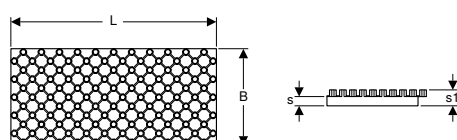

click & scan

Date tehnice

Material de izolație	EPS
Conductibilitate termică a izolației	0,035 W/(m·K)

Caracteristici

- Cu țeavă Geberit \varnothing 16 mm, cu posibilitate de echipare
- Folie de protecție din PS

Cod art.	s1 [mm]	s [mm]	L [cm]	B [cm]	EUR/m ²
651.822.00.1	30	10	138	69	25,32

Benzi perimetrare

Bandă perimetrală Geberit

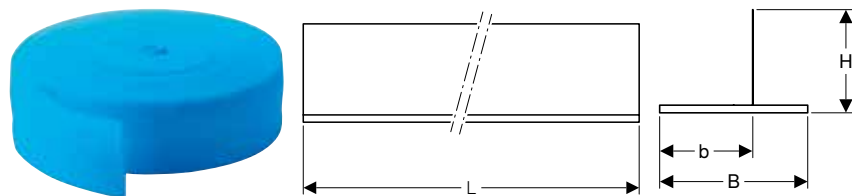

click & scan

Cod art.	L [m]	B [cm]	b [cm]	H [cm]	EUR/m
651.810.00.1	25	15	10	25,8	1,60

Benzi autocolante

Bandă adezivă Geberit

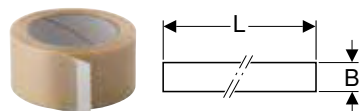

click & scan

Cod art.	L [m]	B [cm]	EUR/buc.
651.811.00.1	66	5	9,36

Clipsuri de fixare

Clips de fixare Geberit



click & scan

Cod art.	di, ø [mm]	EUR/buc.
651.761.00.1	16 / 20	0,20

Dispozitiv pentru agrafe de fixare Geberit



click & scan

Cod art.	EUR/buc.
690.800.00.1	326,39

Aditivi de pardoseală

Aditiv de pardoseală Geberit



click & scan

Cod art.	Conținut [ml]	EUR/l
651.812.00.1	10000	5,72

Rosturi de extindere

Profil de rost de dilatație Geberit

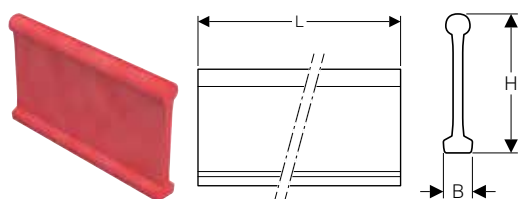

click & scan

Cod art.	L [m]	B [cm]	H [cm]	EUR/m
651.824.00.1	2	2,4	9	12,66

Curbe conducătoare

Suport cot de țevă Geberit

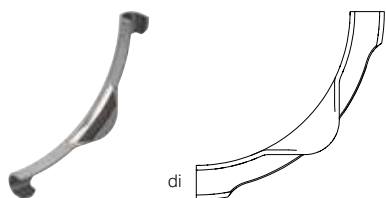

click & scan

Cod art.	di, ø [mm]	EUR/buc.
651.828.00.1	16	2,89
651.829.00.1	20	2,89

Dulapuri de distribuție

Dulapuri de distribuție din metal

Dulap de distribuție Geberit

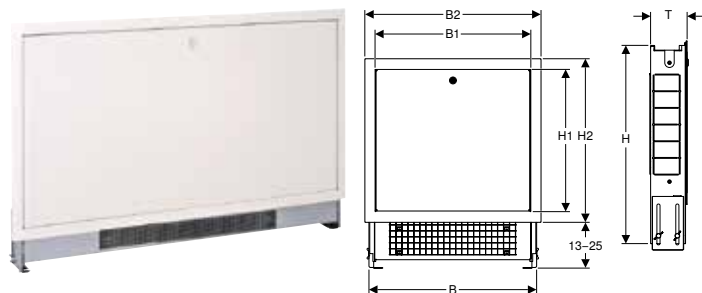

click & scan

Cod art.	B [cm]	B1 [cm]	B2 [cm]	H [cm]	H1 [cm]	H2 [cm]	T [cm]	EUR/buc.
652.476.00.1	50	49	56	63	45	52	8-9	118,58
652.477.00.1	70	69	76	63	45	52	8-9	146,62
652.478.00.1	85	84	91	63	45	52	8-9	174,68
652.479.00.1	100	99	106	63	45	52	8-9	202,70
652.480.00.1	120	119	126	63	45	52	8-9	230,74
652.470.00.1	50	49	56	63	45	52	11-15	127,13
652.471.00.1	70	69	76	63	45	52	11-15	155,22
652.472.00.1	85	84	91	63	45	52	11-15	183,28
652.473.00.1	100	99	106	63	45	52	11-15	211,30
652.474.00.1	120	119	126	63	45	52	11-15	239,39

Accesorii

- Set șine de fixare Geberit → p. 165

Set șine de fixare Geberit



click & scan

Cod art.	EUR/buc.
652.481.00.1	26,67

Gamă de distribuitoare

Distribuitoare pentru încălzire prin pardoseală

Distribuitor Geberit pentru încălzire prin pardoseală

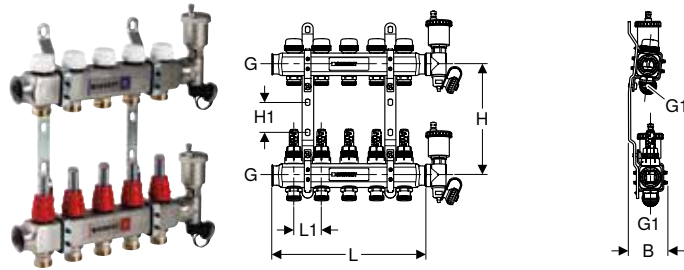

click & scan

Cod art.	DN	G [„]	G1 [„]	L [cm]	L1 [cm]	B [cm]	H [cm]	H1 [cm]	Număr de ieșiri	EUR/buc.
652.520.00.1	25 / 15 / 25	1"	3/4"	13	5	8	20	5	2	134,65
652.521.00.1	25 / 15 / 25	1"	3/4"	18	5	8	20	5	3	168,30
652.522.00.1	25 / 15 / 25	1"	3/4"	23	5	8	20	5	4	201,95
652.523.00.1	25 / 15 / 25	1"	3/4"	28	5	8	20	5	5	235,57
652.524.00.1	25 / 15 / 25	1"	3/4"	33	5	8	20	5	6	269,22
652.525.00.1	25 / 15 / 25	1"	3/4"	38	5	8	20	5	7	302,94
652.526.00.1	25 / 15 / 25	1"	3/4"	43	5	8	20	5	8	336,54
652.527.00.1	25 / 15 / 25	1"	3/4"	48	5	8	20	5	9	370,24
652.528.00.1	25 / 15 / 25	1"	3/4"	53	5	8	20	5	10	403,87
652.529.00.1	25 / 15 / 25	1"	3/4"	58	5	8	20	5	11	437,54
652.530.00.1	25 / 15 / 25	1"	3/4"	63	5	8	20	5	12	471,19

Robinet de închidere cu bilă

Set de robinete cu bilă Geberit



click & scan

Cod art.	DN	G [„]	G1 [„]	L [cm]	L1 [cm]	H [cm]	Z [cm]	PN [bar]	EUR/buc.
652.418.22.1	25	1"	1 1/4"	6,4	7,1	2,9	1,9	10	64,16

Set de robinete cu bilă de colț Geberit

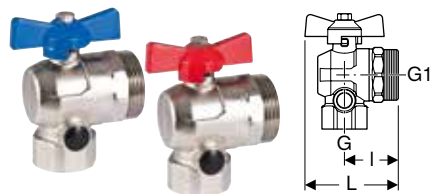

click & scan

Cod art.	DN	G [„]	G1 [„]	arc [°]	L [cm]	I [cm]	PN [bar]	EUR/buc.
652.417.22.1	25	1"	1 1/4"	90	7,7	4,4	10	94,33

Set de robinete cu bilă Geberit cu termometru

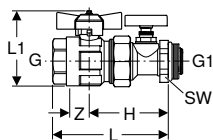

click & scan

Cod art.	DN	G	G1	L	L1	H	Z	SW	PN	EUR/buc.
		[..]	[..]	[cm]	[cm]	[cm]	[cm]	[mm]	[bar]	
652.425.22.1	25	1"	1"	11	7,1	7,5	1,9	38	10	138,88

Set de robinete cu bilă de colț Geberit cu termometru

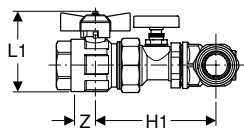
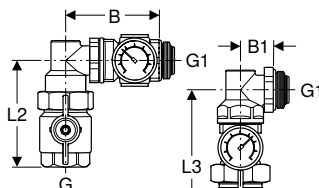
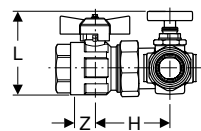

click & scan

Cod art.	DN	G	G1	arc	L	L1	L2	L3	B	B1	H	H1	Z	PN	EUR/buc.
		[..]	[..]	[°]	[cm]	[cm]	[cm]	[cm]	[cm]	[cm]	[cm]	[cm]	[cm]	[bar]	
652.427.22.1	25	1"	1"	90	8	7,1	10	14	8,3	2,9	6,5	10,6	1,9	10	180,51

Termometre

Termometru Geberit pentru robinet de închidere cu bilă de colț



Cod art.
652.420.00.1



click & scan

EUR/buc.

11,82

Adaptoare

Niplu filetat Geberit cu piuliță

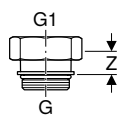

Cod art.	DN	G	G1	L	Z
		[..]	[..]	[cm]	[cm]
652.432.22.1	25 / 32	1"	1 1/4"	3,7	1,6



click & scan

EUR/buc.

13,22

Niplu filetat Geberit cu piuliță și termometru

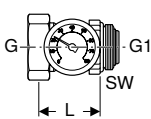

Cod art.	DN	G	G1	L	SW
		[..]	[..]	[cm]	[mm]
652.419.22.1	32 / 25	1 1/4"	1"	4,5	38



click & scan

EUR/buc.

32,72

Încălzire și răcire radiantă

Gamă de distribuitoare

Elemente de închidere pentru distribuitoare

Îmbinare filetată Geberit cu filet exterior, rotativ

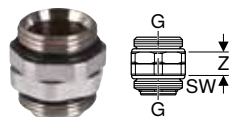

Cod art.	DN	G [.]	Z [cm]	SW [mm]	EUR/buc.
652.430.22.1	25	1"	1,6	37	16,90



click & scan
EUR/buc.

Elemente de închidere pentru distribuitoare

Dop Geberit pentru distribuitor



Cod art.	DN	G [.]	EUR/buc.
652.431.22.1	25	1"	4,06



click & scan
EUR/buc.

Element de capăt Geberit pentru distribuitor cu ventil de golire

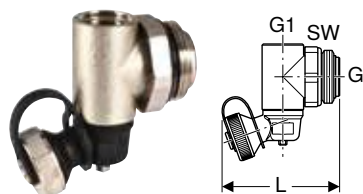

Cod art.	DN	G [.]	G1 [.]	L [cm]	SW [mm]	EUR/buc.
652.433.22.1	25 / 15	1"	1/2"	7,4	37	17,74



click & scan

Divizoare de debit

Divizor de debit Geberit, cu eurocon



Cod art.	DN	G [.]	G1 [.]	L [cm]	EUR/buc.
652.436.22.1	15	3/4"	3/4"	3,6	14,77



click & scan

Unități de reglare a temperaturii

Unitate de reglare a temperaturii Geberit pentru distribuitoare

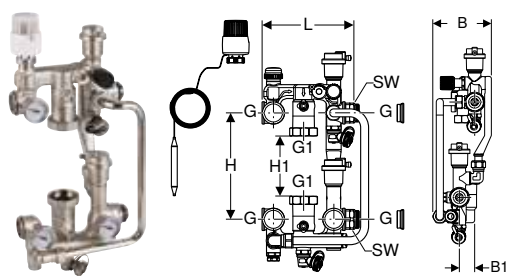

click & scan

Cod art.	DN	G [.]	G1 [.]	L [cm]	B [cm]	B1 [cm]	H [cm]	H1 [cm]	SW [mm]	EUR/buc.
652.413.22.1	25	1"	1 1/2"	17,2	12,5	3,2	20	13,3	37	940,71

De comandat suplimentar

- Set șine de fixare Geberit → p. 165

Distribuitoare pentru circuitele corpurilor de încălzire

Distribuitoare Geberit pentru circuitul radiatoarelor

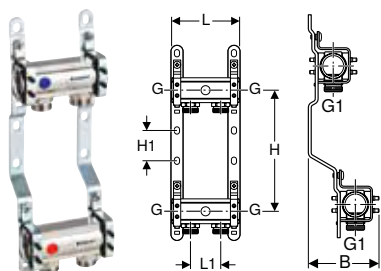

click & scan

Cod art.	DN	G [.]	G1 [.]	L [cm]	L1 [cm]	B [cm]	H [cm]	H1 [cm]	Număr de ieșiri	EUR/buc.
652.414.22.1	25 / 15 / 25	1"	3/4"	11,2	5	10,2	20	5	2	84,99

Unitate de distribuție Geberit pentru circuitul radiatoarelor, deplasată

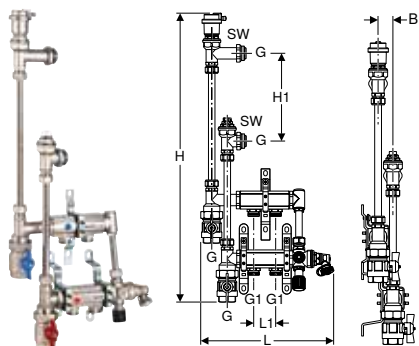

click & scan

Cod art.	DN	G [.]	G1 [.]	L [cm]	L1 [cm]	B [cm]	H [cm]	H1 [cm]	SW [mm]	Număr de ieșiri	EUR/buc.
652.416.22.1	25 / 15 / 25	1"	3/4"	30,3	5	3,2	68,2	20	37	2	487,21

Bypassuri

Unitate de ventile Geberit, pentru bypass

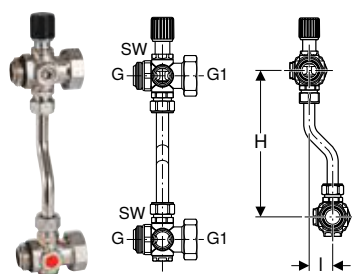

click & scan

Cod art.	DN	G [.]	G1 [.]	I [cm]	H [cm]	SW [mm]	EUR/buc.
652.415.22.1	25	1"	1 1/4"	3,2	20	37	113,19

Componente de reglaj

Servomotoare

Servomotor Geberit



click & scan

Cod art.	M [mm]	Gs [mm]	B [cm]	H [cm]	T [cm]	Tensiune nominală/frecvență a rețelei	Clasă de protecție	Putere consumată (W)	EUR/buc.
651.423.00.1	30	1,5	4,4	5,2	4,8	24 V / 50 Hz	II	1	41,99
651.420.00.1	30	1,5	4,4	5,2	4,8	230 V / 50-60 Hz	II	1	41,99

Servomotor Geberit cu întrerupător de sfârșit de cursă

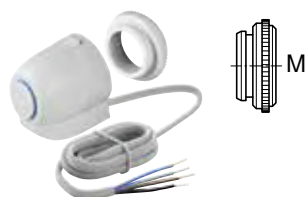

click & scan

Cod art.	M [mm]	Gs [mm]	B [cm]	H [cm]	T [cm]	Tensiune nominală/frecvență a rețelei	Clasă de protecție	Putere consumată (W)	EUR/buc.
651.424.00.1	30	1,5	4,4	5,8	5,6	24 V / 50 Hz	II	2	56,29
651.422.00.1	30	1,5	4,4	5,8	5,6	230 V / 50-60 Hz	II	2	56,29

Termostate de ambianță

Termostat digital de ambianță Geberit

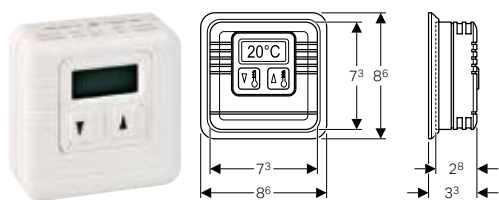

click & scan

Cod art.	B [cm]	H [cm]	T [cm]	Tensiune nominală/ frecvență a rețelei	Clasă de protecție	EUR/buc.
652.401.00.1	8,6	8,6	3,3	3 V DC	II	67,17

Termostat de ambianță Geberit RCD1

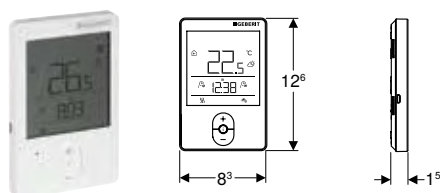

click & scan

Cod art.	B [cm]	H [cm]	T [cm]	Racord	Clasă de protecție	Putere consumată (W)	EUR/buc.
651.425.00.1	8,3	12,6	1,5	Cu fir	III	0,02	196,36
651.426.00.1	8,3	12,6	1,5	Fără fir	III	0,02	246,79

De comandat suplimentar

- 2 baterii alcaline cu mangan tip AA 1,5 V (doar model fără fir)

Termostat de ambianță Geberit RCD2

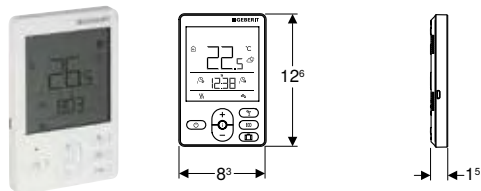

click & scan

Cod art.	B [cm]	H [cm]	T [cm]	Racord	Clasă de protecție	Putere consumată (W)	EUR/buc.
651.427.00.1	8,3	12,6	1,5	Cu fir	III	0,02	252,40
651.428.00.1	8,3	12,6	1,5	Fără fir	III	0,02	322,56

De comandat suplimentar

- 2 baterii alcaline cu mangan tip AA 1,5 V (doar model fără fir)

Regulator principal

Regulator principal Geberit

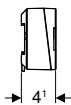
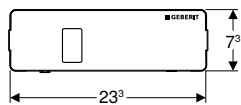

click & scan

Cod art.	B [cm]	H [cm]	T [cm]	Tensiune nominală/frecvență a rețelei	Clasă de protecție	Putere consumată (W)	EUR/buc.
651.432.00.1	23,3	7,3	4,1	230 V / 50 Hz	I	≤ 2100	406,70



- Pentru dispozitive de acționare cu tensiune nominală de 24 V / 50 Hz, este necesar transformatorul Geberit

Module de comunicare

Antenă Geberit

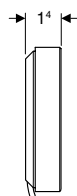
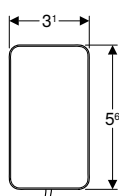

click & scan

Cod art.	B [cm]	H [cm]	T [cm]	EUR/buc.
651.436.00.1	3,1	5,6	1,4	168,30

Senzori

Senzor de temperatură exterioară Geberit

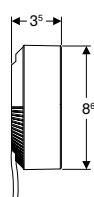

click & scan

Cod art.	T [cm]	EUR/buc.
651.437.00.1	3,5	30,86

Senzor de temperatură țevă Geberit



click & scan

Cod art.	EUR/buc.
651.438.00.1	28,05

Transformatoare

Bloc de alimentare de la rețea Geberit

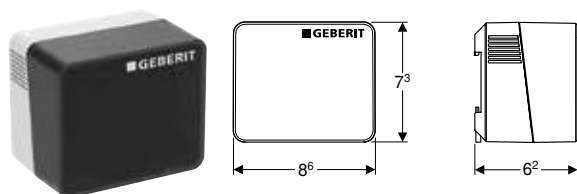

click & scan

Cod art.	B [cm]	H [cm]	T Tensiune nominală/ [cm] frecvență a rețelei	Putere consumată (W)	EUR/buc.
651.440.00.1	8,6	7,3	6,2 230 V / 50 Hz	38	126,18

Accesorii

Izolații pentru distribuitoare

Izolație Geberit pentru distribuitor pentru încălzire prin pardoseală



click & scan

Cod art.	s [mm]	L [cm]	B [cm]	H [cm]	EUR/buc.
652.531.00.1	14,5	67	6,9	6,9	42,03





Geberit Mapress Oțel-Inox

Vedere de ansamblu asupra aplicațiilor – Geberit Mapress Oțel inoxidabil pentru medii lichide	177
Vedere de ansamblu asupra utilizărilor – Geberit Mapress Oțel inoxidabil pentru medii gazoase	177
Modificări dimensionale Geberit Mapress Oțel-Inox aprilie 2023 - aprilie 2024	178
Geberit Mapress Oțel-Inox.....	178
Țevi 1.4401	178
Țeavă 1.4521	178
Țevi 1.4301	179
Mufe	179
Reducții	180
Coturi	181
Teuri	184
Adaptoare, fără posibilitate de desfacere.....	186
Adaptoare și conexiuni, cu posibilitate de desfacere.....	191
Compensatoare.....	196
Treceri	196
Dispozitive de închidere	197
Racorduri	197
Accesorii pentru Geberit Mapress Oțel-Inox	198
Izolații pentru racorduri.....	198
Etanșări pentru țevi și fittinguri.....	198
Dispozitive de fixare pentru țevi	198
Dispozitive de fixare pentru racorduri.....	200
Garnituri de sistem	201
Seturi de șuruburi pentru conexiuni cu flanșă.....	204



Vedere de ansamblu asupra aplicațiilor – Geberit Mapress Oțel inoxidabil pentru medii lichide

Geberit România, Versiune: December 2023

Domenii de utilizare	Temperatură de operare	Presiunea maximă de exploatare	Țevi		
			Oțel CrNiMo 1.4401 / 316	Oțel CrMoTi 1.4521 / 444	Oțel CrNi 1.4301 / 304
Pentru apă potabilă rece și caldă	0–100 °C	16 bar / 1600 kPa ³⁾	✓	✓	
Pentru apă de răcire și de încălzire fără antigel	0–100 °C	16 bar / 1600 kPa	✓	✓	✓
Pentru apă de răcire și de încălzire fără antigel	-30 – +120 °C ¹⁾	16 bar / 1600 kPa	✓	✓	✓
Pentru agent termic de termoficare ≤ 120 °C	0–120 °C	16 bar / 1600 kPa	✓	✓	✓
Pentru agent termic de termoficare ≤ 140 °C	0–140 °C	16 bar / 1600 kPa	✓	✓	✓
Pentru abur saturat ≤ 120 °C	0–120 °C	2 bar/200 kPa	✓		
Pentru abur saturat ≤ 155 °C	0–155 °C	4.5 bar / 450 kPa	✓		
Pentru apa de operare și de proces	0–100 °C	16 bar / 1600 kPa	5)	5)	
Pentru apă tratată	0–100 °C	16 bar / 1600 kPa	✓ ⁶⁾	✓ ⁶⁾	
Pentru apă de ploaie cu valoarea > 6.0	0–100 °C	16 bar / 1600 kPa	✓	✓	
Pentru ape gri și negre cu valoarea pH > 6.0	0–100 °C	16 bar / 1600 kPa	✓	✓	
Pentru apă pentru stingerea incendiilor (umed)	0–100 °C	16 bar / 1600 kPa	✓		
Pentru apă pentru stingerea incendiilor (umed/uscat, uscat)	0–100 °C	16 bar / 1600 kPa	✓		
Pentru sprinklere (umed)	0–100 °C	16 / 10 bar ⁴⁾ 1600 / 1000 kPa	✓		
Pentru sprinklere (umed/uscat, uscat)	0–100 °C	16 / 10 bar ⁴⁾ 1600 / 1000 kPa	✓		
Pentru agenți termici (solar)	-25 – +220 °C ²⁾¹⁾	16 bar / 1600 kPa	✓	✓	✓
Pentru uleiuri minerale și de lubrifiere	La cerere	La cerere	5)		
Pentru combustibili (de ex. diesel)	La cerere	La cerere	5)		
Pentru produse chimice și fluide tehnice	La cerere	La cerere	5)		

✓ Utilizare generală aprobată, dacă sunt îndeplinite condițiile suplimentare definite conform notelor de subsol

¹⁾ Utilizarea inhibitorilor, a agenților de protecție împotriva coroziunii, a agenților de protecție la îngheț numai după aprobarea Geberit

²⁾ Durată de viață cu colectorul oprit: 200 h/a la 180 °C; 60 h/a la 200 °C; total 500 h/durată de viață la 220 °C

³⁾ 10 bar / 1000 kPa pentru MasterFix și MeplaFix

⁴⁾ 16 bar / 1600 kPa pentru d22–76.1 mm, 10 bar / 1000 kPa pentru d88.9–108 mm

⁵⁾ Following Geberit approval

⁶⁾ Domeniu de aplicare în conformitate cu informațiile tehnice (TI) "Ape tratate"

⁷⁾ Pot fi utilizate doar fittinguri cu piuliță olandeză din oțel CrNi



- Pentru fiecare aplicație se vor respecta condițiile de utilizare din autorizațiile de referință, norme și reglementări tehnice. Ele pot diferi de datele specificate

Vedere de ansamblu asupra utilizărilor – Geberit Mapress Oțel inoxidabil pentru medii gazoase

Geberit România, Versiune: December 2023

Domenii de utilizare	Temperatură de operare	Presiunea maximă de exploatare	Țevi			
			Oțel CrNiMo 1.4401 / 316	Oțel CrMoTi 1.4521 / 444	Oțel CrNi 1.4301 / 304	Oțel CrTi 1.4520/439
Pentru aer comprimat (clasa de puritate a uleiului 0–3)	0–100 °C	25/16/12 bar 2500/1600/1200 kPa	✓ ³⁾	✓ ³⁾	✓ ³⁾	✓ ³⁾
Pentru aer comprimat (clasă de puritate ulei 0–X)	0–100 °C	25/16/12 bar 2500/1600/1200 kPa	✓ ³⁾	✓ ³⁾	✓ ³⁾	✓ ³⁾
Pentru presiune negativă ¹⁾	0–100 °C	Abs. ≥ 0,2 bar/20 kPa	✓	4)	4)	4)
Pentru gaze inerte (de ex. azot)	0–100 °C	25/16/12 bar 2500/1600/1200 kPa	✓ ³⁾	✓ ³⁾	✓ ³⁾	✓ ³⁾
Pentru gaze industriale (de ex. acetilenă, gaze de protecție pentru sudură)	La cerere	La cerere	4)			
Pentru gaz metan	-20 – +70 °C	MOP 5 / GT 5 ²⁾	✓			
Pentru gaze lichefiate	-20 – +70 °C	MOP 5 / GT 5 ²⁾	✓			
Pentru biogaze	La cerere	La cerere	4)			

✓ Utilizare generală aprobată, dacă sunt îndeplinite condițiile suplimentare definite conform notelor de subsol

¹⁾ Presiune negativă utilizabilă pentru sisteme de conducte Geberit:

Presiunea negativă utilizabilă rezultă din presiunea aerului la locul de instalare minus presiunea absolută de 200 mbar.

Exemplu: presiunea aerului 980 mbar - presiune absolută 200 mbar = presiune negativă utilizabilă pe sistemul de conducte 780 mbar

²⁾ GT 0.1, când există un filet > 2"

³⁾ 25 bar / 2500 kPa for d12–54 mm (d35–54mm only with pressing collars), 16 bar / 1600 kPa for d76.1 mm, 12 bar / 1200 kPa für d88.9–108 mm

⁴⁾ Following Geberit approval

⁵⁾ Clasă de puritate a uleiului conform ISO 8573-1:2010E; pentru detalii referitoare la umiditate și particule, vezi Informațiile tehnice "Sisteme de conducte Geberit pentru instalații de aer comprimat"



- Pentru fiecare aplicație se vor respecta condițiile de utilizare din autorizațiile de referință, norme și reglementări tehnice. Ele pot diferi de datele specificate

Fitinguri		Inele de etanșare				Garnituri plate pentru îmbinări filetate			Garnituri de flanșă
Oțel inoxidabil indicator albastru	Alamă roșie indicator alb	CIIR negru	FKM albastru	FKM alb	FPM roșu	EPDM negru	FPM verde	Fibre compozite	Fibre compozite
✓	✓	✓				✓		✓	✓
✓	✓	✓ ¹⁾				✓ ¹⁾		✓	✓
✓	✓	✓ ¹⁾						✓ ⁷⁾	✓
✓	✓	✓ ¹⁾					✓	✓ ⁷⁾	✓
✓	✓		✓ ¹⁾					✓ ⁷⁾	✓
✓		✓ ¹⁾						✓ ⁷⁾	✓
✓				✓ ¹⁾				✓ ⁷⁾	✓
5)		5)				5)		5)	5)
✓ ⁶⁾		✓ ⁶⁾				✓ ⁶⁾		✓ ⁶⁾	✓ ⁶⁾
✓		✓				✓		✓	✓
✓		✓				✓		✓	✓
✓		✓				✓		✓	✓
✓			✓		✓		✓	✓	✓
✓		✓				✓		✓	✓
✓			✓		✓		✓	✓	✓
✓	✓		✓				✓	✓ ⁷⁾	✓
5)			5)				5)	5)	5)
5)			5)				5)	5)	5)
5)		5)	5)			5)	5)	5)	5)

Fitinguri		Inele de etanșare			Garnituri plate pentru îmbinări filetate			Garnituri de flanșă
Oțel inoxidabil indicator albastru		CIIR negru	FKM albastru	HNBR galben	EPDM negru	FPM verde	Fibre compozite	Fibre compozite
✓		✓ ⁵⁾			✓ ⁵⁾		✓	✓
✓			✓ ⁵⁾			✓ ⁵⁾	✓	✓
✓		✓					✓	✓
✓		✓			✓		✓	✓
4)		4)					4)	4)
✓				✓			✓	✓
✓				✓			✓	✓
4)				4)			4)	4)



Modificări dimensionale Geberit Mapress Oțel-Inox aprilie 2023 - aprilie 2024

Geberit România, Versiune: December 2023

		arc / cot (°)	DN	d, ø	L	H	Z
Cot Geberit Mapress Oțel-Inox	30102	90°	12	15 mm	3.8 cm		1.8 cm
	30104	90°	20	22 mm	4.7 cm		2.6 cm
Cot Geberit Mapress Oțel-Inox, cu capăt drept	30302	90°	12	15 mm	3.8 cm	4.8 cm	1.8 cm
	30303	90°	15	18 mm	4.2 cm	5.2 cm	2.2 cm
	30304	90°	20	22 mm	4.7 cm	5.8 cm	2.6 cm



- Între aprilie 2023 și aprilie 2024, dimensiunile articolelor de mai sus se vor modifica conform tabel. Aceste articole cu noile dimensiuni vor avea un X suplimentar pe etichetă

Geberit Mapress Oțel-Inox

Țevi 1.4401

Țeavă Geberit Mapress Oțel-Inox CrNiMo

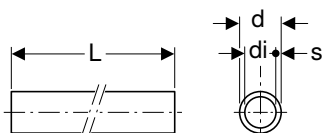
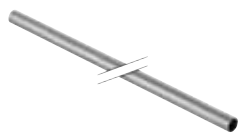

click & scan

Cod art.	DN	d, ø [mm]	di, ø [mm]	s [mm]	L [cm]	L [m]	EUR/m
39002	12	15	13	1	600	6	9,43
39003	15	18	16	1	600	6	11,47
39004	20	22	19,6	1,2	600	6	15,74
39005	25	28	25,6	1,2	600	6	19,07
39006	32	35	32	1,5	600	6	28,43
39007	40	42	39	1,5	600	6	33,75
39008	50	54	51	1,5	600	6	43,53
39009	65	76,1	72,1	2	600	6	90,90
39010	80	88,9	84,9	2	600	6	103,19
39011	100	108	104	2	600	6	132,74

Accesorii

- Aparat de tăiat țevi Geberit Mapress R → p. 324
- Aparat de debavurat țevi Geberit Mapress → p. 324
- Șablon de adâncime Geberit Mapress, cu știft de marcare → p. 325
- Debavurator electric de țevi Geberit RE 1 Mapress, în trusă → p. 324

Țeavă 1.4521

Țeavă Geberit Mapress Oțel-Inox CrMoTi

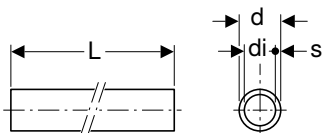
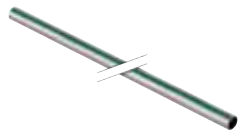

click & scan

Cod art.	DN	d, ø [mm]	di, ø [mm]	s [mm]	L [cm]	L [m]	EUR/m
39041	10	12	10	1	600	6	7,34
39042	12	15	13	1	600	6	7,72
39043	15	18	16	1	600	6	9,45
39044	20	22	19,6	1,2	600	6	12,97
39045	25	28	25,6	1,2	600	6	15,64
39046	32	35	32	1,5	600	6	23,30
39047	40	42	39	1,5	600	6	27,92
39048	50	54	51	1,5	600	6	37,18

Accesorii

- Aparat de tăiat țevi Geberit Mapress R → p. 324
- Aparat de debavurat țevi Geberit Mapress → p. 324
- Șablon de adâncime Geberit Mapress, cu știft de marcare → p. 325
- Debavurator electric de țevi Geberit RE 1 Mapress, în trusă → p. 324

Țevi 1.4301

Geberit Mapress Oțel-Inox țevă CrNi

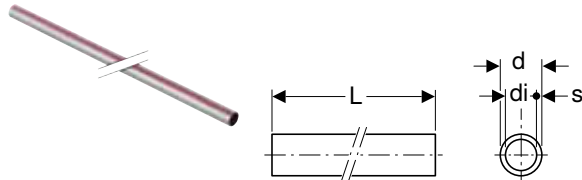

click & scan

Cod art.	DN	d, ø [mm]	di, ø [mm]	s [mm]	L [cm]	L [m]	EUR/m
39102	12	15	13	1	600	6	7,61
39103	15	18	16	1	600	6	9,31
39104	20	22	19,6	1,2	600	6	12,78
39105	25	28	25,6	1,2	600	6	14,57
39106	32	35	32	1,5	600	6	21,60
39107	40	42	39	1,5	600	6	26,46
39108	50	54	51	1,5	600	6	33,47
39609	65	76,1	73,1	1,5	600	6	60,13
39610	80	88,9	85,9	1,5	600	6	68,53
39611	100	108	104	2	600	6	107,20

Accesorii

- Aparat de tăiat țevi Geberit Mapress R → p. 324
- Aparat de debavurat țevi Geberit Mapress → p. 324
- Șablon de adâncime Geberit Mapress, cu știft de marcare → p. 325
- Debavurator electric de țevi Geberit RE 1 Mapress, în trusă → p. 324

Mufe

Mufă Geberit Mapress Oțel-Inox



click & scan
EUR/buc.

Cod art.	DN	d, ø [mm]	L [cm]	Z [cm]	EUR/buc.
33001	10	12	4,2	0,8	8,13
32002	12	15	4,8	0,8	7,14
32003	15	18	4,8	0,8	7,61
32004	20	22	5	0,8	8,96
32005	25	28	5,4	0,8	10,37
32006	32	35	6,2	1	12,53
32007	40	42	7,1	1,1	17,03
32008	50	54	8,3	1,3	20,42
32009	65	76,1	12,7	2,1	100,60
32010	80	88,9	14,5	2,5	115,08
32011	100	108	17,6	2,6	147,97

Mufă de inserție Geberit Mapress Oțel-Inox

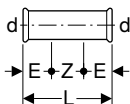

click & scan
EUR/buc.

Cod art.	DN	d, ø [mm]	E [cm]	L [cm]	Z [cm]	
32102	12	15	2,5	8	3	11,84
32103	15	18	2,5	8	3	12,30
32104	20	22	2,5	8,4	3,4	13,98
32105	25	28	3	9,1	3,1	16,27
32106	32	35	3	10,2	4,2	18,12
32107	40	42	4	12	4	21,08
32108	50	54	4	14	6	27,31
32109	65	76,1	6	23	11	149,57
32110	80	88,9	7	26	12	169,30
32111	100	108	8	31	15	203,82

Reducții

Reducție Geberit Mapress Oțel-Inox, cu capăt drept

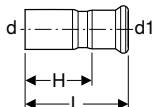

click & scan
EUR/buc.

Cod art.	DN	d, ø [mm]	d1, ø [mm]	L [cm]	H [cm]	
32303	15 / 12	18	15	5,5	3,5	7,58
32305	20 / 12	22	15	5,9	3,9	8,41
32306	20 / 15	22	18	5,7	3,7	8,41
32307	25 / 12	28	15	6,6	4,6	9,52
32308	25 / 15	28	18	6,4	4,4	9,52
32309	25 / 20	28	22	6	3,9	9,52
32310	32 / 12	35	15	7,5	5,5	15,10
32311	32 / 15	35	18	7,4	5,4	15,10
32312	32 / 20	35	22	7,1	5	15,10
32313	32 / 25	35	28	6,8	4,5	15,10
32314	40 / 12	42	15	8,1	6,1	19,90
32315	40 / 15	42	18	8	6	19,90
32316	40 / 20	42	22	8,2	6,1	19,90
32317	40 / 25	42	28	8,3	6	19,90
32318	40 / 32	42	35	7,7	5,1	19,90
32319	50 / 12	54	15	9,7	7,7	28,00
32320	50 / 15	54	18	9,6	7,6	28,00
32321	50 / 20	54	22	9,5	7,4	28,00
32322	50 / 25	54	28	11	8,7	28,00
32323	50 / 32	54	35	10,6	8	28,00
32324	50 / 40	54	42	9,2	6,2	28,00
32331	65 / 50	76,1	54	14,6	11,1	86,63
32338	80 / 50	88,9	54	16,2	12,8	93,38
32339	80 / 65	88,9	76,1	16,1	10,8	93,38
32345	100 / 50	108	54	17,2	13,7	100,27
32346	100 / 65	108	76,1	18,4	13,1	100,27
32348	100 / 80	108	88,9	20,3	14,3	100,27

Coturi

Cot Geberit Mapress Oțel-Inox

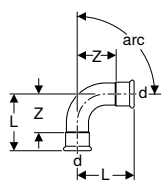

Cod art.	DN	d, ø [mm]	L [cm]	Z [cm]	EUR/buc.
arc / cot: 15°					
36101	12	15	3	1	10,43
36103	20	22	3,2	1,1	14,17
36104	25	28	3,6	1,3	17,91
36105	32	35	3,2	0,6	23,86
36106	40	42	3,7	0,7	37,84
36107	50	54	4,4	0,9	50,18
36108	65	76,1	7,5	2,2	147,97
36109	80	88,9	8,5	2,5	177,53
36110	100	108	10,3	2,8	243,21
arc / cot: 30°					
36121	12	15	3,3	1,3	10,43
36123	20	22	3,7	1,6	14,17
36124	25	28	4,1	1,8	17,91
36125	32	35	3,7	1,1	23,86
36126	40	42	4,4	1,4	37,84
36127	50	54	5,2	1,7	50,18
36128	65	76,1	8,8	3,5	147,97
36129	80	88,9	10,1	4,1	177,53
36130	100	108	12,2	4,7	243,21
arc / cot: 45°					
30602	12	15	2,8	0,8	10,43
30603	15	18	2,9	0,9	11,66
30604	20	22	3,2	1,1	14,17
30605	25	28	3,5	1,4	17,91
32606	32	35	4,3	1,7	23,86
32607	40	42	5,1	2,1	37,84
32608	50	54	6,2	2,7	50,18
32609	65	76,1	10,3	5	147,97
32610	80	88,9	11,7	5,7	177,53
32611	100	108	14,3	6,8	243,21
arc / cot: 60°					
36161	12	15	4	2	10,43
36163	20	22	4,7	2,6	14,17
36164	25	28	5,4	3,1	17,91
36165	32	35	5	2,4	23,86
36166	40	42	5,9	2,9	37,84
36167	50	54	7,2	3,7	50,18
36168	65	76,1	11,7	6,4	147,97
36169	80	88,9	13,6	7,6	177,53
36170	100	108	16,6	9,1	243,21
arc / cot: 90°					
30102	12	15	3,8	1,8	10,43
30103	15	18	5,3	3,3	11,66
30104	20	22	4,7	2,6	14,17
30105	25	28	5,5	3,4	17,91
31106	32	35	6,8	4,2	23,86
31107	40	42	8	5	37,84
31108	50	54	10	6,5	50,18
31109	65	76,1	15,9	10,6	147,97
31110	80	88,9	18,5	12,5	177,53
31111	100	108	23	15,5	243,21



Cot Geberit Mapress Oțel-Inox, cu capăt drept

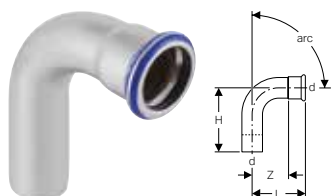

click & scan

Cod art.	DN	d, ø [mm]	L [cm]	H [cm]	Z [cm]	EUR/buc.
arc / cot: 45°						
30702	12	15	2,8	3,6	0,8	10,43
30703	15	18	2,9	3,6	0,9	11,66
30704	20	22	3,2	3,9	1,1	14,17
30705	25	28	3,5	4,5	1,4	17,91
32706	32	35	4,3	5	1,7	23,86
32707	40	42	5,1	5,9	2,1	37,84
32708	50	54	6,2	7	2,7	50,18
32709	65	76,1	10,3	11,1	5	147,97
32710	80	88,9	11,7	12,8	5,7	177,53
32711	100	108	14,3	15,8	6,8	243,21
arc / cot: 90°						
30302	12	15	3,8	4,8	1,8	10,43
30303	15	18	4,2	5,2	2,2	11,66
30304	20	22	4,7	5,8	2,6	14,17
30305	25	28	5,7	6,5	3,4	17,91
33306	32	35	6,8	7,4	4,2	23,86
33307	40	42	8	8,8	5	37,84
33308	50	54	10	10,8	6,5	50,18
33309	65	76,1	15,9	16,7	10,6	147,97
33310	80	88,9	18,5	19,5	12,5	177,53
33311	100	108	23	24,1	15,5	243,21

Cot de adaptare Geberit Mapress Oțel-Inox

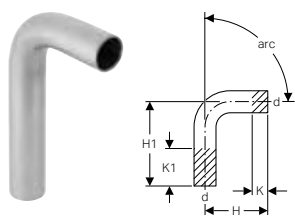

click & scan

Cod art.	DN	d, ø [mm]	H [cm]	H1 [cm]	K [cm]	K1 max. [cm]	EUR/buc.
arc / cot: 15°							
30892	12	15	4	11	0	7	11,19
30893	15	18	4	11,2	0	7,1	12,58
30894	20	22	4,1	11,4	0	7,3	15,26
30905	25	28	4,3	11,9	0	7,6	19,40
30906	32	35	4,1	11,8	0	7,7	25,77
30907	40	42	4,7	13,7	0	9	40,87
30908	50	54	5,5	14,9	0	9,4	54,14
30009	65	76,1	8,4	20,4	0	12	151,83
30010	80	88,9	9,5	22	0	12,5	182,12
30011	100	108	11,7	25,4	0	13,7	249,60
arc / cot: 30°							
30932	12	15	4,3	11,3	0	7	11,19
30933	15	18	4,4	11,6	0	7,1	12,58
30934	20	22	4,6	11,8	0	7,2	15,26
30935	25	28	4,8	12,4	0	7,6	19,40
30936	32	35	4,6	12,3	0	7,7	25,77
30937	40	42	5,4	14,4	0	9	40,87
30938	50	54	6,3	15,7	0	9,4	54,14
30029	65	76,1	9,7	21,7	0	12	151,83
30030	80	88,9	11,1	23,6	0	12,5	182,12
30031	100	108	13,6	27,3	0	13,7	249,60

Cod art.	DN	d, ø [mm]	H [cm]	H1 [cm]	K [cm]	K1 max. [cm]	EUR/buc.
arc / cot: 45°							
30872	12	15	4,5	11,6	0	7,1	11,19
30873	15	18	4,2	11,7	0	7,5	12,58
30874	20	22	5,2	12,3	0	7,1	15,26
30875	25	28	5,6	13,1	0	7,5	19,40
30876	32	35	5,3	12,9	0	7,6	25,77
30877	40	42	6,1	15,1	0	9	40,87
30878	50	54	7,3	16,7	0	9,4	54,14
30049	65	76,1	11,1	23	0	11,9	151,83
30050	80	88,9	13	25,2	0	12,2	182,12
30051	100	108	15,7	29,4	0	13,7	249,60
arc / cot: 60°							
30942	12	15	5	12	0	7	11,19
30943	15	18	5,3	12,4	0	7,1	12,58
30944	20	22	5,6	12,8	0	7,2	15,26
30955	25	28	6,1	13,7	0	7,6	19,40
30956	32	35	5,9	13,6	0	7,7	25,77
30957	40	42	6,9	15,9	0	9	40,87
30958	50	54	8,3	17,7	0	9,4	54,14
30069	65	76,1	12,6	24,6	0	12	151,83
30070	80	88,9	14,6	27,1	0	12,5	182,12
30071	100	108	18	31,7	0	13,7	249,60
arc / cot: 90°							
30402	12	15	5,9	12,9	0	7	11,19
30403	15	18	6,1	13,3	0	7,2	12,58
30404	20	22	7	14,2	0	7,2	15,26
30405	25	28	7,9	15,5	0	7,6	19,40
30406	32	35	7,7	15,4	0	7,7	25,77
30407	40	42	9	18	0	9	40,87
30408	50	54	11,1	20,5	0	9,4	54,14
30089	65	76,1	16,6	28,6	0	12	151,83
30090	80	88,9	19,4	31,9	0	12,5	182,12
30091	100	108	24	37,7	0	13,7	249,60

Cot de adaptare Geberit Mapress Oțel-Inox 90°, lungime

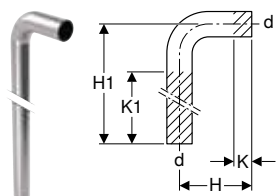

click & scan

Cod art.	DN	d, ø [mm]	arc [°]	H [cm]	H1 [cm]	K [cm]	K1 max. [cm]	EUR/buc.
30414	20	22	90	7	84	1,5	70	38,20
30415	25	28	90	8	85	1,7	77	40,95



Cot în S Geberit Mapress Oțel-Inox

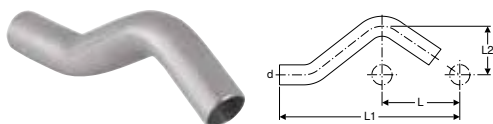

click & scan

Cod art.	DN	d, ø [mm]	L [cm]	L1 [cm]	L2 [cm]	EUR/buc.
30802	12	15	6	16,5	3,2	10,86
30803	15	18	6	16,6	3,3	11,35
30804	20	22	6	16,8	3,5	12,87
30805	25	28	6	17,9	3,8	15,82

Teuri

Teu Geberit Mapress Oțel-Inox, egal

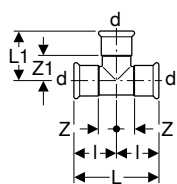

click & scan

Cod art.	DN	d, ø [mm]	arc [°]	L [cm]	L1 [cm]	l [cm]	Z [cm]	Z1 [cm]	EUR/buc.
33008	10	12	90	5,6	3,5	2,8	1,1	1,8	14,19
31002	12	15	90	6,4	3,9	3,2	1,2	1,9	16,60
31003	15	18	90	6,8	4,1	3,4	1,4	2,1	17,12
31004	20	22	90	7,4	4,4	3,7	1,6	2,3	18,12
31005	25	28	90	8,4	5	4,2	1,9	2,7	21,95
31006	32	35	90	10	5,7	5	2,4	3,1	27,31
31007	40	42	90	11,4	6,5	5,7	2,7	3,5	39,47
31008	50	54	90	13,8	7,7	6,9	3,4	4,2	45,71
31009	65	76,1	90	23	11	11,5	6,2	5,7	236,63
31010	80	88,9	90	26	12,7	13	7	6,7	246,58
31011	100	108	90	31	15,3	15,5	8	7,8	304,05

Teu Geberit Mapress Oțel-Inox, redus

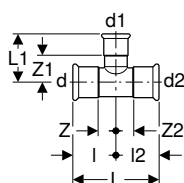

click & scan

Cod art.	DN	d, ø [mm]	d1, ø [mm]	d2, ø [mm]	arc [°]	L [cm]	L1 [cm]	l [cm]	l2 [cm]	Z [cm]	Z1 [cm]	Z2 [cm]	EUR/buc.
31208	15 / 12 / 12	18	15	15	90	7,9	4,1	3,4	4,5	1,4	2,1	2,5	17,12
31204	15 / 12 / 15	18	15	18	90	6,8	4,1	3,4	3,4	1,4	2,1	1,4	17,12
31227	20 / 12 / 15	22	15	18	90	8,5	4,3	3,7	4,8	1,6	2,3	2,8	18,12
31206	20 / 12 / 20	22	15	22	90	7,4	4,3	3,7	3,7	1,6	2,3	1,6	18,12
31228	20 / 15 / 15	22	18	18	90	8,5	4,3	3,7	4,8	1,6	2,3	2,8	18,12
31207	20 / 15 / 20	22	18	22	90	7,4	4,3	3,7	3,7	1,6	2,3	1,6	18,12
31209	25 / 12 / 25	28	15	28	90	8,4	4,6	4,2	4,2	1,9	2,6	1,9	22,39
31210	25 / 15 / 25	28	18	28	90	8,4	4,6	4,2	4,2	1,9	2,6	1,9	22,39
31234	25 / 20 / 20	28	22	22	90	9	4,7	4,2	4,8	1,9	2,6	2,7	22,39
31211	25 / 20 / 25	28	22	28	90	8,4	4,7	4,2	4,2	1,9	2,6	1,9	22,39
31212	32 / 12 / 32	35	15	35	90	10	4,9	5	5	2,4	2,9	2,4	27,86
31213	32 / 15 / 32	35	18	35	90	10	4,9	5	5	2,4	2,9	2,4	27,86
31235	32 / 20 / 25	35	22	28	90	10,4	5	5	5,4	2,4	2,9	3,1	27,86
31214	32 / 20 / 32	35	22	35	90	10	5	5	5	2,4	2,9	2,4	27,86
31242	32 / 25 / 25	35	28	28	90	10,4	5,3	5	5,4	2,4	3	3,1	27,86
31215	32 / 25 / 32	35	28	35	90	10	5,3	5	5	2,4	3	2,4	27,86
31216	40 / 12 / 40	42	15	42	90	11,4	5,3	5,7	5,7	2,7	3,3	2,7	40,26
31217	40 / 15 / 40	42	18	42	90	11,4	5,3	5,7	5,7	2,7	3,3	2,7	40,26
31243	40 / 20 / 32	42	22	35	90	11,5	5,4	5,7	5,8	2,7	3,3	3,2	40,26
31218	40 / 20 / 40	42	22	42	90	11,4	5,4	5,7	5,7	2,7	3,3	2,7	40,26
31251	40 / 25 / 32	42	28	35	90	11,5	5,7	5,7	5,8	2,7	3,4	3,2	40,26
31219	40 / 25 / 40	42	28	42	90	11,4	5,7	5,7	5,7	2,7	3,4	2,7	40,26
31220	40 / 32 / 40	42	35	42	90	11,4	6,1	5,7	5,7	2,7	3,5	2,7	40,26
31221	50 / 12 / 50	54	15	54	90	13,8	5,9	6,9	6,9	3,4	3,9	3,4	45,71
31222	50 / 15 / 50	54	18	54	90	13,8	5,9	6,9	6,9	3,4	3,9	3,4	45,71
31223	50 / 20 / 50	54	22	54	90	13,8	6	6,9	6,9	3,4	3,9	3,4	45,71
31224	50 / 25 / 50	54	28	54	90	13,8	6,3	6,9	6,9	3,4	4	3,4	45,71
31225	50 / 32 / 50	54	35	54	90	13,8	6,7	6,9	6,9	3,4	4,1	3,4	45,71
31226	50 / 40 / 50	54	42	54	90	13,8	7,1	6,9	6,9	3,4	4,1	3,4	45,71
31229	65 / 20 / 65	76,1	22	76,1	90	23	7,2	11,5	11,5	6,2	5,1	6,2	241,37
31230	65 / 25 / 65	76,1	28	76,1	90	23	7,5	11,5	11,5	6,2	5,2	6,2	241,37
31231	65 / 32 / 65	76,1	35	76,1	90	23	7,9	11,5	11,5	6,2	5,3	6,2	241,37

Cod art.	DN	d, ø [mm]	d1, ø [mm]	d2, ø [mm]	arc [°]	L [cm]	L1 [cm]	l [cm]	l2 [cm]	Z [cm]	Z1 [cm]	Z2 [cm]	EUR/buc.
31232	65 / 40 / 65	76,1	42	76,1	90	23	8,3	11,5	11,5	6,2	5,3	6,2	241,37
31233	65 / 50 / 65	76,1	54	76,1	90	23	8,9	11,5	11,5	6,2	5,4	6,2	241,37
31236	80 / 20 / 80	88,9	22	88,9	90	26	7,8	13	13	7	5,7	7	246,58
31237	80 / 25 / 80	88,9	28	88,9	90	26	8,1	13	13	7	5,8	7	246,58
31238	80 / 32 / 80	88,9	35	88,9	90	26	8,5	13	13	7	5,9	7	246,58
31239	80 / 40 / 80	88,9	42	88,9	90	26	8,9	13	13	7	5,9	7	246,58
31240	80 / 50 / 80	88,9	54	88,9	90	26	9,5	13	13	7	6	7	246,58
31241	80 / 65 / 80	88,9	76,1	88,9	90	26	11,6	13	13	7	6,3	7	246,58
31244	100 / 20 / 100	108	22	108	90	31	8,8	15,5	15,5	8	6,7	8	304,05
31245	100 / 25 / 100	108	28	108	90	31	9,1	15,5	15,5	8	6,8	8	304,05
31246	100 / 32 / 100	108	35	108	90	31	9,5	15,5	15,5	8	6,9	8	304,05
31247	100 / 40 / 100	108	42	108	90	31	9,9	15,5	15,5	8	6,9	8	304,05
31248	100 / 50 / 100	108	54	108	90	31	10,5	15,5	15,5	8	7	8	304,05
31249	100 / 65 / 100	108	76,1	108	90	31	12,6	15,5	15,5	8	7,3	8	304,05
31250	100 / 80 / 100	108	88,9	108	90	31	13,7	15,5	15,5	8	7,7	8	304,05

Teu Geberit Mapress Oțel-Inox, cu filet exterior

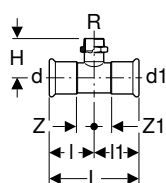

Cod art.	DN	d, ø [mm]	R ["]	d1, ø [mm]	arc [°]	L [cm]	l [cm]	l1 [cm]	H [cm]	Z [cm]	Z1 [cm]	EUR/buc.
31401	12 / 10 / 12	15	3/8"	15	90	6,4	3,2	3,2	5	1,2	1,2	22,90
31454	12 / 15 / 12	15	1/2"	15	90	6,4	3,2	3,2	4	1,2	1,2	18,12
31455	15	18	1/2"	18	90	6,8	3,4	3,4	4,2	1,4	1,4	18,12
31458	20	22	3/4"	22	90	7,4	3,7	3,7	4,8	1,6	1,6	19,90
31461	25	28	1"	28	90	8,4	4,2	4,2	5,4	1,9	1,9	27,14
31464	32	35	1 1/4"	35	90	10	5	5	6	2,4	2,4	33,14



Teu Geberit Mapress Oțel-Inox, cu filet interior

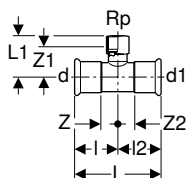

click & scan

Cod art.	DN	d, ø [mm]	Rp ["]	d1, ø [mm]	arc [°]	L [cm]	L1 [cm]	I [cm]	I2 [cm]	Z [cm]	Z1 [cm]	Z2 [cm]	EUR/buc.
31304	12 / 15 / 12	15	1/2"	15	90	6,4	4	3,2	3,2	1,2	2,7	1,2	18,12
31305	15	18	1/2"	18	90	6,8	4,1	3,4	3,4	1,4	2,9	1,4	18,12
31306	15 / 20 / 15	18	3/4"	18	90	6,8	4,4	3,4	3,4	1,4	2,9	1,4	18,12
31307	20 / 15 / 20	22	1/2"	22	90	7,4	4,3	3,7	3,7	1,6	3	1,6	19,90
31308	20	22	3/4"	22	90	7,4	4,6	3,7	3,7	1,6	3,1	1,6	19,90
31309	25 / 15 / 25	28	1/2"	28	90	8,4	4,6	4,2	4,2	1,9	3,3	1,9	22,22
31310	25 / 20 / 25	28	3/4"	28	90	8,4	4,9	4,2	4,2	1,9	3,4	1,9	22,22
31311	25	28	1"	28	90	8,4	5,3	4,2	4,2	1,9	3,6	1,9	22,22
31312	32 / 15 / 32	35	1/2"	35	90	10	5	5	5	2,4	3,7	2,4	27,00
31313	32 / 20 / 32	35	3/4"	35	90	10	5,3	5	5	2,4	3,8	2,4	27,00
31314	32 / 25 / 32	35	1"	35	90	10	5,6	5	5	2,4	3,9	2,4	26,99
31316	40 / 15 / 40	42	1/2"	42	90	11,4	5,3	5,7	5,7	2,7	4	2,7	32,91
31317	40 / 20 / 40	42	3/4"	42	90	11,4	5,6	5,7	5,7	2,7	4,1	2,7	32,91
31318	40 / 25 / 40	42	1"	42	90	11,4	6	5,7	5,7	2,7	4,3	2,7	32,90
31320	50 / 15 / 50	54	1/2"	54	90	13,8	5,9	6,9	6,9	3,4	4,6	3,4	40,08
31321	50 / 20 / 50	54	3/4"	54	90	13,8	6,2	6,9	6,9	3,4	4,7	3,4	40,08
31322	50 / 25 / 50	54	1"	54	90	13,8	6,6	6,9	6,9	3,4	4,9	3,4	40,08
31324	50	54	2"	54	90	13,8	7,9	6,9	6,9	3,4	5,6	3,4	40,08
31326	65 / 20 / 65	76,1	3/4"	76,1	90	23	7,4	11,5	11,5	6,2	5,9	6,2	229,99
31329	65 / 50 / 65	76,1	2"	76,1	90	23	9,1	11,5	11,5	6,2	6,8	6,2	229,99
31331	80 / 20 / 80	88,9	3/4"	88,9	90	26	8	13	13	7	6,5	7	249,85
31334	80 / 50 / 80	88,9	2"	88,9	90	26	9,7	13	13	7	7,4	7	249,85
31336	100 / 20 / 100	108	3/4"	108	90	31	9	15,5	15,5	8	7,5	8	300,74
31339	100 / 50 / 100	108	2"	108	90	31	10,7	15,5	15,5	8	8,4	8	300,74

Adaptoare, fără posibilitate de desfacere

Nou

Adaptor Geberit FlowFit la Geberit Mapress, cu capăt drept, din oțel inoxidabil

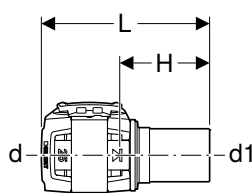

click & scan

Cod art.	DN	d, ø [mm]	d1, ø [mm]	L [cm]	H [cm]	EUR/buc.
620.250.00.1	12	16	15	7,1	3,8	18,40
620.252.00.1	15 / 20	20	22	7,2	3,9	21,66
620.253.00.1	20	25	22	7,2	3,9	27,07
620.254.00.1	25	32	28	7,9	4,3	35,27
620.255.00.1	32	40	35	8,2	4,6	47,69
620.256.00.1	40	50	42	12,5	6,6	81,27
620.257.00.1	50	63	54	14,2	7,9	105,68

Livrabil din April 2024

Nou

Adaptor Geberit FlowFit la Geberit Mapress, cu capăt drept

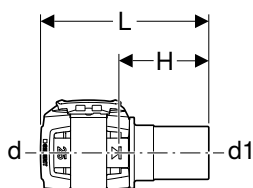

click & scan

Cod art.	DN	d, ø [mm]	d1, ø [mm]	L [cm]	H [cm]	EUR/buc.
620.230.00.1	12 / 10	16	12	6,8	3,5	7,72
620.240.00.1	12	16	15	6,9	3,6	7,72
620.231.00.1	15 / 12	20	15	6,9	3,6	9,96
620.241.00.1	15	20	18	6,9	3,6	9,96
620.242.00.1	15 / 20	20	22	7	3,7	9,96
620.232.00.1	20	25	22	7	3,7	13,82
620.233.00.1	25	32	28	7,7	4,1	18,82
620.234.00.1	32	40	35	8	4,4	22,11
620.235.00.1	40	50	42	12,8	6,9	49,75
620.236.00.1	50	63	54	13,8	7,5	77,37

Livrabil din April 2024

Nou

Adaptor Geberit FlowFit la Geberit Mapress, cu mufă de sertizare, din oțel inoxidabil

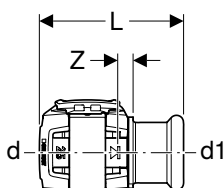

click & scan

Cod art.	DN	d, ø [mm]	d1, ø [mm]	L [cm]	Z [cm]	EUR/buc.
620.329.00.1	12 / 10	16	12	5,4	0,6	18,40
620.332.00.1	12	16	15	5,6	0,6	18,40
620.347.00.1	15 / 12	20	15	5,6	0,6	21,66
620.333.00.1	15	20	18	5,6	0,6	21,66
620.334.00.1	15 / 20	20	22	5,7	0,6	21,66
620.335.00.1	20	25	22	5,7	0,6	27,07
620.336.00.1	25	32	28	6,4	0,8	35,27
620.337.00.1	32	40	35	6,7	0,8	47,69
620.338.00.1	40	50	42	9,7	1,1	81,27
620.339.00.1	50	63	54	10,7	1,2	105,68

Livrabil din April 2024



Adaptor Geberit Mapress Oțel-Inox, cu filet exterior



click & scan
EUR/buc.

Cod art.	DN	d, ø [mm]	R ["]	L [cm]	H [cm]	EUR/buc.
31726	12 / 10	15	3/8"	3,8	1,8	13,48
31703	12 / 15	15	1/2"	4,1	2,1	13,48
31714	12 / 20	15	3/4"	4,3	2,3	13,48
31704	15	18	1/2"	4,2	2,2	14,80
31705	15 / 20	18	3/4"	4,4	2,4	14,80
31715	20 / 15	22	1/2"	4,2	2,1	18,05
31707	20	22	3/4"	4,4	2,3	18,05
31716	20 / 25	22	1"	4,6	2,5	18,05
31717	25 / 20	28	3/4"	4,6	2,3	25,60
31708	25	28	1"	4,8	2,3	25,60
31718	25 / 32	28	1 1/4"	4,8	2,5	25,60
31719	32 / 25	35	1"	5,1	2,5	42,13
31709	32	35	1 1/4"	5,3	2,7	42,13
31720	32 / 40	35	1 1/2"	5,3	2,7	42,13
31721	40 / 32	42	1 1/4"	5,7	2,7	54,19
31710	40	42	1 1/2"	5,7	2,7	54,19
31722	50 / 40	54	1 1/2"	8,3	4,8	60,86
31711	50	54	2"	8,9	5,4	60,86
31713	65	76,1	2 1/2"	11,9	7	276,99
31724	80	88,9	3"	13,7	7,7	414,18

Adaptor Geberit Mapress Oțel-Inox, cu filet exterior G

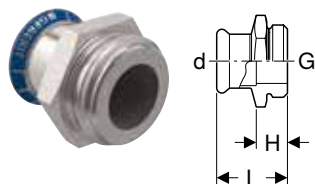

click & scan

Cod art.	DN	d, ø [mm]	G ["]	L [cm]	H [cm]	EUR/buc.
31731	12	15	3/4"	3,5	1,5	25,84
31732	15	18	3/4"	3,8	1,7	29,78
31733	20	22	1"	4	1,9	39,62
31738	N 25	28	1"	4,1	1,8	71,09
31734	25	28	1 1/4"	4,1	1,8	71,09
31735	32	35	1 1/2"	4,7	2,1	73,35
31736	40	42	1 3/4"	5,2	2,2	107,29
31737	50	54	2 3/8"	6,3	2,8	191,03

N: Nou, livrabil din April 2024

Adaptor Geberit Mapress Oțel-Inox, cu filet exterior NPT

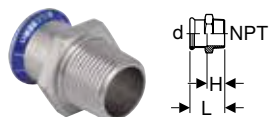

click & scan
EUR/buc.

Cod art.	DN	d, ø [mm]	NPT	L [cm]	H [cm]	EUR/buc.
31833	12 / 15	15	1/2"	4,8	2,8	14,24
31837	20	22	3/4"	4,9	2,8	19,61
31838	25	28	1"	5,6	3,1	30,18
31839	32	35	1 1/4"	6	3,4	40,64
31840	40	42	1 1/2"	6,5	3,5	61,70
31841	50	54	2"	7	3,5	135,48

Adaptor Geberit Mapress Oțel-Inox, cu filet exterior și capăt drept

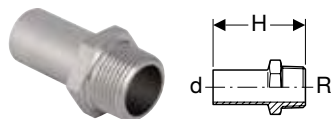

click & scan
EUR/buc.

Cod art.	DN	d, ø [mm]	R ["]	H [cm]	
31932	12 / 15	15	1/2"	5,7	13,48
31933	15	18	1/2"	5,7	14,80
31936	20	22	3/4"	5,9	18,05
31937	25	28	1"	6,6	25,60
31938	32	35	1 1/4"	8	42,13
31939	40	42	1 1/2"	9,1	54,19
31940	50	54	2"	10,2	60,86

Adaptor Geberit Mapress Oțel-Inox, cu filet interior

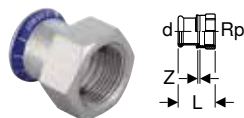

click & scan
EUR/buc.

Cod art.	DN	d, ø [mm]	Rp ["]	L [cm]	Z [cm]	
31801	12 / 10	15	3/8"	3,5	0,5	13,48
31802	12 / 15	15	1/2"	3,7	0,4	13,48
31823	12 / 20	15	3/4"	3,8	0,3	13,48
31803	15	18	1/2"	3,7	0,4	14,80
31804	15 / 20	18	3/4"	3,8	0,3	14,80
31805	20 / 15	22	1/2"	3,6	0,2	18,05
31806	20	22	3/4"	3,9	0,3	18,05
31824	20 / 25	22	1"	4,2	0,4	18,05
31807	25 / 15	28	1/2"	3,8	0,2	25,60
31819	25 / 20	28	3/4"	3,9	0,3	25,60
31809	25	28	1"	4,4	0,4	25,60
31825	25 / 32	28	1 1/4"	4,6	0,4	25,60
31820	32 / 25	35	1"	4,5	0,2	42,13
31811	32	35	1 1/4"	4,9	0,4	42,13
31826	32 / 40	35	1 1/2"	4,9	0,4	42,13
31821	40 / 32	42	1 1/4"	5,1	0,2	54,19
31814	40	42	1 1/2"	5,3	0,4	54,19
31822	50 / 40	54	1 1/2"	7,7	2,1	60,86
31818	50	54	2"	6,2	0,4	60,86

Adaptor Geberit Mapress Oțel-Inox, cu filet interior și capăt drept, lung

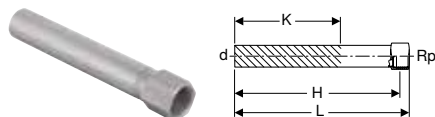

click & scan
EUR/buc.

Cod art.	DN	d, ø [mm]	Rp ["]	L [cm]	H [cm]	K [cm]	
90932	12 / 15	15	1/2"	14,8	13,5	9	13,48
90933	15	18	1/2"	14,8	13,5	9	14,80
90934	15 / 20	18	3/4"	15,2	13,3	9	14,80
90935	20 / 15	22	1/2"	14,8	13,9	8,9	18,05
90936	20	22	3/4"	15,2	13,7	8,7	18,05

Cot adaptor Geberit Mapress Oțel-Inox 90° cu filet exterior

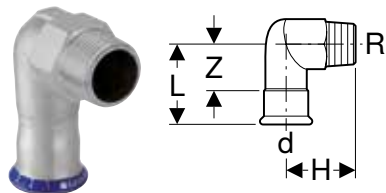

click & scan

Cod art.	DN	d, ø [mm]	R ["]	arc [°]	L [cm]	H [cm]	Z [cm]	EUR/buc.
33833	12 / 15	15	1/2"	90	5,7	3,7	3,7	19,08
33834	15	18	1/2"	90	5,7	3,9	3,7	20,39
33835	20	22	3/4"	90	6	4,6	3,9	26,31
33836	25	28	1"	90	6,7	5,4	4,4	33,55
33837	32	35	1 1/4"	90	7,5	6,3	4,9	47,68
33838	40	42	1 1/2"	90	8,3	6,7	5,3	83,83
33839	50	54	2"	90	9,4	7,8	5,9	106,84

Cot adaptor Geberit Mapress Oțel-Inox 90° cu filet interior

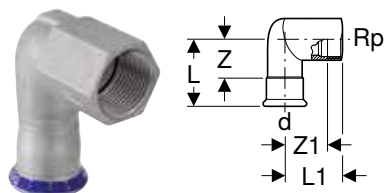

click & scan

Cod art.	DN	d, ø [mm]	Rp ["]	arc [°]	L [cm]	L1 [cm]	Z [cm]	Z1 [cm]	EUR/buc.
33802	12 / 10	15	3/8"	90	5,7	3,4	3,7	2,4	17,95
33803	12 / 15	15	1/2"	90	5,7	3,7	3,7	2,4	19,08
33804	15	18	1/2"	90	5,7	3,9	3,7	2,6	20,39
33808	20 / 15	22	1/2"	90	5,8	3,9	3,7	2,4	26,31
33805	20	22	3/4"	90	6	4,6	3,9	3,1	26,31
33806	25	28	1"	90	6,7	5,4	4,3	3,7	33,55
33807	32	35	1 1/4"	90	7,5	6,3	4,9	4,4	47,68

Accesorii

- Dispozitiv de fixare pentru cot adaptor Geberit Mapress 90° → p. 200

Cot adaptor Geberit Mapress Oțel-Inox 90° cu filet interior și capăt drept

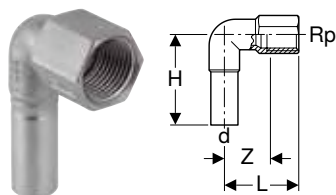

click & scan

Cod art.	DN	d, ø [mm]	Rp ["]	arc [°]	L [cm]	H [cm]	Z [cm]	EUR/buc.
33203	12 / 15	15	1/2"	90	3,6	5,3	2,3	19,08

Accesorii

- Dispozitiv de fixare pentru cot adaptor Geberit Mapress 90° → p. 200

Adaptoare și conexiuni, cu posibilitate de desfacere

Îmbinare filetată Geberit Mapress Oțel-Inox



click & scan
EUR/buc.

Cod art.	DN	d, ø [mm]	G ["]	L [cm]	Z [cm]	EUR/buc.
35320	12	15	3/4"	6,6	2,6	46,66
35321	15	18	3/4"	6,9	2,9	53,13
35322	20	22	1"	7,2	3	65,73
35323	25	28	1 1/4"	7,7	3,1	100,67
35324	32	35	1 1/2"	8,2	3	105,26
35325	40	42	1 3/4"	9,5	3,5	151,60
35326	50	54	2 3/8"	11,3	4,3	256,55

Îmbinare filetată Geberit Mapress Oțel-Inox, cu piuliță din oțel CrNi



click & scan
EUR/buc.

Cod art.	DN	d, ø [mm]	G ["]	L [cm]	Z [cm]	EUR/buc.
35390	12	15	3/4"	6,6	2,6	55,92
35391	15	18	3/4"	6,9	2,9	63,75
35392	20	22	1"	7,2	3	78,89
35393	25	28	1 1/4"	7,7	3,1	120,78
35394	32	35	1 1/2"	8,2	3	126,36
35395	40	42	1 3/4"	9,5	3,5	181,89
35396	50	54	2 3/8"	11,3	4,3	301,84

Adaptor Geberit Mapress Oțel-Inox, cu piuliță

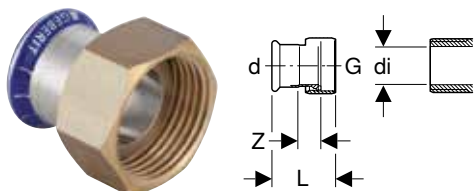

click & scan

Cod art.	DN	d, ø [mm]	G ["]	di, ø [mm]	L [cm]	Z [cm]	EUR/buc.
35042	12	15	1/2"	10	5,1	2,5	16,27
35032	12 / 20	15	3/4"	13	3,7	1,1	16,27
35072	12	15	1 1/4"	26	4,3	1,3	16,27
35033	15 / 20	18	3/4"	13	3,7	1,1	20,92
35034	20 / 25	22	1"	20	4	1,1	23,52
35044	20	22	1 1/4"	26	4,3	1,3	23,52
35045	20	22	1 1/2"	32	4,4	1,3	23,52
35046	25	28	1"	20	5,5	2,4	30,62
35035	25 / 32	28	1 1/4"	26	4,4	1,3	30,62
35047	25 / 40	28	1 1/2"	32	4,6	1,3	30,62
35036	32 / 40	35	1 1/2"	32	4,8	1,3	34,66
35037	40	42	1 3/4"	39	5,2	1,3	47,02
35038	50 / 60	54	2 3/8"	51	5,8	1,5	63,32
35039	65 / 80	76,1	3"	73	9,9	3,3	249,85
35040	80 / 90	88,9	3 1/2"	84	11,1	3,7	322,14

Adaptor Geberit Mapress Oțel-Inox, cu piuliță din oțel CrNi

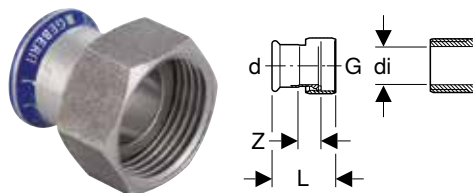

click & scan

Cod art.	DN	d, ø [mm]	G ["]	di, ø [mm]	L [cm]	Z [cm]	EUR/buc.
35132	12	15	3/4"	13	3,7	1,1	21,41
35133	15	18	3/4"	13	3,7	1,2	25,21
35134	20	22	1"	20	4	1,1	27,17
35075	25	28	1 1/2"	32	4,4	1,3	60,86

Adaptor cu filet Geberit Mapress Oțel-Inox, cu filet exterior



click & scan

Cod art.	DN	d, ø [mm]	R ["]	G ["]	L [cm]	H [cm]	EUR/buc.
35330	12 / 15	15	1/2"	3/4"	6,4	4,4	23,14
35331	12 / 20	15	3/4"	3/4"	6,6	4,6	23,14
35332	15	18	1/2"	3/4"	6,4	4,4	26,50
35333	15 / 20	18	3/4"	3/4"	6,6	4,6	26,50
35334	20 / 15	22	1/2"	1"	6,7	4,6	27,64
35335	20	22	3/4"	1"	6,8	4,7	27,64
35336	20 / 25	22	1"	1"	7,3	5,2	27,64
35337	25	28	1"	1 1/4"	7,8	5,5	40,83
35338	32	35	1 1/4"	1 1/2"	8,5	5,9	51,24
35339	40	42	1 1/2"	1 3/4"	9	6	72,25
35340	50	54	2"	2 3/8"	10,3	6,8	129,48

Adaptor cu filet Geberit Mapress Oțel-Inox, cu filet exterior, piuliță din oțel CrNi



click & scan

Cod art.	DN	d, ø [mm]	R ["]	G ["]	L [cm]	H [cm]	EUR/buc.
35360	12 / 15	15	1/2"	3/4"	6,4	4,4	30,62
35361	12 / 20	15	3/4"	3/4"	6,6	4,6	30,62
35362	15	18	1/2"	3/4"	6,4	4,4	34,53
35363	15 / 20	18	3/4"	3/4"	6,6	4,6	34,53
35364	20 / 15	22	1/2"	1"	6,7	4,6	36,07
35365	20	22	3/4"	1"	6,8	4,7	36,07
35366	20 / 25	22	1"	1"	7,3	5,2	36,07
35367	25	28	1"	1 1/4"	7,8	5,5	50,97
35368	32	35	1 1/4"	1 1/2"	8,5	5,9	67,37
35369	40	42	1 1/2"	1 3/4"	9	6	87,12
35370	50	54	2"	2 3/8"	10,3	6,8	162,56

Adaptor cu filet Geberit Mapress Oțel-Inox, cu filet exterior și capăt drept

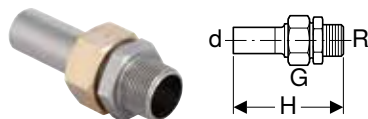

click & scan

EUR/buc.

Cod art.	DN	d, ø [mm]	R ["]	G ["]	H [cm]	EUR/buc.
35400	12 / 15	15	1/2"	3/4"	8,6	30,62
35402	15	18	1/2"	3/4"	8,6	34,53
35405	20	22	3/4"	1"	9,2	36,07
35407	25	28	1"	1 1/4"	10,1	50,97
35408	32	35	1 1/4"	1 1/2"	10,9	67,37
35409	40	42	1 1/2"	1 3/4"	11,5	87,12
35410	50	54	2"	2 3/8"	12,9	162,56

Adaptor cu filet Geberit Mapress Oțel-Inox, cu filet interior



click & scan

EUR/buc.

Cod art.	DN	d, ø [mm]	Rp ["]	G ["]	L [cm]	Z [cm]	EUR/buc.
35300	12 / 15	15	1/2"	3/4"	5,9	2,6	23,14
35301	12 / 20	15	3/4"	3/4"	6,1	2,6	25,30
35302	15	18	1/2"	3/4"	5,9	2,6	26,50
35303	15 / 20	18	3/4"	3/4"	6,1	2,6	26,50
35304	20	22	3/4"	1"	6,3	2,7	27,64
35305	20 / 25	22	1"	1"	6,6	2,8	27,64
35306	25	28	1"	1 1/4"	7,1	3,1	40,83
35307	32	35	1 1/4"	1 1/2"	7,7	3,2	51,24
35308	40	42	1 1/2"	1 3/4"	8,2	3,3	63,96
35309	50	54	2"	2 3/8"	9,5	3,7	119,00

Adaptor cu filet Geberit Mapress Oțel-Inox, cu filet interior, piuliță din oțel CrNi



click & scan

EUR/buc.

Cod art.	DN	d, ø [mm]	Rp ["]	G ["]	L [cm]	Z [cm]	EUR/buc.
35350	12 / 15	15	1/2"	3/4"	5,9	2,6	30,62
35357	12 / 20	15	3/4"	3/4"	6,1	2,6	30,62
35351	15	18	1/2"	3/4"	5,9	2,6	34,53
35358	15 / 20	18	3/4"	3/4"	6,1	2,6	34,53
35352	20	22	3/4"	1"	6,3	2,7	36,07
35359	20 / 25	22	1"	1"	6,6	2,8	36,07
35353	25	28	1"	1 1/4"	7,1	3,1	50,97
35354	32	35	1 1/4"	1 1/2"	7,7	3,2	67,37
35355	40	42	1 1/2"	1 3/4"	8,2	3,3	87,12
35356	50	54	2"	2 3/8"	9,5	3,7	162,56

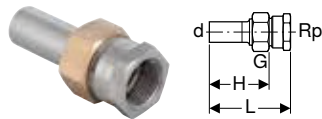

Adaptor cu filet Geberit Mapress Oțel-Inox, cu filet interior și capăt drept

[click & scan](#)
 EUR/buc.

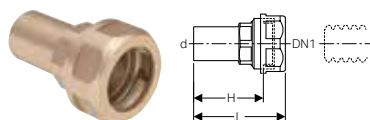
Cod art.	DN	d, ø [mm]	Rp ["]	G ["]	L [cm]	H [cm]	EUR/buc.
35380	12 / 15	15	1/2"	3/4"	8,1	5,9	30,62
35382	15	18	1/2"	3/4"	8,1	5,9	34,53
35384	20	22	3/4"	1"	8,7	6,4	36,07
35386	25	28	1"	1 1/4"	9,4	6,7	50,97
35387	32	35	1 1/4"	1 1/2"	10,1	7,2	67,37
35388	40	42	1 1/2"	1 3/4"	10,7	7,7	87,12
35389	50	54	2"	2 3/8"	12	8,4	156,15

Adaptor Geberit Mapress cu îmbinare filetată inelară de fixare pentru tuburi ondulate, apă nepotabilă, capăt drept

[click & scan](#)
 EUR/buc.

Cod art.	DN	DN1	d, ø [mm]	L [cm]	H [cm]	PN [bar]	EUR/buc.
22421	12	16	15	6,4	4,9	10	16,93
22431	12	20	15	6,7	5,2	10	19,77
22422	15	16	18	6,4	4,9	10	18,35
22432	15	20	18	6,7	5,2	10	21,23
22423	20	16	22	6,8	5,9	10	19,77
22433	20	20	22	6,8	5,9	10	22,60
22444	25	25	28	6,8	5,9	10	31,05

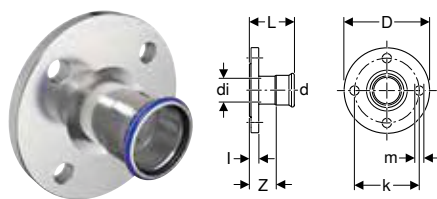

- În cazul unor presiuni de exploatare diferite pentru îmbinarea filetată și țeava ondulată trebuie luată în considerație presiunea de exploatare mai mică.

Flanșă Geberit Mapress Oțel-Inox PN 10/16, cu mufă de sertizare

[click & scan](#)

Cod art.	DN	d, ø [mm]	di, ø [mm]	D [cm]	k [mm]	m [mm]	L [cm]	l [cm]	Z [cm]	n [pc.]	PN [bar]	EUR/buc.
33732	15 / 12	15	15	9,5	65	14	6,1	1,6	4,1	4	10 / 16	41,47
33733	15	18	15	9,5	65	14	6,2	1,6	4,2	4	10 / 16	45,57
33734	20	22	19	10,5	75	14	6,5	1,8	4,4	4	10 / 16	53,93
33735	25	28	25	11,5	85	14	6,9	1,8	4,6	4	10 / 16	65,78
33736	32	35	32	14	100	18	7,2	1,8	4,6	4	10 / 16	94,68
33737	40	42	39	15	110	18	7,9	1,8	4,9	4	10 / 16	110,45
33738	50	54	51	16,5	125	18	8,7	1,8	5,2	4	10 / 16	136,74
33739	65	76,1	72	18,5	145	18	11,8	1,8	6,5	4	10 / 16	219,93
33740	80	88,9	84,8	20	160	18	12,5	2	6,5	8	10 / 16	252,48
33741	100	108	103,9	22	180	18	13	2	5,5	8	10 / 16	302,39

Accesorii

- Set șurub Geberit pentru conexiune cu flanșă, din oțel CrNi → p. 158
- Garnitură flanșă Geberit PN 10/16, din fibre compozite → p. 157

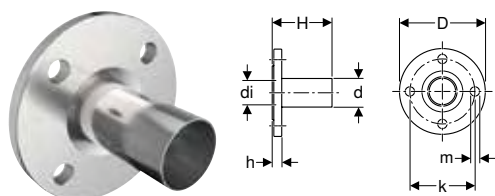
Flanșă Geberit Mapress Oțel-Inox PN 10/16, cu capăt drept



click & scan

Cod art.	DN	d, \emptyset [mm]	di, \emptyset [mm]	D [cm]	k [mm]	m [mm]	H [cm]	h [cm]	n [pc.]	PN [bar]	EUR/buc.
33744	20	22	19	10,5	75	14	7,9	1,8	4	10 / 16	53,92
33745	25	28	25	11,5	85	14	8,1	1,8	4	10 / 16	65,78
33746	32	35	32	14	100	18	9	1,8	4	10 / 16	94,68
33747	40	42	39	15	110	18	10,8	1,8	4	10 / 16	110,43
33748	50	54	51	16,5	125	18	11,3	1,8	4	10 / 16	136,74
33749	65	76,1	72	18,5	145	18	13,6	1,8	4	10 / 16	215,61
33750	80	88,9	84,8	20	160	18	15,2	2	8	10 / 16	252,48
33752	100	108	103,9	22	180	18	16,5	2	8	10 / 16	302,39

Accesorii

- Set șurub Geberit pentru conexiune cu flanșă, din oțel CrNi → p. 158
- Garnitură flanșă Geberit PN 10/16, din fibre compozite → p. 157

Colier Geberit Mapress Oțel-Inox cu capăt drept, pentru flanșă liberă PN 6

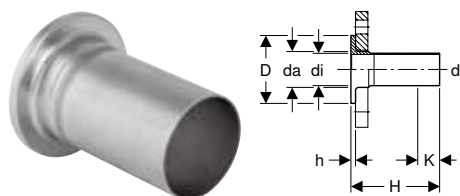

click & scan

Cod art.	DN	d, \emptyset [mm]	da [mm]	di, \emptyset [mm]	D [cm]	H [cm]	h [cm]	K [cm]	PN [bar]	EUR/buc.
36150	25	28	32	25,6	6	13,5	0,6	3,7	6	70,40
36151	32	35	40	32	7	13,5	0,6	2,7	6	100,72
36152	40	42	47	39	8	13,5	0,6	0	6	117,64
36153	50	54	59	51	9	13,5	0,8	0	6	145,47
36154	65	76,1	78	73,1	11	13,5	0,8	0	6	228,90
36155	80	88,9	91	84,9	12,8	13,5	1	0	6	268,08
36156	100	108	110	104	14,8	13,5	1	0	6	321,28

De comandat suplimentar

- Flanșă liberă

Accesorii

- Garnitură flanșă Geberit PN 6, din fibre compozite → p. 158



Colier Geberit Mapress Oțel-Inox cu capăt drept, pentru flanșă liberă PN 10/16

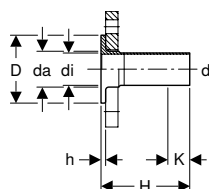

click & scan

Cod art.	DN	d, ø [mm]	da [mm]	di, ø [mm]	D [cm]	H [cm]	h [cm]	K [cm]	PN [bar]	EUR/buc.
36141	20	22	27	19,6	5,8	13,5	0,6	3,5	10 / 16	57,88
36142	25	28	32	25,6	6,8	13,5	0,6	3,7	10 / 16	70,40
36143	32	35	40	32	7,8	13,5	0,6	2,5	10 / 16	100,72
36144	40	42	47	39	8,8	13,5	0,6	0	10 / 16	117,64
36145	50	54	59	51	10,2	13,5	0,8	0	10 / 16	145,47
36146	65	76,1	78	72,1	12,2	13,5	0,8	0	10 / 16	228,90
36147	80	88,9	91	84,9	13,8	13,5	1	0	10 / 16	268,08
36148	100	108	110	104	15,8	13,5	1	0	10 / 16	321,28

De comandat suplimentar

- Flanșă liberă

Accesorii

- Garnitură flanșă Geberit PN 10/16, din fibre compozite → p. 157

Compensatoare

Compensator axial Geberit Mapress Oțel-Inox, cu mufe de sertizare

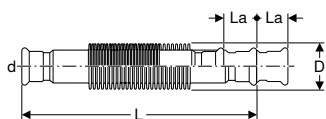

click & scan

Cod art.	DN	d, ø [mm]	D [cm]	La [mm]	L [cm]	Z [cm]	EUR/buc.
33932	12	15	2,6	7	15,1	11,1	104,88
33933	15	18	2,6	7	14,7	10,7	110,77
33934	20	22	3,1	11	10,6	6,4	130,49
33935	25	28	3,9	13	12	7,4	140,93
33936	32	35	4,6	13	13,9	8,7	158,44
33937	40	42	5,9	13	14,9	8,9	279,00
33938	50	54	7	18	17,6	10,6	302,78
33939	65	76,1	8,8	22	26,2	15,6	376,31
33940	80	88,9	11,7	23	28,6	16,6	444,24
33941	100	108	14,4	23	54,2	39,2	902,55

Treceri

Elemente de trecere prin plafon și perete despărțitor Geberit Mapress Oțel-Inox, cu două capete drepte

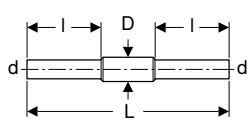

click & scan

Cod art.	DN	d, ø [mm]	D [cm]	L [cm]	l [cm]	EUR/buc.
90980	12	15	2,5	45	16,5	57,22
90981	15	18	3	45	16,5	64,84
90982	20	22	3,4	45	16,5	67,95
90983	25	28	3,8	45	16,5	81,30
90984	32	35	4,5	45	16,5	93,34
90985	40	42	5,4	45	16,5	107,48
90986	50	54	7	45	16,5	118,57
90987	65	76,1	8,9	45	16,5	268,70
90988	80	88,9	10,8	45	16,5	300,27
90989	100	108	13,3	45	16,5	331,90

Dispozitive de închidere

Capac Geberit Mapress Oțel-Inox



click & scan
EUR/buc.

Cod art.	DN	d, ø [mm]	L [cm]	Z [cm]	EUR/buc.
33212	12	15	2,3	0,3	9,91
33213	15	18	2,3	0,3	11,84
33214	20	22	2,4	0,3	12,87
33215	25	28	2,6	0,3	14,80
33216	32	35	2,9	0,3	21,08
33217	40	42	3,3	0,3	44,41
33218	50	54	3,8	0,3	50,00
33219	65	76,1	6	0,7	60,90
33220	80	88,9	6,7	0,7	67,62
33221	100	108	8,2	0,7	75,25

Racorduri

Cot de racordare Geberit Mapress Oțel-Inox 90°

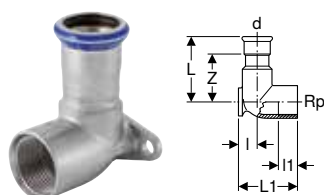

click & scan

Cod art.	DN	d, ø [mm]	Rp ["]	arc [°]	L [cm]	l [cm]	l1 [cm]	Z [cm]	EUR/buc.
L1 / lungime: 4,3 cm									
33403	12 / 15	15	1/2"	90	5	1,3	1,5	3	23,29
33405	15	18	1/2"	90	5	1,3	1,5	3	25,02
L1 / lungime: 5,1 cm									
33407	20	22	3/4"	90	5,4	1,7	1,6	3,3	32,78

Cot de racordare Geberit Mapress Oțel-Inox 90°, montat

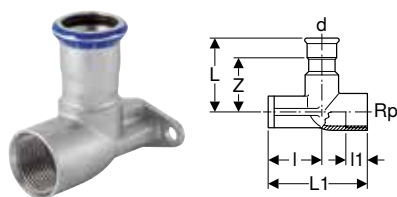

click & scan

Cod art.	DN	d, ø [mm]	Rp ["]	arc [°]	L [cm]	l [cm]	l1 [cm]	Z [cm]	EUR/buc.
L1 / lungime: 6,5 cm									
33423	12 / 15	15	1/2"	90	5	3,5	1,5	3	23,29
33425	15	18	1/2"	90	5	3,5	1,5	3	25,02
33427	20	22	3/4"	90	5,4	3,1	1,6	3,3	32,78

Accesorii pentru Geberit Mapress Oțel-Inox

Izolații pentru racorduri

Suport fonoizolant Geberit pentru cot de conectare 90° simplu



click & scan
EUR/buc.

Cod art.

601.806.00.1

2,67

Set fonoizolant Geberit pentru cot de conectare 90° simplu

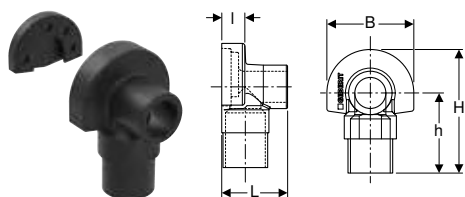

click & scan

Cod art.

	L [cm]	I [cm]	B [cm]	H [cm]	h [cm]	EUR/buc.
601.801.00.1	5,3	1,9	7	10	6,5	3,03

Etanșări pentru țevi și fittinguri

Bandă de etanșare Geberit

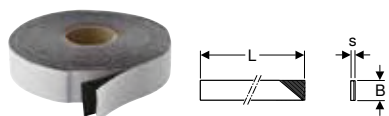

click & scan
EUR/buc.

Cod art.

	s [mm]	L [m]	B [cm]	EUR/buc.
601.813.00.1	1	12,5	3	31,41
601.815.00.1	1	12,5	5	52,06



- Montare după încercare la presiune

Dispozitive de fixare pentru țevi

Brățară pentru conductă Geberit, izolată, cu piuliță conector M8 / M10

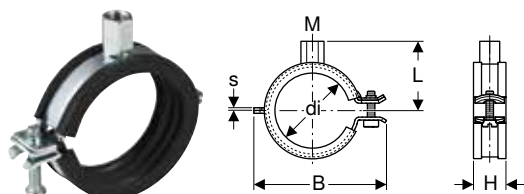

click & scan

Cod art.	Culoare/suprafață	M [mm]	di, ø [mm]	L [cm]	B [cm]	H [cm]	EUR/buc.
601.851.26.1	Galvanizat	8 / 10	15-19	3,1	5,2	2,3	1,75
601.852.26.1	Galvanizat	8 / 10	20-24	3,4	5,6	2,3	1,75
601.853.26.1	Galvanizat	8 / 10	25-30	3,6	6,3	2,3	1,86
601.854.26.1	Galvanizat	8 / 10	32-37	3,9	6,8	2,3	2,00
601.855.26.1	Galvanizat	8 / 10	40-46	4,3	7,6	2,3	2,12
601.857.26.1	Galvanizat	8 / 10	54-58	4,8	8,9	2,3	2,61

Cod art.	Culoare/suprafață	M [mm]	di, ø [mm]	L [cm]	B [cm]	H [cm]	EUR/buc.
601.859.26.1	Galvanizat	8 / 10	74-80	6,4	11,9	2,3	3,61
601.860.26.1	Galvanizat	8 / 10	83-91	6,8	13	2,3	3,74
601.861.26.1	Galvanizat	8 / 10	108-114	8,1	15,3	2,8	4,23

Niplu dublu Geberit M10 / G 1/2"

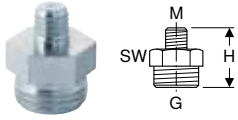

click & scan
EUR/buc.

Cod art.	Culoare/suprafață	G [""]	M [mm]	H [cm]	SW [mm]	EUR/buc.
362.856.26.1	Galvanizat	1/2"	10	2,8	22	5,60

Tijă filetată Geberit

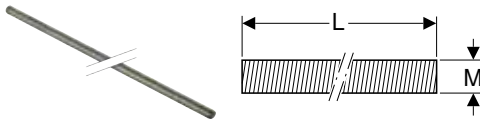

click & scan
EUR/buc.

Cod art.	Culoare/suprafață	M [mm]	L [cm]	EUR/buc.
362.834.26.1	Galvanizat	10	200	6,83

Țeavă filetată Geberit

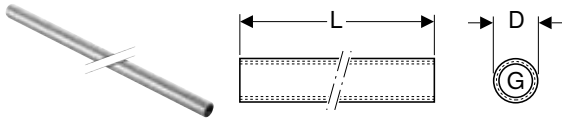

click & scan
EUR/buc.

Cod art.	G [""]	D [cm]	L [cm]	EUR/buc.
362.857.26.1	1/2"	2,5	115	38,24

Placă de fixare Geberit dreptunghiulară, două orificii, cu piuliță conector M8/M10

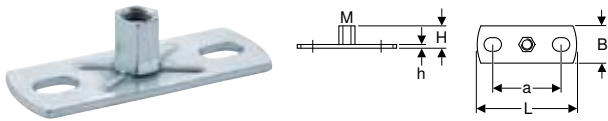

click & scan
EUR/buc.

Cod art.	M [mm]	a [cm]	L [cm]	B [cm]	H [cm]	h [cm]	EUR/buc.
362.848.26.1	8 / 10	5,4	8	3	1,9	0,3	3,81

Placă de fixare Geberit dreptunghiulară, două orificii, cu piuliță conector M10/G 1/2"

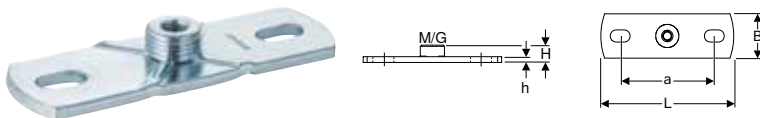

click & scan
EUR/buc.

Cod art.	G [""]	M [mm]	a [cm]	L [cm]	B [cm]	H [cm]	h [cm]	EUR/buc.
362.851.26.1	1/2"	10	8,5	12	4	1,5	0,5	4,68

Dispozitive de fixare pentru racorduri

Dispozitiv de fixare pentru cot adaptor Geberit Mapress 90°

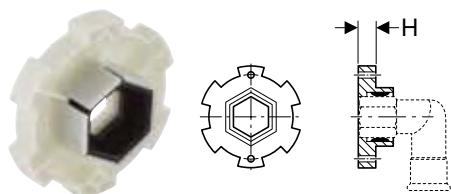

click & scan

Cod art.	H [cm]	EUR/buc.
90282	1,3	6,81

Placă de montaj Geberit, cu decalaj, simplă, pentru sistemul de alimentare



click & scan

Cod art.	EUR/buc.
601.733.00.1	5,69

Placă de montaj Geberit, montată, dublă, distanță de racordare 10 cm sau 12 cm



click & scan

Cod art.	AD [cm]	AD1 [cm]	EUR/buc.
601.731.00.1	12	10	7,17

Accesorii

- Brațară pentru conductă de evacuare Geberit pentru plăci de montaj → p. 156

Placă de montaj Geberit, montată, dublă, distanță de racordare 7,3 cm sau 15,3 cm

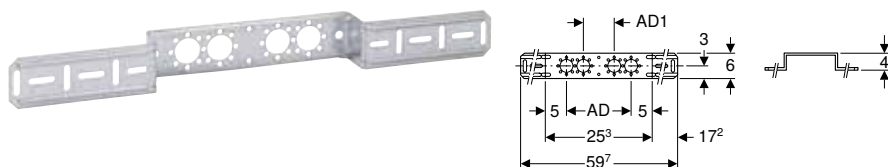

click & scan

Cod art.	AD [cm]	AD1 [cm]	EUR/buc.
601.732.00.1	15,3	7,3	7,17

Accesorii

- Brațară pentru conductă de evacuare Geberit pentru plăci de montaj → p. 156

Brățară pentru conductă de evacuare Geberit pentru plăci de montaj

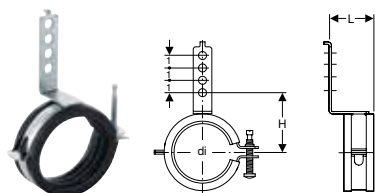

click & scan

Cod art.	Culoare/suprafață	di, \emptyset [mm]	L [cm]	H [cm]	EUR/buc.
601.741.00.1	Galvanizat	50-56	3,6	5,2-5,5	5,56

Garnituri de sistem

O-ring Geberit Mapress CIIR negru



click & scan

Cod art.	DN	d, \emptyset [mm]	EUR/buc.
90401	10	12	0,34
90402	12	15	0,36
90403	15	18	0,47
90404	20	22	0,47
90405	25	28	0,55
90406	32	35	0,55
90407	40	42	0,84
90408	50	54	0,84
90409	65	76,1	2,40
90410	80	88,9	3,27
90411	100	108	6,29

O-ring Geberit Mapress FKM albastru



click & scan

Cod art.	DN	d, \emptyset [mm]	EUR/buc.
90881	10	12	2,43
90882	12	15	1,02
90883	15	18	1,24
90884	20	22	1,55
90885	25	28	1,84
90886	32	35	2,14
90887	40	42	3,82
90888	50	54	5,38
90891	65	76,1	15,71
90892	80	88,9	19,73
90893	100	108	43,93



O-ring Geberit Mapress FKM alb



click & scan

Cod art.	DN	d, ø [mm]	EUR/buc.
91152	12	15	1,53
91153	15	18	1,66
91154	20	22	1,92
91155	25	28	2,35
91156	32	35	2,96
91157	40	42	5,14
91158	50	54	6,98
91159	65	76,1	24,93
91160	80	88,9	34,90
91161	100	108	59,60

Garnitură plată Geberit Mapress EPDM neagră

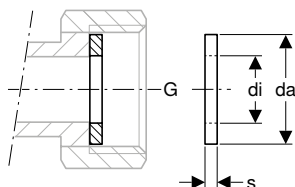

click & scan

Cod art.	G ["]	da [mm]	di, ø [mm]	s [mm]	EUR/buc.
90081	3/4"	24	13	2	1,92
90082	1"	30	19,6	2	1,92
90083	1 1/4"	39	25,6	2	1,92
90084	1 1/2"	45	32	2	1,92
90085	1 3/4"	50	39	2	1,92
90086	2 3/8"	66	51	3	1,92
90088	N 3"	84,7	76	3	2,40
90089	N 3 1/2"	97	84	3	2,89

N: Nou, livrabil din April 2024

Garnitură plată Geberit Mapress FPM verde

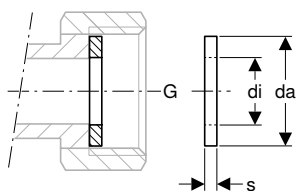

click & scan

Cod art.	G ["]	da [mm]	di, ø [mm]	s [mm]	EUR/buc.
90092	3/4"	24	13	2	2,01
90094	1"	30	19,6	2	3,03
90095	1 1/4"	39	25,6	2	3,03
90096	1 1/2"	45	32	2	3,96
90097	1 3/4"	50	39	2	3,96
90098	2 3/8"	66	51	2	10,35

Nou

Garnitură plată Geberit Mapress, din fibre compozite



click & scan
 EUR/buc.

Cod art.	G ["]	da [mm]	di, ø [mm]	s [mm]	
600.079.00.1	1/2"	18,4	10	2	1,11
600.080.00.1	3/4"	23,9	13	2	1,34
600.081.00.1	1"	30	19,6	2	1,47
600.082.00.1	1 1/8"	34,7	21	2	1,56
600.083.00.1	1 1/4"	38	25	2	1,78
600.084.00.1	1 1/4"	38,7	25,6	2	1,78
600.085.00.1	1 1/2"	44,6	32	2	1,93
600.087.00.1	1 3/4"	50,5	39	2	2,11
600.088.00.1	2"	56,4	42	2	2,22
600.089.00.1	2 1/4"	62,5	42	2	2,33
600.090.00.1	2 3/8"	66,2	51	2	2,67
600.091.00.1	2 1/2"	72	54	2	3,00
600.092.00.1	2 3/4"	78,3	57	2	3,33
600.093.00.1	3"	84,7	72,1	2	3,66
600.094.00.1	3 1/2"	97,1	84,9	2	4,00

Livrabil din April 2024



- Produs înlocuitor pentru cod art. 90072, 90074, 90075, 90076, 90077, 90078

Nou

Garnitură flanșă Geberit PN 6, din fibre compozite



click & scan
 EUR/buc.

Cod art.	DN	da [mm]	di, ø [mm]	s [mm]	PN [bar]	
600.051.00.1	15	44	20	2	6	1,67
600.052.00.1	20	54	25	2	6	1,87
600.053.00.1	25	64	30	2	6	2,22
600.054.00.1	32	76	38	2	6	2,64
600.055.00.1	40	86	45	2	6	3,15
600.056.00.1	50	96	57	2	6	3,73
600.057.00.1	65	116	76	2	6	4,68
600.058.00.1	80	132	89	2	6	5,61
600.059.00.1	100	152	108	2	6	6,72

Livrabil din April 2024



- Produs înlocuitor pentru cod art. 91041, 91042, 91043, 91044, 91045, 91046, 91047, 91048, 91049

Nou

Garnitură flanșă Geberit PN 10/16, din fibre compozite



click & scan
EUR/buc.

Cod art.	DN	da [mm]	di, ø [mm]	s [mm]	PN [bar]	
600.041.00.1	15	50	20	2	10 / 16	1,89
600.044.00.1	32	82	38	2	10 / 16	2,98
600.045.00.1	40	92	45	2	10 / 16	3,55
600.046.00.1	50	107	57	2	10 / 16	4,22
600.047.00.1	65	127	76	2	10 / 16	5,28
600.048.00.1	80	142	89	2	10 / 16	6,34
600.049.00.1	100	162	108	2	10 / 16	7,61

Livrabil din April 2024



- Produs înlocuitor pentru cod art. 91031, 91032, 91033, 91034, 91035, 91036, 91037, 91038, 91039

Seturi de șuruburi pentru conexiuni cu flanșă

Set șurub Geberit pentru conexiune cu flanșă, din oțel CrNi

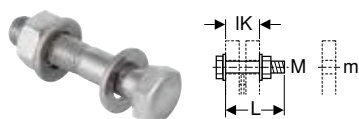

click & scan
EUR/buc.

Cod art.	M [mm]	m [mm]	L [cm]	IK [cm]	
91164	10	11	4,5	3,1	4,80
91165	10	11	5	3,6	4,80
91166	12	14	5	3	6,32
91167	12	14	5,5	3,5	6,32
91168	12	14	6	4	6,32
91169	16	18	5,5	3,3	9,45
91170	16	18	6	3,8	9,45
91171	16	18	6,5	4,3	9,45
91172	16	18	7	4,8	9,45
91173	16	18	8	5,8	9,45





Geberit Mapress Oțel-Carbon

Vedere de ansamblu asupra utilizărilor – Geberit Mapress Oțel carbon.....	209
Geberit Mapress Oțel-Carbon	210
Țevi 1.0034.....	210
Țevi 1.0215.....	211
Mufe	211
Reducții.....	212
Coturi	213
Teuri	215
Elemente în cruce	218
Adaptoare, fără posibilitate de desfacere.....	219
Adaptoare și conexiuni, cu posibilitate de desfacere.....	223
Compensatoare.....	226
Dispozitive de închidere	226
Teuri pentru instalații de încălzire	227
Racorduri pentru instalații de încălzire	227
Accesorii pentru Geberit Mapress Oțel-Carbon	229
Etanșări pentru țevi și fittinguri	229
Dispozitive de fixare pentru țevi	229
Dispozitive de fixare pentru racorduri.....	230
Garnituri de sistem	231
Seturi de șuruburi pentru conexiuni cu flanșă.....	234



Vedere de ansamblu asupra utilizărilor – Geberit Mapress Oțel carbon

Geberit România, Versiune: December 2023

Domenii de utilizare	Temperatură de operare	Presiunea maximă de exploatare	Țevi		
			Oțel carbon galvanizat la exterior	Oțel carbon cu înveliș din PP	Oțel carbon galvanizat la interior și exterior
Medii fluide					
Pentru apă de răcire și de încălzire fără antigel	0–100 °C	16 bar / 1600 kPa	✓ ⁸⁾	✓ ⁸⁾	
Pentru apă de răcire și de încălzire fără antigel	-30 – +120 °C ³⁾	16 bar / 1600 kPa	✓ ⁸⁾	✓ ⁸⁾	
Pentru agent termic de termoficare ≤ 120 °C	0–120 °C	16 bar / 1600 kPa	✓ ⁸⁾		
Pentru agent termic de termoficare ≤ 140 °C	0–140 °C	16 bar / 1600 kPa	✓ ⁸⁾		
Pentru apă pentru stingerea incendiilor (umed)	0–100 °C	16 bar / 1600 kPa			✓
Pentru sprinklere (umed)	0–100 °C	16 / 12 / 10 bar 1600 / 1200 / 1000 kPa ⁶⁾			✓
Pentru agenți termici (solar)	-25 – +220 °C ⁴⁾⁵⁾	10 bar / 1000 kPa	✓ ⁸⁾		
Pentru uleiuri minerale și de lubrifiere	La cerere	La cerere	9)		
Pentru combustibili (de ex. diesel)	La cerere	La cerere	9)		
Medii gazoase					
Pentru aer comprimat (clasă de puritate ulei 2-3) ¹⁾	0–100 °C	25 / 16 / 12 bar 2500 / 1600 / 1200 kPa ⁷⁾			✓
Pentru aer comprimat (clasa de puritate pentru ulei 3-X) ²⁾	0–100 °C	25 / 16 / 12 bar 2500 / 1600 / 1200 kPa ⁷⁾			✓

✓ Utilizare generală aprobată, dacă sunt îndeplinite condițiile suplimentare definite conform notelor de subsol

¹⁾ Clasă de puritate ulei conform ISO 8573-1:2010E; pentru detalii privind umiditatea și particulele, consultați informațiile tehnice "Sisteme de conducte Geberit pentru instalații de aer comprimat"

²⁾ Clasa de puritate ulei conform ISO 8573-1:2010E; pentru detalii privind umiditatea și particulele, vezi informațiile tehnice "Sisteme de conducte Geberit pentru instalații de aer comprimat"

³⁾ Utilizarea inhibitorilor, a agenților de protecție împotriva coroziunii, a agenților de protecție la îngheț numai după aprobarea Geberit

⁴⁾ Durată de viață cu colectorul oprit: 200 h/a la 180 °C; 60 h/a la 200 °C; total 500 h/durată de viață la 220 °C

⁵⁾ Utilizarea inhibitorilor, a agenților de protecție împotriva coroziunii, a agenților de protecție la îngheț numai după aprobarea Geberit

⁶⁾ 16 bar / 1600 kPa pentru d22–54mm, 12 bar / 1200 kPa pentru d66.7–76.1mm, 10 bar / 1000 kPa pentru d88.9–108mm

⁷⁾ 25 bar / 2500 kPa pentru d12–28mm, 16 bar / 1600 kPa pentru d35–54mm, 12 bar / 1200 kPa pentru d66.7–108mm

⁸⁾ Doar sisteme închise

⁹⁾ Following Geberit approval



- Pentru fiecare aplicație se vor respecta condițiile de utilizare din autorizațiile de referință, norme și reglementări tehnice. Ele pot diferi de datele specificate

	Fitinguri		Inele de etanșare		Garnituri plate pentru îmbinări filetate			Garnituri de flanșă
	Indicator roșu din oțel C	Alamă indicator alb	CIIR negru	FKM albastru	EPDM negru	FPM verde	Fibre compozite	Fibre compozite
	✓ ⁸⁾	✓ ⁸⁾	✓ ³⁾		✓ ³⁾		✓	✓
	✓ ⁸⁾	✓ ⁸⁾	✓ ³⁾				✓	✓
	✓ ⁸⁾	✓ ⁸⁾	✓ ³⁾			✓ ³⁾	✓	✓
	✓ ⁸⁾	✓ ⁸⁾		✓ ³⁾			✓	✓
	✓		✓		✓		✓	✓
	✓		✓		✓		✓	✓
	✓	✓		✓		✓	✓	✓
	9)			9)		9)	9)	9)
	9)			9)		9)	9)	9)
	✓		✓		✓		✓	✓
	✓			✓		✓	✓	✓



Geberit Mapress Oțel-Carbon

Țevi 1.0034

Țeavă Geberit Mapress Oțel-Carbon cu galvanizare exterioară

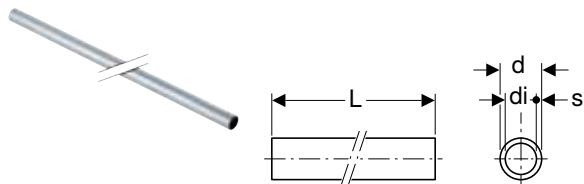

click & scan

Cod art.	DN	d, ø [mm]	di, ø [mm]	s [mm]	L [cm]	EUR/m
L / lungime: 6 m						
29101	10	12	9,6	1,2	600	2,68
29102	12	15	12,6	1,2	600	2,68
29103	15	18	15,6	1,2	600	3,13
29104	20	22	19	1,5	600	4,30
29105	25	28	25	1,5	600	5,59
29106	32	35	32	1,5	600	7,83
29107	40	42	39	1,5	600	10,14
29108	50	54	51	1,5	600	13,16
29159	65	76,1	72,1	2	600	34,29
29160	80	88,9	84,9	2	600	40,05
29161	100	108	104	2	600	46,63

Accesorii

- Aparat de tăiat țevi Geberit Mapress R → p. 324
- Aparat de debavurat țevi Geberit Mapress → p. 324
- Șablon de adâncime Geberit Mapress, cu știft de marcare → p. 325
- Debavurator electric de țevi Geberit RE 1 Mapress, în trusă → p. 324

Geberit Mapress Oțel-Carbon țeavă cu acoperire din plastic

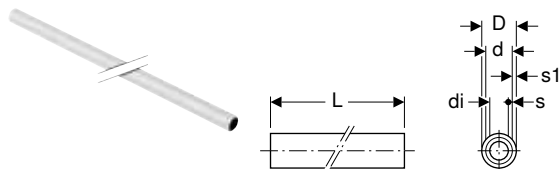

click & scan

Cod art.	DN	d, ø [mm]	di, ø [mm]	D [cm]	s1 [mm]	s [mm]	L [cm]	L [m]	EUR/m
19202	12	15	12,6	1,7	0,9	1,2	600	6	4,25
19203	15	18	15,6	2	0,9	1,2	600	6	4,95
19204	20	22	19	2,4	0,9	1,5	600	6	6,80
19205	25	28	25	3	0,9	1,5	600	6	8,82
19206	32	35	32	3,7	0,9	1,5	600	6	11,47
19207	40	42	39	4,4	0,9	1,5	600	6	14,88
19208	50	54	51	5,6	0,9	1,5	600	6	19,10

Accesorii

- Aparat de tăiat țevi Geberit Mapress R → p. 324
- Ascuțitoare de țeavă Geberit Mapress → p. 325
- Ascuțitoare de țeavă Geberit Mapress → p. 325
- Aparat de debavurat țevi Geberit Mapress → p. 324
- Șablon de adâncime Geberit Mapress, cu știft de marcare → p. 325

Țevi 1.0215

Țeavă Geberit Mapress Oțel-Carbon cu zincare interioară și exterioară

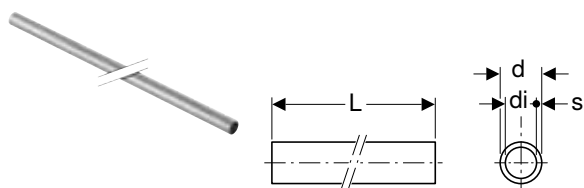

click & scan

Cod art.	DN	d, ø [mm]	di, ø [mm]	s [mm]	L [cm]	L [m]	EUR/m
19402	12	15	12	1,5	600	6	2,51
19403	15	18	15	1,5	600	6	2,90
19404	20	22	19	1,5	600	6	3,99
19405	25	28	25	1,5	600	6	5,15
19406	32	35	32	1,5	600	6	7,30
19407	40	42	39	1,5	600	6	9,45
19408	50	54	51	1,5	600	6	12,17
19409	65	76,1	72,1	2	600	6	31,88
19410	80	88,9	84,9	2	600	6	37,21
19411	100	108	104	2	600	6	43,30

Accesorii

- Aparat de tăiat țevi Geberit Mapress R → p. 324
- Aparat de debavurat țevi Geberit Mapress → p. 324
- Șablon de adâncime Geberit Mapress, cu știft de marcare → p. 325
- Debavurator electric de țevi Geberit RE 1 Mapress, în trusă → p. 324

Mufe

Mufă Geberit Mapress Oțel-Carbon



click & scan

EUR/buc.

Cod art.	DN	d, ø [mm]	L [cm]	Z [cm]	EUR/buc.
22001	10	12	4,2	0,8	2,55
22002	12	15	4,8	0,8	2,25
22003	15	18	4,8	0,8	2,42
22004	20	22	5	0,8	2,88
22005	25	28	5,4	0,8	3,45
22006	32	35	6,2	1	5,91
22007	40	42	7,1	1,1	8,11
22008	50	54	8,3	1,3	9,61
22009	65	76,1	12,7	2,1	53,37
22010	80	88,9	14,5	2,5	62,33
22011	100	108	17,6	2,6	80,11

Mufă Geberit Mapress Oțel-Carbon, redusă



click & scan

EUR/buc.

Cod art.	DN	d, ø [mm]	d1, ø [mm]	L [cm]	Z [cm]	EUR/buc.
22023	40 / 32	42	35	7,9	1,9	22,10
22024	50 / 32	54	35	9,3	2,8	30,46
22025	50 / 40	54	42	9,2	2,3	30,46

Mufă de inserție Geberit Mapress Oțel-Carbon

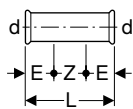

click & scan
EUR/buc.

Cod art.	DN	d, \varnothing [mm]	E [cm]	L [cm]	Z [cm]	
22102	12	15	2,5	8	3	2,85
22103	15	18	2,5	8	3	2,98
22104	20	22	2,5	8,4	3,4	3,31
22105	25	28	3	9,1	3,1	4,45
22106	32	35	3	10,2	4,2	8,60
22107	40	42	4	12	4	10,04
22108	50	54	4	14	6	12,95
22109	65	76,1	6	23	11	80,97
22110	80	88,9	7	26	12	91,62
22111	100	108	8	31	15	110,37

Reducții

Reducție Geberit Mapress Oțel-Carbon, cu capăt drept

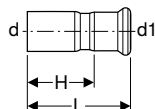

click & scan
EUR/buc.

Cod art.	DN	d, \varnothing [mm]	d1, \varnothing [mm]	L [cm]	H [cm]	
22303	15 / 12	18	15	5,5	3,5	3,00
22305	20 / 12	22	15	5,9	3,9	3,60
22306	20 / 15	22	18	5,7	3,7	3,60
22307	25 / 12	28	15	6,6	4,6	5,34
22308	25 / 15	28	18	6,4	4,4	5,34
22309	25 / 20	28	22	6	3,9	5,34
22310	32 / 12	35	15	7,5	5,5	10,04
22311	32 / 15	35	18	7,4	5,5	10,04
22312	32 / 20	35	22	7,1	5	10,04
22313	32 / 25	35	28	6,8	4,5	10,04
22315	40 / 15	42	18	8	6	11,12
22316	40 / 20	42	22	8,2	6,1	11,12
22317	40 / 25	42	28	8,3	6	11,12
22318	40 / 32	42	35	7,7	5,1	11,12
22320	50 / 15	54	18	9,5	7,5	15,94
22321	50 / 20	54	22	9,5	7,4	17,77
22322	50 / 25	54	28	11	8,7	17,77
22323	50 / 32	54	35	10,6	8	17,77
22324	50 / 40	54	42	9,2	6,2	17,77
22330	65 / 40	76,1	42	12,7	9,7	47,34
22331	65 / 50	76,1	54	14,6	11,1	47,40
22332	65 / 65	76,1	66,7	15,1	10,1	47,40
22338	80 / 50	88,9	54	16,2	12,8	57,63
22339	80 / 65	88,9	76,1	16,1	10,8	57,63
22345	100 / 50	108	54	17,2	13,7	62,12
22346	100 / 65	108	76,1	18,4	13,1	62,12
22348	100 / 80	108	88,9	20,3	14,3	62,12

Coturi

Cot Geberit Mapress Oțel-Carbon

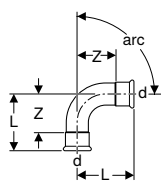

Cod art.	DN	d, ø [mm]	L [cm]	Z [cm]	EUR/buc.
arc / cot: 45°					
20601	10	12	3,2	1,5	3,49
20602	12	15	3,6	1,6	3,81
20603	15	18	3,7	1,7	4,08
20604	20	22	4,2	2,1	4,53
20605	25	28	4,8	2,5	6,03
23606	32	35	4,3	1,7	11,30
23607	40	42	5,1	2,1	17,89
23608	50	54	6,2	2,7	23,77
20609	65	76,1	10,3	5	80,11
20610	80	88,9	11,7	5,7	96,13
20611	100	108	14,3	6,8	131,72
arc / cot: 90°					
20101	10	12	4,2	2,5	3,51
20102	12	15	4,9	2,9	3,79
20103	15	18	5,3	3,3	4,08
20104	20	22	6,1	4	4,53
20105	25	28	7,2	4,9	6,03
23106	32	35	6,8	4,2	11,30
23107	40	42	8	5	17,89
23108	50	54	10	6,5	23,77
20109	65	76,1	15,9	10,6	80,11
20110	80	88,9	18,5	12,5	96,13
20111	100	108	23	15,5	131,72



Cot Geberit Mapress Oțel-Carbon, cu capăt drept

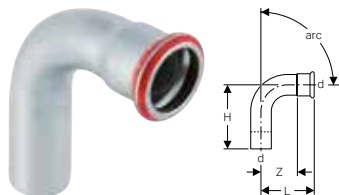

click & scan

Cod art.	DN	d, ø [mm]	L [cm]	H [cm]	Z [cm]	EUR/buc.
arc / cot: 45°						
20701	10	12	3,2	4,1	1,5	3,67
20702	12	15	3,6	4,5	1,6	3,81
20703	15	18	3,7	4,2	1,7	4,08
20704	20	22	4,2	5,2	2,1	4,53
20705	25	28	4,8	5,6	2,5	6,03
23706	32	35	4,3	5,3	1,7	11,30
23707	40	42	5,1	6,1	2,1	17,89
23708	50	54	6,2	7,3	2,7	24,25
20709	65	76,1	10,3	11,1	5	80,11
20710	80	88,9	11,7	12,8	5,7	96,13
20711	100	108	14,3	15,8	6,8	131,72
arc / cot: 90°						
20301	10	12	4,2	5,2	2,5	3,67
20302	12	15	4,9	5,9	2,9	3,81
20303	15	18	5,3	6,1	3,3	4,08
20304	20	22	6,1	7	4	4,53
20305	25	28	7,2	7,9	4,9	6,03
23306	32	35	6,8	7,4	4,2	11,30
23307	40	42	8	8,8	5	17,89
23308	50	54	10	10,8	6,5	23,77
20309	65	76,1	15,9	16,7	10,6	80,11
20310	80	88,9	18,5	19,5	12,5	96,13
20311	100	108	23	24,1	15,5	131,72

Cot de adaptare Geberit Mapress Oțel-Carbon 90°

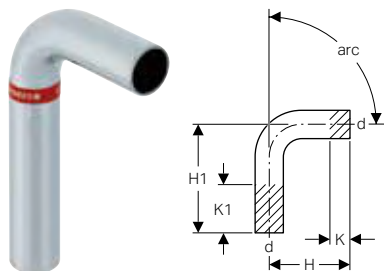

click & scan

Cod art.	DN	d, ø [mm]	arc [°]	H [cm]	H1 [cm]	K [cm]	K1 max. [cm]	EUR/buc.
20402	12	15	90	5,9	12,9	0	7	4,29
20403	15	18	90	6,1	13,3	0	7,2	4,68
20404	20	22	90	7	14,2	0	7,2	5,05
20405	25	28	90	7,9	15,5	0	7,6	6,78
20406	32	35	90	7,7	15,4	0	7,7	12,67
20407	40	42	90	9	18	0	9	20,06
20408	50	54	90	11,1	20,5	0	9,4	26,65

Cot în S Geberit Mapress Oțel-Carbon

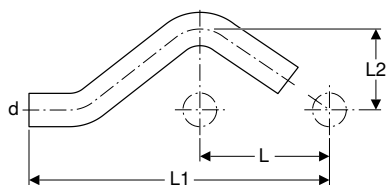

click & scan

Cod art.	DN	d, ø [mm]	L [cm]	L1 [cm]	L2 [cm]	EUR/buc.
20801	10	12	6	16,4	3,2	3,52
20802	12	15	6	16,5	3,2	3,67
20803	15	18	6	16,6	3,3	4,08
20804	20	22	6	16,8	3,5	4,83
20805	25	28	6	17,9	3,8	5,36

Teuri

Teu Geberit Mapress Oțel-Carbon, egal

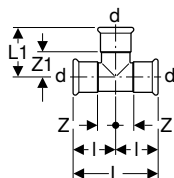

click & scan

Cod art.	DN	d, ø [mm]	arc [°]	L [cm]	L1 [cm]	I [cm]	Z [cm]	Z1 [cm]	EUR/buc.
21001	10	12	90	5,6	3,5	2,8	1,1	1,8	5,46
21002	12	15	90	6,4	3,9	3,2	1,2	1,9	6,20
21003	15	18	90	6,8	4,1	3,4	1,4	2,1	6,56
21004	20	22	90	7,4	4,4	3,7	1,6	2,3	6,84
21005	25	28	90	8,4	5	4,2	1,9	2,7	9,61
21006	32	35	90	10	5,7	5	2,4	3,1	14,49
21007	40	42	90	11,4	6,5	5,7	2,7	3,5	20,24
21008	50	54	90	13,8	7,7	6,9	3,4	4,2	24,79
21009	65	76,1	90	23	11	11,5	6,2	5,7	155,95
21010	80	88,9	90	26	12,7	13	7	6,7	177,79
21011	100	108	90	31	15,3	15,5	8	7,8	202,41



Teu Geberit Mapress Oțel-Carbon, redus

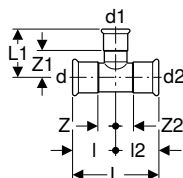

Cod art.	DN	d, ø [mm]	d1, ø [mm]	d2, ø [mm]	arc [°]	L [cm]	L1 [cm]	I [cm]	I2 [cm]	Z [cm]	Z1 [cm]	Z2 [cm]	EUR/buc.
21103	12 / 15 / 12	15	18	15	90	6,4	3,6	3,2	3,2	1,2	1,6	1,2	6,56
21104	12 / 20 / 12	15	22	15	90	6,4	4,2	3,2	3,2	1,2	2,1	1,2	6,84
21204	15 / 12 / 15	18	15	18	90	6,8	4,2	3,4	3,4	1,4	2,2	1,4	6,56
21105	15 / 20 / 15	18	22	18	90	6,8	4,1	3,4	3,4	1,4	2	1,4	6,84
21206	20 / 12 / 20	22	15	22	90	7,4	4,4	3,7	3,7	1,6	2,4	1,6	6,84
21207	20 / 15 / 20	22	18	22	90	7,4	4,4	3,7	3,7	1,6	2,4	1,6	6,84
21107	20 / 25 / 20	22	28	22	90	7,4	4,5	3,7	3,7	1,6	2,2	1,6	9,61
21209	25 / 12 / 25	28	15	28	90	8,4	4,7	4,2	4,2	1,9	2,7	1,9	9,61
21210	25 / 15 / 25	28	18	28	90	8,4	4,7	4,2	4,2	1,9	2,7	1,9	9,61
21211	25 / 20 / 25	28	22	28	90	8,4	4,8	4,2	4,2	1,9	2,7	1,9	9,61
21212	32 / 12 / 32	35	15	35	90	10	5,1	5	5	2,4	3,1	2,4	14,78
21213	32 / 15 / 32	35	18	35	90	10	5,1	5	5	2,4	3,1	2,4	14,78
21214	32 / 20 / 32	35	22	35	90	10	5,2	5	5	2,4	3,1	2,4	14,78
21215	32 / 25 / 32	35	28	35	90	10	5,5	5	5	2,4	3,2	2,4	14,78
21216	40 / 12 / 40	42	15	42	90	11,4	5,3	5,7	5,7	2,7	3,3	2,7	19,85
21217	40 / 15 / 40	42	18	42	90	11,4	5,3	5,7	5,7	2,7	3,3	2,7	19,85
21218	40 / 20 / 40	42	22	42	90	11,4	5,5	5,7	5,7	2,7	3,4	2,7	20,24
21219	40 / 25 / 40	42	28	42	90	11,4	5,8	5,7	5,7	2,7	3,5	2,7	20,24
21220	40 / 32 / 40	42	35	42	90	11,4	6,1	5,7	5,7	2,7	3,5	2,7	20,24
21221	50 / 12 / 50	54	15	54	90	13,8	5,9	6,9	6,9	3,4	3,9	3,4	24,31
21222	50 / 15 / 50	54	18	54	90	13,8	5,9	6,9	6,9	3,4	3,9	3,4	24,31
21223	50 / 20 / 50	54	22	54	90	13,8	6,1	6,9	6,9	3,4	4	3,4	24,79
21224	50 / 25 / 50	54	28	54	90	13,8	6,4	6,9	6,9	3,4	4,1	3,4	24,79
21225	50 / 32 / 50	54	35	54	90	13,8	6,8	6,9	6,9	3,4	4,2	3,4	24,79
21226	50 / 40 / 50	54	42	54	90	13,8	7,2	6,9	6,9	3,4	4,2	3,4	24,79
21230	65 / 25 / 65	76,1	28	76,1	90	23	7,5	11,5	11,5	6,2	5,2	6,2	152,60
21231	65 / 32 / 65	76,1	35	76,1	90	23	7,9	11,5	11,5	6,2	5,3	6,2	152,60
21232	65 / 40 / 65	76,1	42	76,1	90	23	8,3	11,5	11,5	6,2	5,3	6,2	152,60
21233	65 / 50 / 65	76,1	54	76,1	90	23	8,9	11,5	11,5	6,2	5,4	6,2	152,60
21234	65 / 65 / 65	76,1	66,7	76,1	90	23	11	11,5	11,5	6,2	6	6,2	152,60
21237	80 / 25 / 80	88,9	28	88,9	90	26	8,1	13	13	7	5,8	7	171,29
21238	80 / 32 / 80	88,9	35	88,9	90	26	8,5	13	13	7	5,9	7	171,29
21239	80 / 40 / 80	88,9	42	88,9	90	26	8,9	13	13	7	5,9	7	171,29
21240	80 / 50 / 80	88,9	54	88,9	90	26	9,5	13	13	7	6	7	171,29
21241	80 / 65 / 80	88,9	76,1	88,9	90	26	11,6	13	13	7	6,3	7	171,29
21245	100 / 25 / 100	108	28	108	90	31	9,1	15,5	15,5	8	6,8	8	206,46
21246	100 / 32 / 100	108	35	108	90	31	9,5	15,5	15,5	8	6,9	8	206,46
21247	100 / 40 / 100	108	42	108	90	31	9,9	15,5	15,5	8	6,9	8	206,46
21248	100 / 50 / 100	108	54	108	90	31	10,5	15,5	15,5	8	7	8	206,46
21249	100 / 65 / 100	108	76,1	108	90	31	12,6	15,5	15,5	8	7,3	8	206,46
21250	100 / 80 / 100	108	88,9	108	90	31	13,7	15,5	15,5	8	7,7	8	206,46

Teu Geberit Mapress Oțel-Carbon, cu filet interior

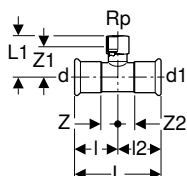

click & scan

Cod art.	DN	d, ø [mm]	Rp ["]	d1, ø [mm]	arc [°]	L [cm]	L1 [cm]	I [cm]	I2 [cm]	Z [cm]	Z1 [cm]	Z2 [cm]	EUR/buc.
21304	12 / 15 / 12	15	1/2"	15	90	6,4	3,7	3,2	3,2	1,2	2,4	1,2	8,92
21305	15	18	1/2"	18	90	6,8	3,9	3,4	3,4	1,4	2,6	1,4	8,92
21307	20 / 15 / 20	22	1/2"	22	90	7,4	4	3,7	3,7	1,6	2,7	1,6	9,74
21308	20 / 20 / 20	22	3/4"	22	90	7,4	4,4	3,7	3,7	1,6	2,8	1,6	9,74
21309	25 / 15 / 25	28	1/2"	28	90	8,4	4,4	4,2	4,2	1,9	3,1	1,9	11,30
21310	25 / 20 / 25	28	3/4"	28	90	8,4	4,7	4,2	4,2	1,9	3,2	1,9	11,30
21311	25	28	1"	28	90	8,4	5,3	4,2	4,2	1,9	3,6	1,9	10,98
21312	32 / 15 / 32	35	1/2"	35	90	10	4,8	5	5	2,4	3,5	2,4	15,63
21313	32 / 20 / 32	35	3/4"	35	90	10	5,1	5	5	2,4	3,6	2,4	15,63
21314	32 / 25 / 32	35	1"	35	90	10	5,6	5	5	2,4	3,9	2,4	15,78
21316	40 / 15 / 40	42	1/2"	42	90	11,4	5,1	5,7	5,7	2,7	3,8	2,7	24,48
21317	40 / 20 / 40	42	3/4"	42	90	11,4	5,4	5,7	5,7	2,7	3,9	2,7	24,48
21318	40 / 25 / 40	42	1"	42	90	11,4	6	5,7	5,7	2,7	4,3	2,7	24,08
21320	50 / 15 / 50	54	1/2"	54	90	13,8	5,7	6,9	6,9	3,4	4,4	3,4	26,47
21321	50 / 20 / 50	54	3/4"	54	90	13,8	6	6,9	6,9	3,4	4,5	3,4	26,47
21322	50 / 25 / 50	54	1"	54	90	13,8	6,6	6,9	6,9	3,4	4,9	3,4	26,47
21324	50	54	2"	54	90	13,8	7,9	6,9	6,9	3,4	5,6	3,4	26,47
21326	65 / 20 / 65	76,1	3/4"	76,1	90	23	7,4	11,5	11,5	6,2	5,9	6,2	92,25
21329	65 / 50 / 65	76,1	2"	76,1	90	23	9,1	11,5	11,5	6,2	6,8	6,2	92,25
21331	80 / 20 / 80	88,9	3/4"	88,9	90	26	8	13	13	7	6,5	7	108,27
21334	80 / 50 / 80	88,9	2"	88,9	90	26	9,7	13	13	7	7,4	7	108,27
21336	100 / 20 / 100	108	3/4"	108	90	31	9	15,5	15,5	8	7,5	8	113,96

Teu Geberit Mapress Oțel-Carbon, cu filet interior și capete drepte

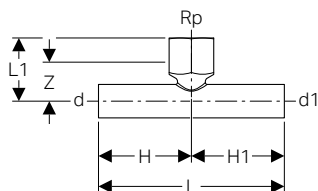

click & scan

Cod art.	DN	d, ø [mm]	Rp ["]	d1, ø [mm]	arc [°]	L [cm]	L1 [cm]	H [cm]	H1 [cm]	Z [cm]	EUR/buc.
21341	15	18	1/2"	18	90	10	3,4	5	5	2,1	8,48
21342	20 / 15 / 20	22	1/2"	22	90	10	3,6	5	5	2,3	9,22
21343	25 / 15 / 25	28	1/2"	28	90	10	4,3	5	5	3	10,78
21344	32 / 15 / 32	35	1/2"	35	90	11,4	4,7	5,7	5,7	3,4	14,83
21345	40 / 15 / 40	42	1/2"	42	90	13,4	5	6,7	6,7	3,7	23,23
21346	50 / 15 / 50	54	1/2"	54	90	14,6	5,7	7,3	7,3	4,4	25,13



Elemente în cruce

Element în cruce Geberit Mapress Oțel-Carbon, redus

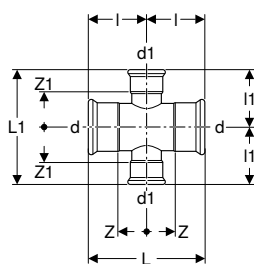

click & scan

Cod art.	DN	d, ø [mm]	d1, ø [mm]	arc [°]	L [cm]	L1 [cm]	l [cm]	l1 [cm]	Z [cm]	Z1 [cm]	EUR/buc.
21121	40 / 25	42	28	90	11,4	11,6	5,7	5,8	2,7	3,5	35,02
21122	50 / 25	54	28	90	13,8	12,8	6,9	6,4	3,4	4,1	39,23
21123	50 / 32	54	35	90	13,8	13,6	6,9	6,8	3,4	4,2	39,23
21127	65 / 25	76,1	28	90	23	15,8	11,5	7,9	6,2	5,6	211,48
21128	65 / 32	76,1	35	90	23	16,2	11,5	8,1	6,2	5,5	211,48
21130	80 / 25	88,9	28	90	26	17,4	13	8,7	7	6,4	245,29
21131	80 / 32	88,9	35	90	26	18	13	9	7	6,4	245,29
21133	100 / 25	108	28	90	31	20	15,5	10	8	7,7	281,29
21134	100 / 32	108	35	90	31	20	15,5	10	8	7,4	281,29

Element în cruce Geberit Mapress Oțel-Carbon 30°, redus

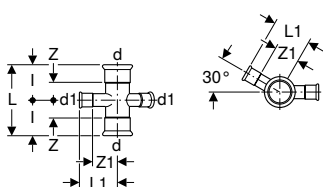

click & scan

Cod art.	DN	d, ø [mm]	d1, ø [mm]	arc [°]	L [cm]	L1 [cm]	l [cm]	Z [cm]	Z1 [cm]	EUR/buc.
21404	15 / 12	18	15	30	6,8	4	3,4	1,4	2	17,31
21406	20 / 12	22	15	30	7,4	4,2	3,7	1,6	2,2	17,89
21409	25 / 12	28	15	30	8,4	4,5	4,2	1,9	2,5	20,24

Element în cruce Geberit Mapress Oțel-Carbon, redus, montat

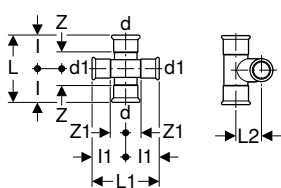

click & scan

Cod art.	DN	d, ø [mm]	d1, ø [mm]	arc [°]	L [cm]	L1 [cm]	L2 [cm]	l [cm]	l1 [cm]	Z [cm]	Z1 [cm]	EUR/buc.
21504	12	15	15	90	6,4	6,4	2	3,2	3,2	1,2	1,2	17,31
21505	15 / 12	18	15	90	6,8	8,4	2,3	3,4	4,2	1,4	2,2	17,31
21506	20 / 12	22	15	90	7,4	8,4	2,5	3,7	4,2	1,6	2,2	17,89
21509	20 / 15	22	18	90	7,4	8,4	2,6	3,7	4,2	1,6	2,2	17,89
21507	25 / 12	28	15	90	8,4	8,4	2,9	4,2	4,2	1,9	2,2	20,24
21510	25 / 15	28	18	90	8,4	8,4	3,2	4,2	4,2	1,9	2,2	20,24
21512	25 / 20	28	22	90	8,4	8,4	3,3	4,2	4,2	1,9	2,1	20,24

Adaptoare, fără posibilitate de desfacere

Nou

Adaptor Geberit FlowFit la Geberit Mapress, cu capăt drept

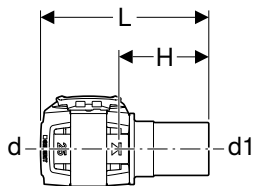

click & scan

Cod art.	DN	d, ø [mm]	d1, ø [mm]	L [cm]	H [cm]	EUR/buc.
620.230.00.1	12 / 10	16	12	6,8	3,5	7,72
620.240.00.1	12	16	15	6,9	3,6	7,72
620.231.00.1	15 / 12	20	15	6,9	3,6	9,96
620.241.00.1	15	20	18	6,9	3,6	9,96
620.242.00.1	15 / 20	20	22	7	3,7	9,96
620.232.00.1	20	25	22	7	3,7	13,82
620.233.00.1	25	32	28	7,7	4,1	18,82
620.234.00.1	32	40	35	8	4,4	22,11
620.235.00.1	40	50	42	12,8	6,9	49,75
620.236.00.1	50	63	54	13,8	7,5	77,37

Livrabil din April 2024

Adaptor Geberit Mapress Oțel-Carbon, cu capăt de sudare și capăt drept

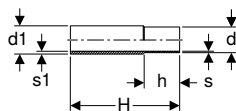

click & scan

Cod art.	DN	d, ø [mm]	d1, ø [mm]	s1 [mm]	s [mm]	H [cm]	h [cm]	EUR/buc.
12412	12	15	17,2	2,3	1,2	12	3	5,23
12413	15	18	21,3	2,9	1,2	12	3	5,36
12414	20	22	26,9	4	1,5	12	3,4	5,80
12415	25	28	33,7	4,4	1,5	12	3,4	7,50
12416	32	35	42,4	5,2	1,5	12	4	8,89
12417	40	42	48,3	4,7	1,5	12	4,5	10,57
12418	50	54	60,3	4,7	1,5	12	5	13,01
12419	65	76,1	76,1	3,7	2	12	7	22,84
12420	80	88,9	88,9	4,1	2	12	7,5	27,89
12421	100	108	114,3	5,2	2	12	9	38,58



Adaptor Geberit Mapress Oțel-Carbon, cu filet exterior

 click & scan
 EUR/buc.

Cod art.	DN	d, ø [mm]	R ["]	L [cm]	H [cm]	
21701	10	12	3/8"	3,3	1,6	6,39
21700	10 / 15	12	1/2"	3,6	2,2	6,39
21702	12 / 10	15	3/8"	3,8	1,8	6,40
21703	12 / 15	15	1/2"	4,1	2,1	6,40
21714	12 / 20	15	3/4"	4,3	2,6	6,30
21704	15	18	1/2"	4,2	2,2	7,02
21705	15 / 20	18	3/4"	4,4	2,4	7,02
21715	20 / 15	22	1/2"	4	2,2	7,36
21707	20	22	3/4"	4,4	2,3	7,50
21716	20 / 25	22	1"	4,6	2,6	7,28
21717	25 / 20	28	3/4"	4,6	2,6	9,77
21708	25	28	1"	4,8	2,5	10,04
21727	25 / 32	28	1 1/4"	4,8	2,8	9,77
21719	32 / 25	35	1"	5,1	2,5	13,29
21709	32	35	1 1/4"	5,3	2,7	13,27
21720	32 / 40	35	1 1/2"	5,3	3	13,01
21721	40 / 32	42	1 1/4"	5,7	2,7	15,63
21710	40	42	1 1/2"	5,7	2,7	15,63
21722	50 / 40	54	1 1/2"	7,1	3,6	23,05
21711	50	54	2"	7,1	3,6	23,05
21713	65	76,1	2 1/2"	11,9	4,3	39,97
21724	80	88,9	3"	13,7	5	62,24
21725	100	108	4"	16	6,1	83,01

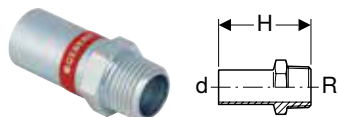
Adaptor Geberit Mapress Oțel-Carbon, cu filet exterior și capăt drept

 click & scan
 EUR/buc.

Cod art.	DN	d, ø [mm]	R ["]	H [cm]	
21932	12 / 15	15	1/2"	5,7	6,40
21933	15	18	1/2"	5,7	7,02
21934	15 / 20	18	3/4"	5,9	7,02
21935	20 / 15	22	1/2"	5,7	7,50
21936	20	22	3/4"	5,9	7,50
21937	25	28	1"	6,6	9,77
21938	32	35	1 1/4"	8	13,01
21939	40	42	1 1/2"	9,1	15,29
21940	50	54	2"	10,2	22,62

Adaptor Geberit Mapress Oțel-Carbon, cu filet interior

 click & scan
 EUR/buc.

Cod art.	DN	d, ø [mm]	Rp ["]	L [cm]	Z [cm]	
21800	10	12	3/8"	3,1	0,3	6,39
21801	10 / 15	12	1/2"	3,4	0,4	6,39
21827	12 / 10	15	3/8"	3,3	0,3	6,40
21802	12 / 15	15	1/2"	3,7	0,4	6,40
21823	12 / 20	15	3/4"	3,8	0,7	6,30
21803	15	18	1/2"	3,7	0,4	7,02
21804	15 / 20	18	3/4"	3,8	0,3	7,02
21805	20 / 15	22	1/2"	3,8	0,3	7,36

Cod art.	DN	d, ø [mm]	Rp ["]	L [cm]	Z [cm]	EUR/buc.
21806	20	22	3/4"	3,9	0,3	7,50
21824	20 / 25	22	1"	4,2	0,4	7,36
21807	25 / 15	28	1/2"	3,8	0,2	10,04
21808	25 / 20	28	3/4"	3,8	0,1	9,77
21809	25	28	1"	4,4	0,4	10,04
21810	32 / 20	35	3/4"	4,2	0,1	13,01
21820	32 / 25	35	1"	4,5	0,2	13,01
21811	32	35	1 1/4"	4,9	0,4	13,01
21814	40	42	1 1/2"	5,3	0,4	15,29
21818	50	54	2"	6,2	0,5	22,62

Adaptor Geberit Mapress Oțel-Carbon, cu filet interior și capăt drept

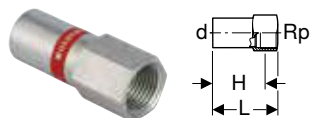

click & scan

EUR/buc.

Cod art.	DN	d, ø [mm]	Rp ["]	L [cm]	H [cm]	EUR/buc.
21908	12 / 10	15	3/8"	7,4	6	6,30
21902	12 / 15	15	1/2"	6,1	4,8	6,40
21903	15	18	1/2"	6,1	4,8	7,02
21904	15 / 20	18	3/4"	6,4	4,9	7,02
21905	20 / 15	22	1/2"	6,2	4,9	7,50
21906	20	22	3/4"	6,5	5	7,50
21910	25 / 15	28	1/2"	7,1	5,6	9,22
21912	32 / 15	35	1/2"	7,7	5,2	13,46
21914	40 / 15	42	1/2"	8,1	5,7	15,71
21916	50 / 15	54	1/2"	8,6	6,2	20,11
21918	65 / 15	76,1	1/2"	10,5	8,7	51,98
21920	80 / 15	88,9	1/2"	11,5	10,2	69,30
21922	100 / 15	108	1/2"	12,7	11,4	101,71

Cot adaptor Geberit Mapress Oțel-Carbon 90° cu filet exterior

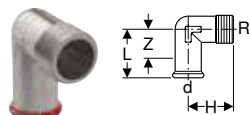

click & scan

EUR/buc.

Cod art.	DN	d, ø [mm]	R ["]	arc [°]	L [cm]	H [cm]	Z [cm]	EUR/buc.
21611	10	12	3/8"	90	3,2	2,5	1,5	7,14
21612	12 / 10	15	3/8"	90	3,6	2,6	1,6	7,85
21613	12 / 15	15	1/2"	90	3,5	3,1	1,5	7,85
21615	15	18	1/2"	90	3,7	3,1	1,7	8,46
21618	20	22	3/4"	90	4,1	3,5	2	11,32
21609	25 / 20	28	3/4"	90	5,8	5	3,5	15,63
21610	25	28	1"	90	5,8	5,4	3,5	15,63

Cot adaptor Geberit Mapress Oțel-Carbon 90° cu filet interior

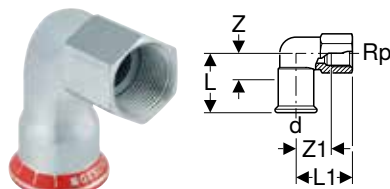

click & scan

Cod art.	DN	d, ø [mm]	Rp ["]	arc [°]	L [cm]	L1 [cm]	Z [cm]	Z1 [cm]	EUR/buc.
21659	20 / 15	22	1/2"	90	4,2	4	2,1	2,7	11,32
21660	25 / 15	28	1/2"	90	4,7	4,4	2,4	3,1	15,63
21661	25 / 20	28	3/4"	90	5,8	5	3,5	3,5	15,63
21662	25	28	1"	90	5,8	5,4	3,5	3,6	15,63

Accesorii

- Dispozitiv de fixare pentru cot adaptor Geberit Mapress 90° → p. 200

Cot adaptor Geberit Mapress Oțel-Carbon 90° cu filet exterior

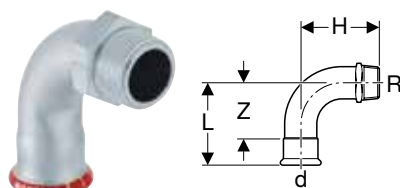

click & scan

Cod art.	DN	d, ø [mm]	R ["]	arc [°]	L [cm]	H [cm]	Z [cm]	EUR/buc.
20502	12 / 10	15	3/8"	90	4,9	3,7	2,9	7,85
20503	12 / 15	15	1/2"	90	4,9	4	2,9	7,85
20505	15	18	1/2"	90	5,3	4,7	3,3	8,46
20507	20	22	3/4"	90	6,1	5,4	4	11,32
20508	25	28	1"	90	7,2	6,6	4,9	15,94
23509	32	35	1 1/4"	90	6,8	9,8	4,2	21,54
23510	40	42	1 1/2"	90	8	11,3	5	37,85
23511	50	54	2"	90	10	13,8	6,5	48,20

Cot adaptor Geberit Mapress Oțel-Carbon 90° cu filet interior

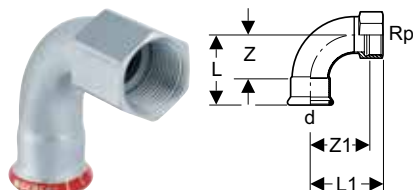

click & scan

Cod art.	DN	d, ø [mm]	Rp ["]	arc [°]	L [cm]	L1 [cm]	Z [cm]	Z1 [cm]	EUR/buc.
20551	10	12	3/8"	90	4,2	4,1	2,5	3	7,12
20552	12 / 10	15	3/8"	90	4,9	4,5	2,9	3,4	7,85
20553	12 / 15	15	1/2"	90	4,9	4,8	2,9	3,3	7,85
20555	15	18	1/2"	90	5,3	5,2	3,3	3,7	8,46
20557	20	22	3/4"	90	6,1	6	4	4,4	11,32
20558	25 / 15	28	1/2"	90	7,2	6,5	4,9	5	15,94
20559	25	28	1"	90	7,2	6,6	4,9	4,7	15,63
20560	32	35	1 1/4"	90	6,8	7,5	4,2	5,4	21,10
20561	40	42	1 1/2"	90	8	8,4	5	6,3	37,07
20562	50	54	2"	90	10	10,4	6,5	7,8	47,31

Accesorii

- Dispozitiv de fixare pentru cot adaptor Geberit Mapress 90° → p. 200

Adaptoare și conexiuni, cu posibilitate de desfacere

Îmbinare filetată Geberit Mapress Oțel-Carbon

click & scan
EUR/buc.

Cod art.	DN	d, ø [mm]	G ["]	L [cm]	Z [cm]	EUR/buc.
25320	12	15	3/4"	6,6	2,6	17,65
25321	15	18	3/4"	6,9	2,9	20,11
25322	20	22	1"	7,2	3	24,94
25323	25	28	1 1/4"	7,7	3,1	41,47
25324	32	35	1 1/2"	8,2	3	56,98
25325	40	42	1 3/4"	9,5	3,5	82,07
25326	50	54	2 3/8"	11,3	4,3	136,19

Adaptor cu filet Geberit Mapress Oțel-Carbon, cu filet exterior

click & scan
EUR/buc.

Cod art.	DN	d, ø [mm]	R ["]	G ["]	L [cm]	H [cm]	EUR/buc.
25330	12 / 15	15	1/2"	3/4"	6,1	4,1	8,78
25332	15	18	1/2"	3/4"	6,1	4,1	10,08
25335	20	22	3/4"	1"	6,8	4,7	13,12
25329	20 / 25	22	1"	1"	6,9	4,8	12,83
25337	25	28	1"	1 1/4"	7,5	5,2	19,34
25338	32	35	1 1/4"	1 1/2"	8	5,4	27,77
25339	40	42	1 1/2"	1 3/4"	8,5	5,5	40,41
25340	50	54	2"	2 3/8"	9,7	6,2	90,16

Adaptor cu filet Geberit Mapress Oțel-Carbon, cu filet interior

click & scan
EUR/buc.

Cod art.	DN	d, ø [mm]	Rp ["]	G ["]	L [cm]	Z [cm]	EUR/buc.
25300	12 / 15	15	1/2"	3/4"	5,8	2,3	8,63
25302	15	18	1/2"	3/4"	5,8	2,3	9,87
25304	20	22	3/4"	1"	6,3	2,3	12,83
25305	20 / 25	22	1"	1"	6,6	3	12,83
25306	25	28	1"	1 1/4"	7,1	3,3	18,98
25307	32	35	1 1/4"	1 1/2"	7,7	3,5	27,24
25308	40	42	1 1/2"	1 3/4"	8,2	3,1	39,62
25309	50	54	2"	2 3/8"	9,5	3,4	88,43

Racord Geberit Mapress Oțel-Carbon, cu piuliță

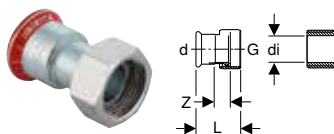

click & scan

Cod art.	DN	d, ø [mm]	G ["]	di, ø [mm]	L [cm]	Z [cm]	EUR/buc.
25042	12	15	1/2"	10	5,1	2,5	7,79
25048	15	18	1/2"	10	5,3	2,6	8,74
25049	20	22	3/4"	13	5,4	2,7	9,20

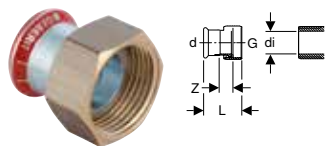
Adaptor Geberit Mapress Oțel-Carbon, cu piuliță

click & scan

Cod art.	DN	d, ø [mm]	G ["]	di, ø [mm]	L [cm]	Z [cm]	EUR/buc.
25032	12	15	3/4"	13	3,7	1,1	5,18
25033	15	18	3/4"	13	3,7	1,1	5,27
25040	15	18	1"	20	3,9	1,1	8,74
25034	20	22	1"	20	4	1,1	7,43
25044	20	22	1 1/4"	26	4,3	1,3	9,20
25035	25	28	1 1/4"	26	4,4	1,3	10,39
25050	25	28	1 1/2"	32	4,6	1,3	10,39
25036	32	35	1 1/2"	32	4,8	1,3	16,46
25051	32	35	2"	42	4,8	1,2	16,46
25037	40	42	1 3/4"	39	5,2	1,3	22,25
25052	40	42	2"	42	5,4	1,4	22,25
25053	40	42	2 1/4"	42	5,6	1,4	22,25
25038	50	54	2 3/8"	51	5,8	1,5	38,97
25054	50	54	2 1/2"	54	6,3	1,4	40,50
25055	50	54	2 3/4"	57	6,3	1,4	40,50
25045	65	76,1	3"	73	9,9	3,3	79,38
25046	80	88,9	3 1/2"	84	11,1	3,7	137,41

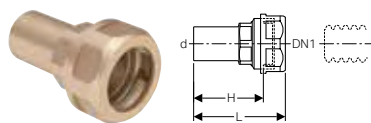
Adaptor Geberit Mapress cu îmbinare filetată inelară de fixare pentru tuburi ondulate, apă nepotabilă, capăt drept

click & scan

Cod art.	DN	DN1	d, ø [mm]	L [cm]	H [cm]	PN [bar]	EUR/buc.
22421	12	16	15	6,4	4,9	10	16,93
22431	12	20	15	6,7	5,2	10	19,77
22422	15	16	18	6,4	4,9	10	18,35
22432	15	20	18	6,7	5,2	10	21,23
22423	20	16	22	6,8	5,9	10	19,77
22433	20	20	22	6,8	5,9	10	22,60
22444	25	25	28	6,8	5,9	10	31,05

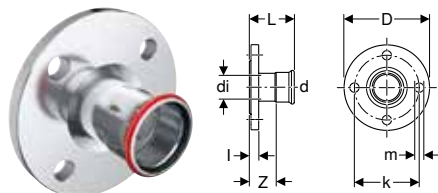

- În cazul unor presiuni de exploatare diferite pentru îmbinarea filetată și țeava ondulată trebuie luată în considerație presiunea de exploatare mai mică.

Flanșă Geberit Mapress Oțel-Carbon PN 6, cu mufă de sertizare

click & scan

Cod art.	DN	d, ø [mm]	di, ø [mm]	D [cm]	k [mm]	m [mm]	L [cm]	I [cm]	Z [cm]	n [pc.]	PN [bar]	EUR/buc.
23744	20	22	19	9	65	11	6,1	1,4	4	4	6	34,16
23745	25	28	25	10	75	11	6,5	1,4	4,2	4	6	42,75
23746	32	35	32	12	90	14	6,8	1,4	4,2	4	6	54,97
23747	40	42	39	13	100	14	7,5	1,4	4,5	4	6	68,40
23748	50	54	51	14	110	14	8,3	1,4	4,8	4	6	85,53
23749	65	76,1	72	16	130	14	11,4	1,4	6,1	4	6	109,96
23750	80	88,9	84,8	19	150	18	12,1	1,6	6,1	4	6	134,38
23751	100	108	103,9	21	170	18	12,6	1,6	5,1	4	6	158,79

Accesorii

- Set șurub Geberit pentru conexiune cu flanșă, din oțel galvanizat → p. 158
- Garnitură flanșă Geberit PN 6, din fibre compozite → p. 158

Flanșă Geberit Mapress Oțel-Carbon PN 10/16, cu mufă de sertizare

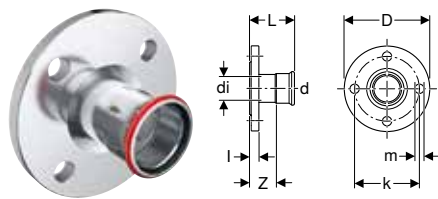

Cod art.	DN	d, ø [mm]	di, ø [mm]	D [cm]	k [mm]	m [mm]	L [cm]	I [cm]	Z [cm]	n [pc.]	PN [bar]	EUR/buc.
23754	20	22	19	10,5	75	14	6,5	1,8	4,4	4	10 / 16	34,24
23755	25	28	25	11,5	85	14	6,9	1,8	4,6	4	10 / 16	36,20
23756	32	35	32	14	100	18	7,2	1,8	4,6	4	10 / 16	53,74
23757	40	42	39	15	110	18	7,9	1,8	4,9	4	10 / 16	61,80
23758	50	54	51	16,5	125	18	8,7	1,8	5,2	4	10 / 16	63,96
23759	65	76,1	72	18,5	145	18	11,8	1,8	6,5	4	10 / 16	116,78
23760	80	88,9	84,8	20	160	18	12,5	2	6,5	8	10 / 16	139,42
23761	100	108	103,9	22	180	18	13	2	5,5	8	10 / 16	163,69

Accesorii

- Set șurub Geberit pentru conexiune cu flanșă, din oțel galvanizat → p. 158
- Garnitură flanșă Geberit PN 10/16, din fibre compozite → p. 157

Flanșă Geberit Mapress Oțel-Carbon PN 6, cu capăt drept

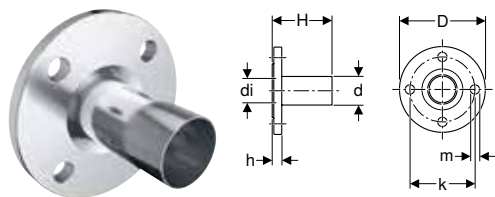

Cod art.	DN	d, ø [mm]	di, ø [mm]	D [cm]	k [mm]	m [mm]	H [cm]	h [cm]	n [pc.]	PN [bar]	EUR/buc.
23764	20	22	19	9	65	11	7,5	1,4	4	6	34,16
23765	25	28	25	10	75	11	7,7	1,4	4	6	49,86
23766	32	35	32	12	90	14	8,6	1,4	4	6	54,97
23767	40	42	39	13	100	14	10,4	1,4	4	6	68,40
23768	50	54	51	14	110	14	10,9	1,4	4	6	85,53
23769	65	76,1	72	16	130	14	13,2	1,4	4	6	109,96
23770	80	88,9	84,8	19	150	18	14,8	1,6	4	6	134,38
23771	100	108	103,9	21	170	18	16,1	1,6	4	6	158,79

Accesorii

- Set șurub Geberit pentru conexiune cu flanșă, din oțel galvanizat → p. 158
- Garnitură flanșă Geberit PN 6, din fibre compozite → p. 158



Flanșă oțel carbon PN 10/16 Geberit Mapress cu inserții

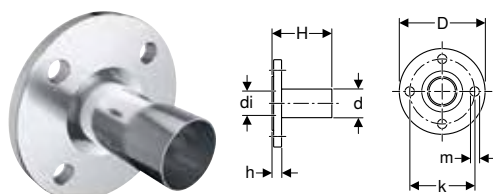

click & scan

Cod art.	DN	d, ø [mm]	di, ø [mm]	D [cm]	k [mm]	m [mm]	H [cm]	h [cm]	n [pc.]	PN [bar]	EUR/buc.
23784	20	22	19	10,5	75	14	7,9	1,8	4	10 / 16	34,25
23785	25	28	25	11,5	85	14	8,1	1,8	4	10 / 16	36,20
23786	32	35	32	14	100	18	9	1,8	4	10 / 16	53,74
23787	40	42	39	15	110	18	10,8	1,8	4	10 / 16	61,79
23788	50	54	51	16,5	125	18	11,3	1,8	4	10 / 16	63,47
23789	65	76,1	72	18,5	145	18	13,6	1,8	4	10 / 16	116,77
23790	80	88,9	84,8	20	160	18	15,2	2	8	10 / 16	136,67
23791	100	108	103,9	22	180	18	16,5	2	8	10 / 16	163,68

Accesorii

- Set șurub Geberit pentru conexiune cu flanșă, din oțel galvanizat → p. 158
- Garnitură flanșă Geberit PN 10/16, din fibre compozite → p. 157

Compensatoare

Compensator axial Geberit Mapress Oțel-Carbon, cu mufe de sertizare

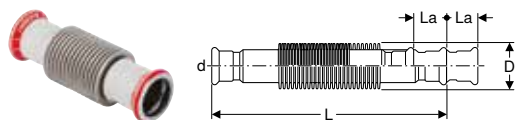

click & scan

Cod art.	DN	d, ø [mm]	D [cm]	La [mm]	L [cm]	EUR/buc.
23932	12	15	2,6	7	15,1	100,83
23933	15	18	2,6	7	14,7	102,25
23934	20	22	3,1	11	10,6	110,73
23935	25	28	3,9	13	12	119,06
23936	32	35	4,6	13	13,9	127,60
23937	40	42	5,9	13	14,9	278,51
23938	50	54	7	18	17,6	301,12
23939	65	76,1	8,8	22	26,2	367,39
23940	80	88,9	11,7	23	28,6	382,21
23941	100	108	14,4	23	54,2	902,30

Dispozitive de închidere

Capac Geberit Mapress Oțel-Carbon



click & scan

Cod art.	DN	d, ø [mm]	L [cm]	Z [cm]	EUR/buc.
20212	12	15	2,3	0,3	4,27
20213	15	18	2,3	0,3	5,15
20214	20	22	2,4	0,3	5,53
20215	25	28	2,6	0,3	6,40
20216	32	35	2,9	0,3	9,06
20217	40	42	3,3	0,3	19,16
20218	50	54	3,8	0,3	21,56
20219	65	76,1	6	0,7	35,61
20220	80	88,9	6,7	0,7	40,17
20221	100	108	8,2	0,7	51,92

Teuri pentru instalații de încălzire

Teu cruce Geberit Mapress, cu cutie izolatoare

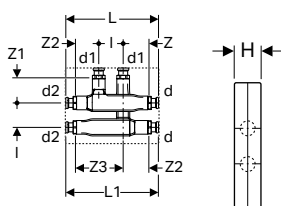

click & scan

Cod art.	DN	d, ø [mm]	d1, ø [mm]	d2, ø [mm]	arc [°]	L [cm]	L1 [cm]	l [cm]	H [cm]	Z [cm]	Z1 [cm]	Z2 [cm]	Z3 [cm]	EUR/buc.
63113	12 / 12 / 12	15	15	15	90	19	19	5	5	4,8	5,2	5,3	9,8	71,10
63115	15 / 12 / 15	18	15	18	90	19	19	5	5	4,8	5,2	5,3	9,8	78,58
63125	15 / 15 / 15	18	18	18	90	19	19	5	5	4,8	5,2	5,3	9,8	78,58
63117	20 / 12 / 20	22	15	22	90	19,2	19,2	5	5	4,8	5,2	5,3	9,8	82,32
63118	20 / 15 / 20	22	18	22	90	19,2	19,2	5	5	4,8	5,2	5,3	9,8	82,32

Racorduri pentru instalații de încălzire

Set teu racordare Geberit Mapress Oțel-Carbon pentru retur

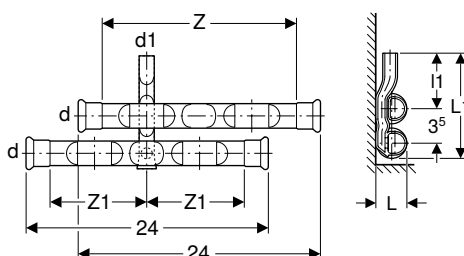

click & scan

Cod art.	DN	d, ø [mm]	d1, ø [mm]	arc [°]	L [cm]	L1 [cm]	l1 [cm]	Z [cm]	Z1 [cm]	EUR/buc.
23602	12	15	15	90	2,7	10,8	6,5	10	20	26,98
23603	15 / 12	18	15	90	2,9	11	6,5	10	20	27,89
23604	20 / 12	22	15	90	3,3	11,2	6,5	9,9	19,8	28,77

Set teuri racordare Geberit Mapress Oțel-Carbon pentru tur și retur

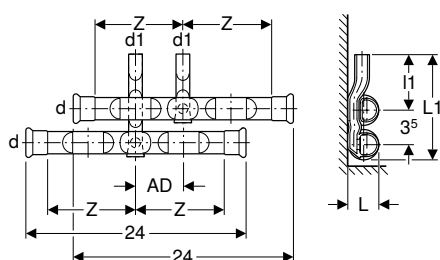

click & scan

Cod art.	DN	d, ø [mm]	d1, ø [mm]	arc [°]	AD [cm]	L [cm]	L1 [cm]	l1 [cm]	Z [cm]	EUR/buc.
24002	12	15	15	90	4-6	2,7	10,8	6,5	10	44,41
24003	15 / 12	18	15	90	4-6	2,9	11	6,5	10	45,94
24004	20 / 12	22	15	90	4-6	3,3	11,2	6,5	10	48,24

Set teuri racordare Geberit Mapress Oțel-Carbon pentru tur și retur, cu îmbinare filetată de racordare pentru eurocon

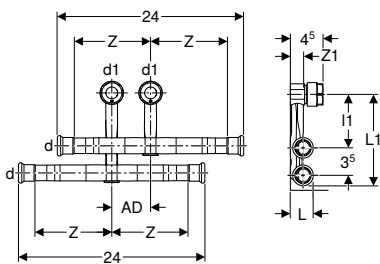

click & scan

Cod art.	DN	d, ø [mm]	d1, ø [mm]	arc [°]	AD [cm]	L [cm]	L1 [cm]	l1 [cm]	Z [cm]	Z1 [cm]	EUR/buc.
24045	12	15	15	90	5	2,7	12,6	6,8	10	1,7	58,67
24046	15 / 12	18	15	90	5	2,9	12,7	6,8	10	1,7	60,40
24047	20 / 12	22	15	90	5	3,3	13	6,8	10	1,7	63,05



• Îmbinarea filetată se strânge până la limită

Îmbinare filetată de racord Geberit pentru eurocon

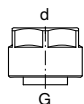

click & scan

Cod art.	DN	d, ø [mm]	G ["]	EUR/buc.
25073	12 / 20	15	3/4"	3,96



• Îmbinarea filetată se strânge până la limită

Racord Geberit Mapress Oțel-Carbon, cu piuliță

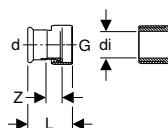

click & scan

Cod art.	DN	d, ø [mm]	G ["]	di, ø [mm]	L [cm]	Z [cm]	EUR/buc.
25042	12	15	1/2"	10	5,1	2,5	7,79
25048	15	18	1/2"	10	5,3	2,6	8,74
25049	20	22	3/4"	13	5,4	2,7	9,20

Accesorii pentru Geberit Mapress Oțel-Carbon

Etanșări pentru țevi și fittinguri

Bandă de etanșare Geberit

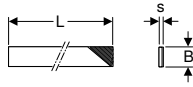
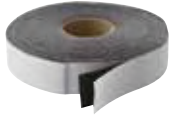

click & scan
EUR/buc.

Cod art.	S [mm]	L [m]	B [cm]	EUR/buc.
601.813.00.1	1	12,5	3	31,41
601.815.00.1	1	12,5	5	52,06



- Montare după încercare la presiune

Dispozitive de fixare pentru țevi

Brățară pentru conductă Geberit, izolată, cu piuliță conector M8 / M10

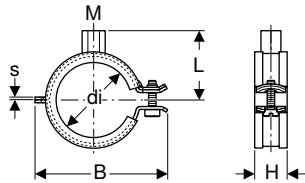

click & scan

Cod art.	Culoare/suprafață	M [mm]	di, \varnothing [mm]	L [cm]	B [cm]	H [cm]	EUR/buc.
601.851.26.1	Galvanizat	8 / 10	15–19	3,1	5,2	2,3	1,75
601.852.26.1	Galvanizat	8 / 10	20–24	3,4	5,6	2,3	1,75
601.853.26.1	Galvanizat	8 / 10	25–30	3,6	6,3	2,3	1,86
601.854.26.1	Galvanizat	8 / 10	32–37	3,9	6,8	2,3	2,00
601.855.26.1	Galvanizat	8 / 10	40–46	4,3	7,6	2,3	2,12
601.857.26.1	Galvanizat	8 / 10	54–58	4,8	8,9	2,3	2,61
601.858.26.1	Galvanizat	8 / 10	63–67	5,5	10	2,3	3,34
601.859.26.1	Galvanizat	8 / 10	74–80	6,4	11,9	2,3	3,61
601.860.26.1	Galvanizat	8 / 10	83–91	6,8	13	2,3	3,74
601.861.26.1	Galvanizat	8 / 10	108–114	8,1	15,3	2,8	4,23

Niplu dublu Geberit M10 / G 1/2"

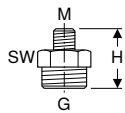

click & scan
EUR/buc.

Cod art.	Culoare/suprafață	G ["]	M [mm]	H [cm]	SW [mm]	EUR/buc.
362.856.26.1	Galvanizat	1/2"	10	2,8	22	5,60

Tijă filetată Geberit

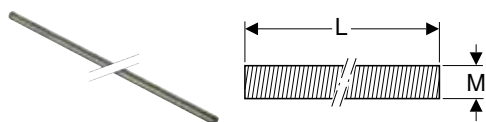

click & scan
EUR/buc.

Cod art.	Culoare/suprafață	M [mm]	L [cm]	
362.834.26.1	Galvanizat	10	200	6,83

Țeavă filetată Geberit

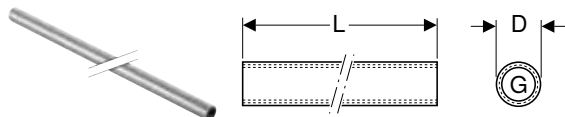

click & scan
EUR/buc.

Cod art.	G [""]	D [cm]	L [cm]	
362.857.26.1	1/2"	2,5	115	38,24

Placă de fixare Geberit dreptunghiulară, două orificii, cu piuliță conector M8/M10

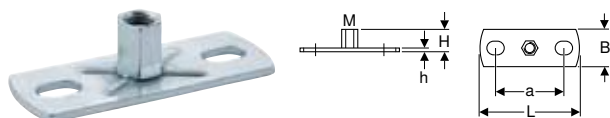

click & scan
EUR/buc.

Cod art.	M [mm]	a [cm]	L [cm]	B [cm]	H [cm]	h [cm]	
362.848.26.1	8 / 10	5,4	8	3	1,9	0,3	3,81

Placă de fixare Geberit dreptunghiulară, două orificii, cu piuliță conector M10/G 1/2"

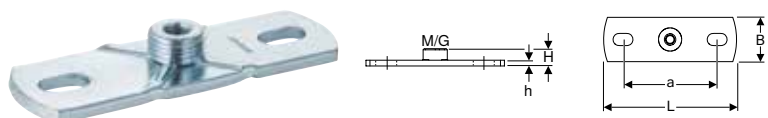

click & scan
EUR/buc.

Cod art.	G [""]	M [mm]	a [cm]	L [cm]	B [cm]	H [cm]	h [cm]	
362.851.26.1	1/2"	10	8,5	12	4	1,5	0,5	4,68

Dispozitive de fixare pentru racorduri

Dispozitiv de fixare pentru cot adaptor Geberit Mapress 90°

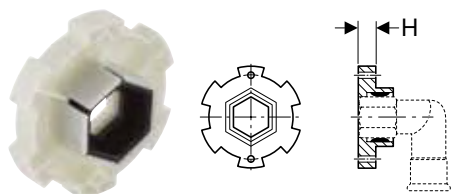

click & scan

Cod art.	H [cm]		EUR/buc.
90282	1,3		6,81

Garnituri de sistem

O-ring Geberit Mapress CIIR negru



click & scan

Cod art.	DN	d, ø [mm]	EUR/buc.
90401	10	12	0,34
90402	12	15	0,36
90403	15	18	0,47
90404	20	22	0,47
90405	25	28	0,55
90406	32	35	0,55
90407	40	42	0,84
90408	50	54	0,84
90412	65	66,7	2,01
90409	65	76,1	2,40
90410	80	88,9	3,27
90411	100	108	6,29

O-ring Geberit Mapress FKM albastru



click & scan

Cod art.	DN	d, ø [mm]	EUR/buc.
90881	10	12	2,43
90882	12	15	1,02
90883	15	18	1,24
90884	20	22	1,55
90885	25	28	1,84
90886	32	35	2,14
90887	40	42	3,82
90888	50	54	5,38
90891	65	76,1	15,71
90892	80	88,9	19,73
90893	100	108	43,93

Garnitură plată Geberit Mapress EPDM neagră

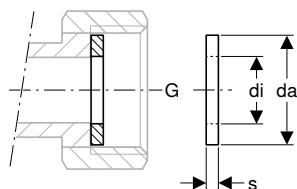

click & scan

Cod art.	G ["]	da [mm]	di, ø [mm]	s [mm]	EUR/buc.
90081	3/4"	24	13	2	1,92
90082	1"	30	19,6	2	1,92
90083	1 1/4"	39	25,6	2	1,92
90084	1 1/2"	45	32	2	1,92
90085	1 3/4"	50	39	2	1,92
90086	2 3/8"	66	51	3	1,92
90088	N 3"	84,7	76	3	2,40
90089	N 3 1/2"	97	84	3	2,89

N: Nou, livrabil din April 2024

Garnitură plată Geberit Mapress FPM verde

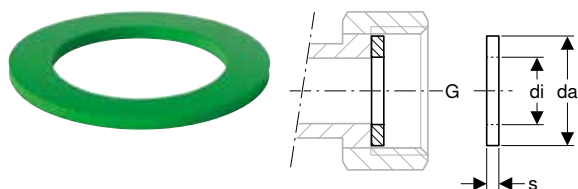

click & scan

Cod art.	G ["]	da [mm]	di, ø [mm]	s [mm]	EUR/buc.
90092	3/4"	24	13	2	2,01
90094	1"	30	19,6	2	3,03
90095	1 1/4"	39	25,6	2	3,03
90096	1 1/2"	45	32	2	3,96
90097	1 3/4"	50	39	2	3,96
90098	2 3/8"	66	51	2	10,35

Nou

Garnitură plată Geberit Mapress, din fibre compozite



click & scan
EUR/buc.

Cod art.	G ["]	da [mm]	di, ø [mm]	s [mm]	EUR/buc.
600.079.00.1	1/2"	18,4	10	2	1,11
600.080.00.1	3/4"	23,9	13	2	1,34
600.081.00.1	1"	30	19,6	2	1,47
600.082.00.1	1 1/8"	34,7	21	2	1,56
600.083.00.1	1 1/4"	38	25	2	1,78
600.084.00.1	1 1/4"	38,7	25,6	2	1,78
600.085.00.1	1 1/2"	44,6	32	2	1,93
600.087.00.1	1 3/4"	50,5	39	2	2,11
600.088.00.1	2"	56,4	42	2	2,22
600.089.00.1	2 1/4"	62,5	42	2	2,33
600.090.00.1	2 3/8"	66,2	51	2	2,67
600.091.00.1	2 1/2"	72	54	2	3,00
600.092.00.1	2 3/4"	78,3	57	2	3,33
600.093.00.1	3"	84,7	72,1	2	3,66
600.094.00.1	3 1/2"	97,1	84,9	2	4,00

Livrabil din April 2024



- Produs înlocuitor pentru cod art. 90072, 90074, 90075, 90076, 90077, 90078

Nou

Garnitură flanșă Geberit PN 6, din fibre compozite



click & scan
EUR/buc.

Cod art.	DN	da [mm]	di, ø [mm]	s [mm]	PN [bar]	
600.051.00.1	15	44	20	2	6	1,67
600.052.00.1	20	54	25	2	6	1,87
600.053.00.1	25	64	30	2	6	2,22
600.054.00.1	32	76	38	2	6	2,64
600.055.00.1	40	86	45	2	6	3,15
600.056.00.1	50	96	57	2	6	3,73
600.057.00.1	65	116	76	2	6	4,68
600.058.00.1	80	132	89	2	6	5,61
600.059.00.1	100	152	108	2	6	6,72

Livrabil din April 2024



- Produs înlocuitor pentru cod art. 91041, 91042, 91043, 91044, 91045, 91046, 91047, 91048, 91049

Nou

Garnitură flanșă Geberit PN 10/16, din fibre compozite



click & scan
EUR/buc.

Cod art.	DN	da [mm]	di, ø [mm]	s [mm]	PN [bar]	
600.041.00.1	15	50	20	2	10 / 16	1,89
600.042.00.1	20	60	25	2	10 / 16	2,11
600.043.00.1	25	70	30	2	10 / 16	2,51
600.044.00.1	32	82	38	2	10 / 16	2,98
600.045.00.1	40	92	45	2	10 / 16	3,55
600.046.00.1	50	107	57	2	10 / 16	4,22
600.047.00.1	65	127	76	2	10 / 16	5,28
600.048.00.1	80	142	89	2	10 / 16	6,34
600.049.00.1	100	162	108	2	10 / 16	7,61

Livrabil din April 2024



- Produs înlocuitor pentru cod art. 91031, 91032, 91033, 91034, 91035, 91036, 91037, 91038, 91039



Seturi de șuruburi pentru conexiuni cu flanșă

Set șurub Geberit pentru conexiune cu flanșă, din oțel galvanizat

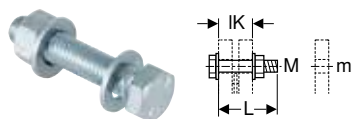

click & scan
 EUR/buc.

Cod art.	M [mm]	m [mm]	L [cm]	IK [cm]	
91064	10	11	4,5	3,1	2,01
91065	10	11	5	3,6	2,01
91066	12	14	5	3	2,16
91067	12	14	5,5	3,5	2,16
91068	12	14	6	4	2,16
91069	16	18	5,5	3,3	3,93
91070	16	18	6	3,8	3,93
91071	16	18	6,5	4,3	3,93
91072	16	18	7	4,8	3,93
91073	16	18	8	5,8	3,93





Geberit Mapress Cupru

Vedere de ansamblu asupra utilizărilor – Geberit Mapress Cupru.	239
Geberit Mapress Cupru.....	240
Mufe	240
Reducții	241
Coturi	242
Teuri	244
Elemente în cruce	245
Adaptoare, fără posibilitate de desfacere	246
Adaptoare și conexiuni, cu posibilitate de desfacere	249
Dispozitive de închidere	251
Racorduri	252
Teuri pentru instalații de încălzire	253
Racorduri pentru instalații de încălzire	253
Accesorii pentru Geberit Mapress Cupru.....	255
Izolații pentru racorduri.....	255
Etanșări pentru țevi și fittinguri	255
Dispozitive de fixare pentru țevi	256
Dispozitive de fixare pentru racorduri.....	257
Garnituri de sistem	259
Seturi de șuruburi pentru conexiuni cu flanșă	262



Vedere de ansamblu asupra utilizărilor – Geberit Mapress Cupru

Geberit România, Versiune: December 2023

Domenii de utilizare	Temperatură de operare	Presiunea maximă de exploatare	Țevi	Fitinguri			
			Cupru	Indicator alb de cupru	Alamă roșie indicator alb	Alamă indicator alb	Oțel carbon placat cu cupru
Medii fluide							
Pentru apă potabilă rece și caldă	0–100 °C	16 bar / 1600 kPa ⁵⁾	✓	✓	✓		
Pentru apă de răcire și de încălzire fără antigel	0–100 °C	16 bar / 1600 kPa	✓	✓	✓	✓	✓
Pentru apă de răcire și de încălzire fără antigel	-30 – +120 °C	16 bar / 1600 kPa	✓	✓	✓	✓	✓
Pentru agent termic de termoficare ≤ 120 °C	0–120 °C	16 bar / 1600 kPa	✓	✓	✓	✓	
Pentru apa de operare și de proces	0–100 °C	16 bar / 1600 kPa	7)	7)	7)	7)	
Pentru agenți termici (solar)	-25 – +220 °C ³⁾⁴⁾	10 bar / 1000 kPa	✓	✓	✓	✓	
Pentru uleiuri minerale și de lubrifiere	La cerere	La cerere	7)	7)	7)		
Pentru combustibili (de ex. diesel)	La cerere	La cerere	7)	7)	7)		
Medii gazoase							
Pentru aer comprimat (clasa de puritate ulei 2-3) ¹⁾	0–100 °C	12 bar/1200 kPa ⁵⁾	✓	✓	✓		
Pentru aer comprimat (clasă de puritate ulei 0-X) ¹⁾	0–100 °C	12 bar/1200 kPa ⁵⁾	✓	✓	✓		
Pentru presiune negativă ²⁾	0–100 °C	Abs. ≥ 0,2 bar/20 kPa	✓	✓	✓		
Pentru gaze inerte (de ex. azot)	0–100 °C	12 bar/1200 kPa ⁵⁾	✓	✓	✓	✓	
Pentru gaz metan	-20 – +70 °C	MOP 5 / GT 1	✓	✓	✓	✓	
Pentru gaze lichefiate	-20 – +70 °C	MOP 5 / GT 1	✓	✓	✓	✓	

✓ Utilizare generală aprobată, dacă sunt îndeplinite condițiile suplimentare definite conform notelor de subsol

¹⁾ Presiune negativă utilă pentru țevile Geberit:

Presiunea negativă utilă rezultă din presiunea aerului la locul de instalație minus presiunea absolută de 200 mbar.

Exemplu: Presiunea aerului 980 mbar - presiunea absolută 200 mbar = presiunea negativă utilă în sistemul de conducte 780 mbar

²⁾ Presiune negativă utilizabilă pentru sisteme de conducte Geberit:

Presiunea negativă utilizabilă rezultă din presiunea aerului la locul de instalare minus presiunea absolută de 200 mbar.

Exemplu: presiunea aerului 980 mbar - presiune absolută 200 mbar = presiune negativă utilizabilă pe sistemul de conducte 780 mbar

³⁾ Durată de viață cu colectorul oprit: 200 h/a la 180 °C; 60 h/a la 200 °C; total 500 h/durată de viață la 220 °C

⁴⁾ Utilizarea inhibitorilor, a agenților de protecție împotriva coroziunii, a agenților de protecție la îngheț numai după aprobarea Geberit

⁵⁾ 10 bar / 1000 kPa pentru MasterFix și MeplaFix

⁶⁾ Activat până la d54 mm

⁷⁾ Following Geberit approval

⁸⁾ Utilizarea inhibitorilor, a agenților de protecție împotriva coroziunii, a agenților de protecție la îngheț numai după aprobarea Geberit

⁹⁾ Clasă de puritate a uleiului conform ISO 8573-1:2010E; pentru detalii referitoare la umiditate și particule, vezi Informațiile tehnice "Sisteme de conducte Geberit pentru instalații de aer comprimat"



- Pentru fiecare aplicație se vor respecta condițiile de utilizare din autorizațiile de referință, norme și reglementări tehnice. Ele pot diferi de datele specificate

	Inele de etanșare				Garnituri plate pentru îmbinări filetate			Garnituri de flanșă
	CIIR negru	EPDM negru	FKM albastru	HNBR galben	EPDM negru	FPM verde	Fibre compozite	Fibre compozite
	✓	✓			✓		✓	✓
	✓ ⁸⁾	✓			✓		✓	✓
	✓ ⁸⁾						✓	✓
	✓ ⁸⁾	✓				✓	✓	✓
	7)	7)			7)		7)	7)
			✓			✓	✓	✓
			7)			7)	7)	7)
			7)			7)	7)	7)
	✓ ⁹⁾				✓ ⁹⁾		✓	✓
			✓ ⁹⁾			✓ ⁹⁾	✓	✓
	✓	✓					✓	✓
	✓				✓		✓	✓
				✓			✓	✓
				✓			✓	✓



Geberit Mapress Cupru

Mufe

Mufă Geberit Mapress Cupru



click & scan
EUR/buc.

Cod art.	DN	d, ø [mm]	L [cm]	Z [cm]	EUR/buc.
62001	10	12	4,2	0,8	3,10
62002	12	15	4,8	0,8	3,63
62003	15	18	4,8	0,8	4,05
62004	20	22	5	0,8	4,44
62005	25	28	5,4	0,8	7,37
62006	32	35	6,2	1	9,28
62007	40	42	7,1	1,1	16,57
62008	50	54	8,3	1,3	20,60
62011	65	76,1	12,7	2,1	53,71
62012	80	88,9	14,5	2,5	61,06
62013	100	108	17,6	2,6	92,16

Mufă Geberit Mapress Cupru, redusă



click & scan
EUR/buc.

Cod art.	DN	d, ø [mm]	d1, ø [mm]	L [cm]	Z [cm]	EUR/buc.
62050	12 / 10	15	12	4	0,3	11,61
62055	20 / 12	22	15	4,4	0,3	12,06

Mufă de inserție Geberit Mapress Cupru

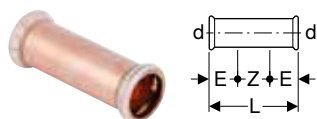

click & scan
EUR/buc.

Cod art.	DN	d, ø [mm]	E [cm]	L [cm]	Z [cm]	EUR/buc.
62102	12	15	2,5	8	3	13,60
62103	15	18	2,5	8	3	15,36
62104	20	22	2,5	8,4	3,4	15,68
62105	25	28	3	9,1	3,1	19,68
62106	32	35	3	10,2	4,2	24,86
62107	40	42	4	12	4	34,37
62108	50	54	4	14	6	37,00
62111	65	76,1	5,3	23	12,4	94,54
62112	80	88,9	6	26	14	115,59
62113	100	108	7,5	31	16	136,89

Reducții

Reducție Geberit Mapress Cupru, cu capăt drept

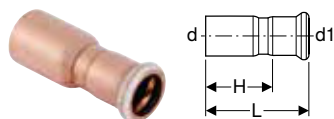

click & scan
EUR/buc.

Cod art.	DN	d, ø [mm]	d1, ø [mm]	L [cm]	H [cm]	
62301	12 / 10	15	12	5	3,3	2,44
62302	15 / 10	18	12	5,4	3,7	2,61
62303	15 / 12	18	15	5,5	3,5	2,61
62305	20 / 12	22	15	5,9	3,9	2,79
62306	20 / 15	22	18	5,7	3,7	2,79
62307	25 / 12	28	15	6,6	4,6	7,26
62308	25 / 15	28	18	6,4	4,4	7,26
62309	25 / 20	28	22	6	3,9	7,26
62312	32 / 20	35	22	7,1	5	8,94
62313	32 / 25	35	28	6,8	4,5	8,94
62316	40 / 20	42	22	8,1	6	14,55
62317	40 / 25	42	28	7,9	5,6	14,55
62318	40 / 32	42	35	7,6	5	14,55
62322	50 / 25	54	28	9,7	7,4	18,99
62323	50 / 32	54	35	9,6	7	18,99
62324	50 / 40	54	42	9,2	6,1	18,99
62329	65 / 32	76,1	35	12,6	10	65,58
62330	65 / 40	76,1	42	12,6	9,6	65,58
62331	65 / 50	76,1	54	14,6	11,1	65,58
62332	65 / 65	76,1	66,7	15,1	10,1	65,58
62333	80 / 40	88,9	42	14	11	76,26
62334	80 / 50	88,9	54	16,2	12,8	76,26
62336	80 / 65	88,9	76,1	16,1	10,8	76,26
62337	100 / 40	108	42	17,3	14,3	94,54
62338	100 / 50	108	54	17,3	13,8	94,54
62339	100 / 65	108	66,7	18,9	13,9	112,81
62340	100 / 65	108	76,1	18,4	13,1	112,81
62341	100 / 80	108	88,9	20,3	14,3	112,81



Coturi

Cot Geberit Mapress Cupru

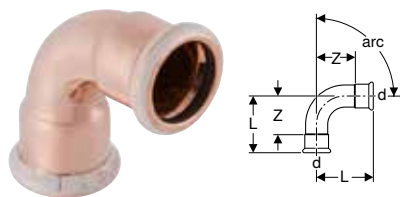

click & scan

Cod art.	DN	d, \emptyset [mm]	L [cm]	Z [cm]	EUR/buc.
arc / cot: 45°					
60601	10	12	2,6	0,9	3,10
60602	12	15	2,8	0,8	3,44
60603	15	18	2,9	0,9	3,76
60604	20	22	3,2	1,1	4,69
60605	25	28	3,7	1,4	8,94
60606	32	35	4	1,4	17,57
60607	40	42	4,7	1,7	33,12
60608	50	54	5,7	2,2	46,03
60611	65	76,1	10,3	5	115,91
60612	80	88,9	11,7	5,7	137,20
60613	100	108	14,3	6,8	228,71
arc / cot: 90°					
60101	10	12	3,1	1,4	3,10
60102	12	15	3,8	1,8	3,44
60103	15	18	4,2	2,2	3,76
60104	20	22	4,7	2,6	4,69
60105	25	28	5,7	3,4	8,94
60106	32	35	6,5	3,9	17,57
60107	40	42	7,6	4,6	33,12
60108	50	54	9,5	6	46,03
60111	65	76,1	15,9	10,6	115,91
60112	80	88,9	18,5	12,5	137,20
60113	100	108	23	15,5	228,71

Cot Geberit Mapress Cupru, cu capăt drept

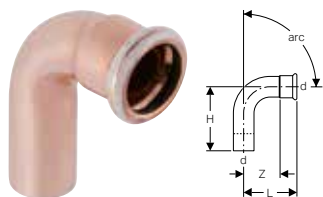

click & scan

Cod art.	DN	d, \emptyset [mm]	L [cm]	H [cm]	Z [cm]	EUR/buc.
arc / cot: 45°						
60701	10	12	2,6	3,5	0,9	3,10
60702	12	15	2,8	3,8	0,8	3,44
60703	15	18	2,9	3,9	0,9	3,76
60704	20	22	3,2	4,4	1,1	4,69
60705	25	28	3,7	4,5	1,2	8,94
60706	32	35	4	4,9	1,4	17,57
60707	40	42	4,7	5,7	1,7	33,12
60708	50	54	5,7	6,8	2,2	46,03
60711	65	76,1	10,3	11,1	5	115,91
60712	80	88,9	11,7	12,8	5,7	137,20
60713	100	108	14,3	15,8	6,8	228,71
arc / cot: 90°						
60301	10	12	3,1	4,5	1,4	3,10
60302	12	15	3,8	5,1	1,8	3,44
60303	15	18	4,2	5,3	2,2	3,76
60304	20	22	4,7	6	2,6	4,69
60305	25	28	5,7	6,5	3,4	8,94
60306	32	35	6,5	7,4	3,9	17,57

Cod art.	DN	d, ø [mm]	L [cm]	H [cm]	Z [cm]	EUR/buc.
60307	40	42	7,6	8,6	4,6	33,12
60308	50	54	9,5	10,6	6	46,03
60311	65	76,1	15,9	16,7	10,6	115,91
60312	80	88,9	18,5	19,5	12,5	137,20
60313	100	108	23	24,1	15,5	228,71

Cot de adaptare Geberit Mapress Cupru

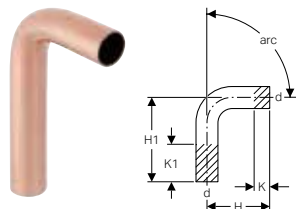

click & scan

Cod art.	DN	d, ø [mm]	H [cm]	H1 [cm]	K [cm]	K1 max. [cm]	EUR/buc.
arc / cot: 15°							
60905	25	28	4,3	11,9	0	7,6	10,05
60906	32	35	4,1	11,8	0	7,7	20,14
60907	40	42	4,7	13,7	0	9	29,60
60908	50	54	5,5	14,9	0	9,4	44,38
arc / cot: 30°							
60935	25	28	4,8	12,4	0	7,6	10,05
60936	32	35	4,6	12,3	0	7,7	20,14
60937	40	42	5,4	14,4	0	9	29,60
60938	50	54	6,3	15,7	0	9,4	44,38
arc / cot: 45°							
60875	25	28	4,5	11,8	0	7,3	10,05
60876	32	35	4,9	12,6	0	7,7	20,14
60877	40	42	5,7	14,7	0	9	29,60
60878	50	54	6,8	16,2	0	9,4	44,38
arc / cot: 60°							
60955	25	28	6,1	13,7	0	7,6	10,05
60956	32	35	5,9	13,6	0	7,7	20,14
60957	40	42	6,9	15,9	0	9	29,60
60958	50	54	8,3	17,7	0	9,4	44,38
arc / cot: 90°							
60082	12	15	5,1	11,8	0	6,7	4,14
60083	15	18	5,3	12,2	0	6,9	5,37
60084	20	22	6	12,8	0	6,8	6,21
60085	25	28	6,5	14	0	7,5	10,05
60086	32	35	7,4	15,1	0	7,7	20,14
60087	40	42	8,6	17,6	0	9	29,60
60088	50	54	10,6	20	0	9,4	44,38

Cot în S Geberit Mapress Cupru

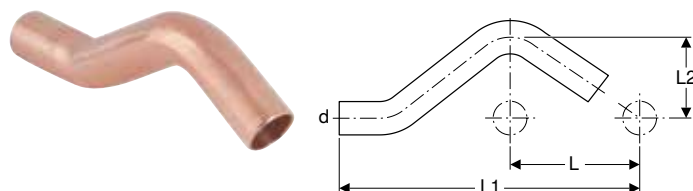

click & scan

Cod art.	DN	d, ø [mm]	L [cm]	L1 [cm]	L2 [cm]	EUR/buc.
60802	12	15	6	16,5	3,2	6,34
60803	15	18	6	16,6	3,3	9,37
60804	20	22	6	16,8	3,5	12,30

Teuri

Teu Geberit Mapress Cupru, egal

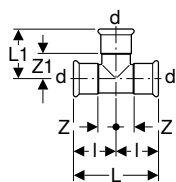

click & scan

Cod art.	DN	d, ø [mm]	arc [°]	L [cm]	L1 [cm]	I [cm]	Z [cm]	Z1 [cm]	EUR/buc.
61000	10	12	90	6,2	3,1	3,1	1,4	1,4	5,25
61002	12	15	90	6,4	3,1	3,2	1,2	1,2	5,56
61003	15	18	90	6,8	3,4	3,4	1,4	1,4	5,82
61004	20	22	90	7,4	3,7	3,7	1,6	1,6	7,06
61005	25	28	90	8,4	4,2	4,2	1,9	1,9	12,94
61006	32	35	90	10	5,9	5	2,4	3,3	20,99
61007	40	42	90	11,4	6,6	5,7	2,7	3,6	39,16
61008	50	54	90	13,8	7,8	6,9	3,4	4,3	53,52
61011	65	76,1	90	23	11	11,5	6,2	5,7	164,67
61012	80	88,9	90	26	12,7	13	7	6,7	195,14
61013	100	108	90	31	15,3	15,5	8	7,8	216,47

Teu Geberit Mapress Cupru, redus

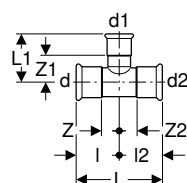

click & scan

Cod art.	DN	d, ø [mm]	d1, ø [mm]	d2, ø [mm]	arc [°]	L [cm]	L1 [cm]	I [cm]	I2 [cm]	Z [cm]	Z1 [cm]	Z2 [cm]	EUR/buc.
61252	12 / 10 / 12	15	12	15	90	6,4	3,3	3,2	3,2	1,2	1,6	1,2	5,56
61104	12 / 20 / 12	15	22	15	90	7,4	3,4	3,7	3,7	1,7	1,3	1,7	7,06
61253	15 / 10 / 15	18	12	18	90	6,8	3,5	3,4	3,4	1,4	1,8	1,4	5,82
61235	15 / 12 / 12	18	15	15	90	7,4	3,5	3,4	4	1,4	1,5	2	5,82
61254	15 / 12 / 15	18	15	18	90	6,8	3,5	3,4	3,4	1,4	1,5	1,4	5,82
61236	15 / 15 / 12	18	18	15	90	7,4	3,4	3,4	4	1,4	1,4	2	5,82
61244	20 / 10 / 20	22	12	22	90	7,4	3,5	3,7	3,7	2,1	1,7	2,1	6,72
61240	20 / 12 / 12	22	15	15	90	8	3,8	3,7	4,3	1,6	1,8	2,3	7,06
61256	20 / 12 / 20	22	15	22	90	7,4	3,8	3,7	3,7	1,6	1,8	1,6	7,06
61257	20 / 15 / 20	22	18	22	90	7,4	3,8	3,7	3,7	1,6	1,8	1,6	7,06
61242	20 / 20 / 12	22	22	15	90	7,4	3,7	3,7	4,5	1,6	1,6	2,5	7,06
61259	25 / 12 / 25	28	15	28	90	8,4	4,1	4,2	4,2	1,9	2,1	1,9	12,94
61260	25 / 15 / 25	28	18	28	90	8,4	4,1	4,2	4,2	1,9	2,1	1,9	12,94
61261	25 / 20 / 25	28	22	28	90	8,4	4,1	4,2	4,2	1,9	2	1,9	12,94
61212	32 / 12 / 32	35	15	35	90	10	5,1	5	5	2,4	3,1	2,4	20,99
61213	32 / 15 / 32	35	18	35	90	10	5	5	5	2,4	3	2,4	20,99
61214	32 / 20 / 32	35	22	35	90	10	5,2	5	5	2,4	3,1	2,4	20,99
61215	32 / 25 / 32	35	28	35	90	10	5,5	5	5	2,4	3,2	2,4	20,99
61229	40 / 12 / 40	42	15	42	90	11,4	5,4	5,7	5,7	2,7	3,4	2,7	39,16
61217	40 / 15 / 40	42	18	42	90	11,4	5,4	5,7	5,7	2,7	3,4	2,7	39,16
61218	40 / 20 / 40	42	22	42	90	11,4	5,5	5,7	5,7	2,7	3,4	2,7	39,16
61219	40 / 25 / 40	42	28	42	90	11,4	5,8	5,7	5,7	2,7	3,5	2,7	39,16
61220	40 / 32 / 40	42	35	42	90	11,4	6,2	5,7	5,7	2,7	3,6	2,7	39,16
61227	50 / 20 / 50	54	22	54	90	13,8	6,1	6,9	6,9	3,4	4	3,4	53,52
61228	50 / 25 / 50	54	28	54	90	13,8	6,4	6,9	6,9	3,4	4,1	3,4	53,52
61225	50 / 32 / 50	54	35	54	90	13,8	6,8	6,9	6,9	3,4	4,2	3,4	53,52
61226	50 / 40 / 50	54	42	54	90	13,8	7,2	6,9	6,9	3,4	4,2	3,4	53,52
61283	65 / 20 / 65	76,1	22	76,1	90	23	7,2	11,5	11,5	6,2	5,1	6,2	152,48
61284	65 / 32 / 65	76,1	35	76,1	90	23	7,9	11,5	11,5	6,2	5,3	6,2	152,48
61285	65 / 40 / 65	76,1	42	76,1	90	23	8,3	11,5	11,5	6,2	5,3	6,2	152,48
61286	65 / 50 / 65	76,1	54	76,1	90	23	8,9	11,5	11,5	6,2	5,4	6,2	152,48
61287	65 / 65 / 65	76,1	66,7	76,1	90	23	11	11,5	11,5	6,2	6	6,2	164,67

Cod art.	DN	d, ø [mm]	d1, ø [mm]	d2, ø [mm]	arc [°]	L [cm]	L1 [cm]	l [cm]	l2 [cm]	Z [cm]	Z1 [cm]	Z2 [cm]	EUR/buc.
61288	80 / 20 / 80	88,9	22	88,9	90	26	7,8	13	13	7	5,7	7	183,00
61289	80 / 40 / 80	88,9	42	88,9	90	26	8,9	13	13	7	5,9	7	183,00
61290	80 / 50 / 80	88,9	54	88,9	90	26	9,5	13	13	7	6	7	183,00
61292	80 / 65 / 80	88,9	76,1	88,9	90	26	11,6	13	13	7	6,3	7	195,14
61293	100 / 20 / 100	108	22	108	90	31	8,8	15,5	15,5	8	6,7	8	198,24
61294	100 / 50 / 100	108	54	108	90	31	10,5	15,5	15,5	8	7	8	198,24
61295	100 / 65 / 100	108	66,7	108	90	31	12,6	15,5	15,5	8	7,6	8	216,47
61296	100 / 65 / 100	108	76,1	108	90	31	12,6	15,5	15,5	8	7,3	8	216,47
61297	100 / 80 / 100	108	88,9	108	90	31	13,7	15,5	15,5	8	7,7	8	216,47

Teu Geberit Mapress Cupru, cu filet interior

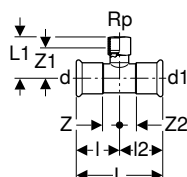

click & scan

Cod art.	DN	d, ø [mm]	Rp [°]	d1, ø [mm]	arc [°]	L [cm]	L1 [cm]	l [cm]	l2 [cm]	Z [cm]	Z1 [cm]	Z2 [cm]	EUR/buc.
61352	10 / 15 / 10	12	1/2"	12	90	6,8	2,4	3,4	3,4	1,7	1,1	1,7	18,01
61354	12 / 15 / 12	15	1/2"	15	90	6,8	2,6	3,4	3,4	1,4	1,3	1,4	18,35
61355	15	18	1/2"	18	90	8,2	2,4	4,1	4,1	2,1	1,1	2,1	18,61
61357	20 / 15 / 20	22	1/2"	22	90	8,4	2,6	4,2	4,2	2,1	1,3	2,1	19,18
61395	20	22	3/4"	22	90	9	2,7	4,5	4,5	2,4	1,2	2,4	18,35
61359	25 / 15 / 25	28	1/2"	28	90	8,8	2,9	4,4	4,4	2,1	1,6	2,1	21,61
61360	25 / 20 / 25	28	3/4"	28	90	8,4	3,5	4,2	4,2	1,9	2	1,9	21,61
61362	32 / 15 / 32	35	1/2"	35	90	10	3,5	5	5	2,4	2,2	2,4	30,81
61366	40 / 15 / 40	42	1/2"	42	90	11,4	3,8	5,7	5,7	2,7	2,5	2,7	37,91
61370	50 / 15 / 50	54	1/2"	54	90	13,8	4,4	6,9	6,9	3,4	3,1	3,4	46,03

Elemente în cruce

Element în cruce Geberit Mapress Cupru 30°, redus

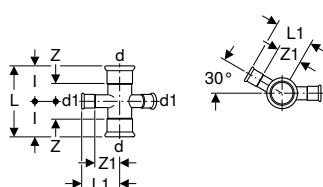

click & scan

Cod art.	DN	d, ø [mm]	d1, ø [mm]	arc [°]	L [cm]	L1 [cm]	l [cm]	Z [cm]	Z1 [cm]	EUR/buc.
61404	15 / 12	18	15	30	6,8	3,9	3,4	1,4	2,2	27,49
61406	20 / 12	22	15	30	7,4	4,4	3,7	1,6	2,4	29,15
61409	25 / 12	28	15	30	8,4	4,7	4,2	1,9	2,7	37,07

Element în cruce Geberit Mapress Cupru, redus, montat

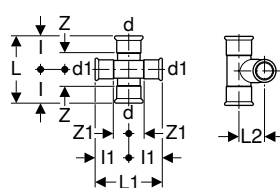

click & scan

Cod art.	DN	d, ø [mm]	d1, ø [mm]	arc [°]	L [cm]	L1 [cm]	L2 [cm]	l [cm]	l1 [cm]	Z [cm]	Z1 [cm]	EUR/buc.
61504	12	15	15	90	10,8	10,8	2,5	5,4	5,4	3,4	3,4	27,49
61505	15 / 12	18	15	90	10,8	10,8	2,5	5,4	5,4	3,4	3,4	27,49
61506	20 / 12	22	15	90	10,8	11	2,5	5,4	5,5	3,4	3,4	29,15

Adaptoare, fără posibilitate de desfacere

Mufă de adaptare Geberit Mapress Cupru



click & scan
EUR/buc.

Cod art.	DN	d, ø [mm]	d1, ø [mm]	L [cm]	Z [cm]	
62024	15	18	16	4,1	0,1	19,31

Nou

Adaptor Geberit FlowFit la Geberit Mapress, cu capăt drept

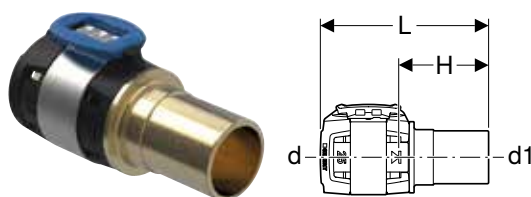

click & scan

Cod art.	DN	d, ø [mm]	d1, ø [mm]	L [cm]	H [cm]	EUR/buc.
620.230.00.1	12 / 10	16	12	6,8	3,5	7,72
620.240.00.1	12	16	15	6,9	3,6	7,72
620.231.00.1	15 / 12	20	15	6,9	3,6	9,96
620.241.00.1	15	20	18	6,9	3,6	9,96
620.242.00.1	15 / 20	20	22	7	3,7	9,96
620.232.00.1	20	25	22	7	3,7	13,82
620.233.00.1	25	32	28	7,7	4,1	18,82
620.234.00.1	32	40	35	8	4,4	22,11
620.235.00.1	40	50	42	12,8	6,9	49,75
620.236.00.1	50	63	54	13,8	7,5	77,37

Livrabil din April 2024

Adaptor Geberit Mapress Cupru, cu filet exterior



click & scan
EUR/buc.

Cod art.	DN	d, ø [mm]	R ["]	L [cm]	H [cm]	EUR/buc.
61701	10	12	3/8"	3,2	1,5	3,68
61745	10 / 15	12	1/2"	3,6	1,9	3,68
61702	12 / 10	15	3/8"	3,3	1,3	4,60
61703	12 / 15	15	1/2"	3,6	1,6	4,60
61714	12 / 20	15	3/4"	3,8	1,8	4,60
61704	15	18	1/2"	3,7	1,7	6,08
61705	15 / 20	18	3/4"	3,8	1,8	6,08
61715	20 / 15	22	1/2"	3,8	1,7	6,72
61707	20	22	3/4"	3,9	1,8	6,72
61716	20 / 25	22	1"	4,1	2	6,72
61717	25 / 20	28	3/4"	4,2	1,9	9,42
61708	25	28	1"	4,3	2	9,42
61718	25 / 32	28	1 1/4"	4,4	2,1	9,42
61719	32 / 25	35	1"	4,8	2,2	19,62
61709	32	35	1 1/4"	4,9	2,3	19,62
61721	40 / 32	42	1 1/4"	5,8	2,8	28,87
61710	40	42	1 1/2"	5,8	2,8	28,87
61711	50	54	2"	6,3	2,8	42,62
61732	65	76,1	2 1/2"	10,1	4,8	195,14
61733	65 / 80	76,1	3"	10,6	5,3	195,14
61734	80	88,9	3"	11	5	243,91

Adaptor Geberit Mapress Cupru, cu filet exterior și capăt drept

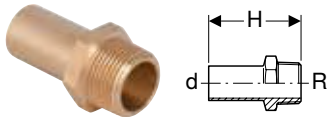

click & scan
EUR/buc.

Cod art.	DN	d, ø [mm]	R ["]	H [cm]	
61932	12 / 15	15	1/2"	5,7	7,06
61933	15	18	1/2"	5,7	8,26
61935	20 / 15	22	1/2"	5,7	8,92
61936	20	22	3/4"	5,9	8,92

Adaptor Geberit Mapress Cupru, cu filet interior

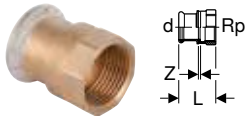

click & scan
EUR/buc.

Cod art.	DN	d, ø [mm]	Rp ["]	L [cm]	Z [cm]	
61845	10	12	3/8"	3,1	0,4	3,68
61801	10 / 15	12	1/2"	3,5	0,5	4,10
61846	12 / 10	15	3/8"	3,3	0,3	4,60
61802	12 / 15	15	1/2"	3,8	0,5	4,60
61823	12 / 20	15	3/4"	3,9	0,4	4,60
61803	15	18	1/2"	3,7	0,4	6,08
61804	15 / 20	18	3/4"	3,9	0,4	6,08
61805	20 / 15	22	1/2"	3,6	0,2	6,72
61806	20	22	3/4"	3,9	0,3	6,72
61824	20 / 25	22	1"	4,3	0,5	6,72
61819	25 / 20	28	3/4"	3,9	0,3	9,42
61809	25	28	1"	4,5	0,5	9,42
61825	25 / 32	28	1 1/4"	4,8	0,6	10,03
61820	32 / 25	35	1"	4,6	0,3	19,62
61811	32	35	1 1/4"	5	0,5	19,62
61821	40 / 32	42	1 1/4"	5,2	0,3	28,87
61814	40	42	1 1/2"	5,4	0,5	28,87
61818	50	54	2"	6,3	0,5	42,62

Adaptor Geberit Mapress Cupru, cu filet interior și capăt drept

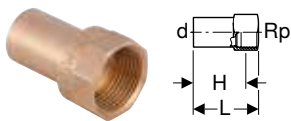

click & scan
EUR/buc.

Cod art.	DN	d, ø [mm]	Rp ["]	L [cm]	H [cm]	
63558	12 / 15	15	1/2"	4,6	3,3	11,17
63559	15	18	1/2"	4,6	3,3	11,68
63560	15 / 20	18	3/4"	4,8	3,3	11,68
63561	20 / 15	22	1/2"	4,6	3,3	12,18
63562	20	22	3/4"	4,9	3,4	12,18
63564	32 / 25	35	1"	6,3	4,6	22,92
63565	50	54	2"	8,5	6,2	50,33



Cot adaptor Geberit Mapress Cupru 90° cu filet exterior

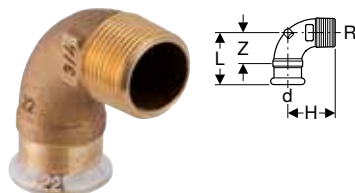

click & scan

Cod art.	DN	d, ø [mm]	R ["]	arc [°]	L [cm]	H [cm]	Z [cm]	EUR/buc.
63892	10	12	3/8"	90	3	2,5	1,3	18,35
63893	10 / 15	12	1/2"	90	3,2	3,1	1,5	18,35
63894	12 / 10	15	3/8"	90	3,2	2,7	1,2	21,37
63873	12 / 15	15	1/2"	90	3,5	3,1	1,5	13,36
63884	15	18	1/2"	90	3,5	3,4	1,5	16,74
63895	15 / 20	18	3/4"	90	3,8	3,3	1,8	22,94
63885	20	22	3/4"	90	4,8	4,4	2,7	21,54
63886	25	28	1"	90	5,8	5,3	3,5	29,42
63887	32	35	1 1/4"	90	5,5	4,7	2,9	45,06
63888	40	42	1 1/2"	90	6,2	5,1	3,2	73,47
63889	50	54	2"	90	7	6,3	3,5	93,68

Cot adaptor Geberit Mapress Cupru 90° cu filet interior

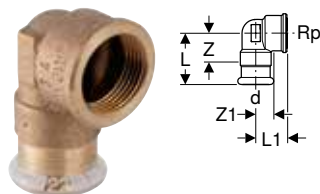

click & scan

Cod art.	DN	d, ø [mm]	Rp ["]	arc [°]	L [cm]	L1 [cm]	Z [cm]	Z1 [cm]	EUR/buc.
63860	10	12	3/8"	90	3,2	2,3	1,5	1,3	16,88
63861	10 / 15	12	1/2"	90	3,4	2,4	1,7	1,1	16,88
63862	12 / 10	15	3/8"	90	3,3	2,4	1,3	1,4	13,36
63853	12 / 15	15	1/2"	90	3,6	2,7	1,6	1,4	13,36
63854	15	18	1/2"	90	3,6	3	1,6	1,7	16,74
63863	15 / 20	18	3/4"	90	3,8	3,1	1,8	1,6	16,74
63864	20 / 15	22	1/2"	90	3,8	3,2	1,7	1,9	21,54
63855	20	22	3/4"	90	4,5	2,7	2,4	1,2	21,54
63856	25	28	1"	90	5,1	3,3	2,8	1,6	29,42
63857	32	35	1 1/4"	90	5,5	4,5	2,9	2,6	45,06
63865	40	42	1 1/2"	90	6,7	5,2	3,7	3,3	73,47
63866	50	54	2"	90	7,4	6	3,9	3,7	93,68

Adoptoare și conexiuni, cu posibilitate de desfacere

Adaptor cu filet Geberit Mapress Cupru, cu filet exterior

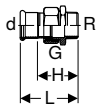

click & scan
EUR/buc.

Cod art.	DN	d, ø [mm]	R ["]	G ["]	L [cm]	H [cm]	EUR/buc.
65531	10	12	3/8"	1/2"	5,1	3,4	18,99
65540	10 / 15	12	1/2"	1/2"	5,5	3,8	18,99
65532	12 / 15	15	1/2"	3/4"	6,1	4,1	18,99
65541	12 / 20	15	3/4"	3/4"	6,3	4,3	18,99
65533	15	18	1/2"	3/4"	6,1	4,1	21,71
65542	15 / 20	18	3/4"	3/4"	6,3	4,3	21,71
65534	20 / 15	22	1/2"	1"	6,7	4,6	22,67
65543	20	22	3/4"	1"	6,8	4,7	22,67
65544	20 / 25	22	1"	1"	6,9	4,8	22,67
65535	25	28	1"	1 1/4"	7,5	5,2	33,37
65536	32	35	1 1/4"	1 1/2"	8	5,4	41,96
65537	40	42	1 1/2"	1 3/4"	8,5	5,5	52,36
65538	50	54	2"	2 3/8"	9,7	6,2	97,39

Adaptor cu filet Geberit Mapress Cupru, cu filet interior

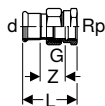

click & scan
EUR/buc.

Cod art.	DN	d, ø [mm]	Rp ["]	G ["]	L [cm]	Z [cm]	EUR/buc.
65481	10 / 15	12	1/2"	1/2"	5,2	2,2	18,99
65482	12 / 15	15	1/2"	3/4"	5	1,7	18,99
65490	12 / 20	15	3/4"	3/4"	5,9	2,4	18,99
65483	15	18	1/2"	3/4"	5	1,7	21,71
65491	15 / 20	18	3/4"	3/4"	5,9	2,4	21,71
65484	20	22	3/4"	1"	6,2	2,6	22,67
65492	20 / 25	22	1"	1"	6,6	2,8	22,67
65485	25	28	1"	1 1/4"	6,3	2,3	33,37
65486	32	35	1 1/4"	1 1/2"	7,5	3	41,96
65487	40	42	1 1/2"	1 3/4"	7,9	3	52,36
65488	50	54	2"	2 3/8"	8,5	2,7	97,39

Adaptor cu filet de colț Geberit Mapress Cupru 90° cu filet interior

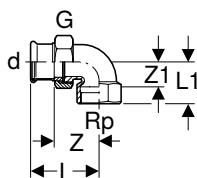

click & scan

Cod art.	DN	d, ø [mm]	Rp ["]	G ["]	arc [°]	L [cm]	L1 [cm]	Z [cm]	Z1 [cm]	EUR/buc.
65382	12 / 15	15	1/2"	3/4"	90	5,7	3,2	3,7	1,9	27,59
65392	15	18	1/2"	3/4"	90	5,7	3,2	3,7	1,9	28,73
65384	20	22	3/4"	1"	90	6,4	3,6	4,3	2,1	38,66
65385	25	28	1"	1 1/4"	90	7,2	4,4	4,9	2,7	43,81
65386	32	35	1 1/4"	1 1/2"	90	8	5	5,4	3,1	56,01
65387	40	42	1 1/2"	1 3/4"	90	8,7	5,3	5,7	3,4	78,95
65388	50	54	2"	2 3/8"	90	10,1	6,4	6,6	4,1	108,71

Geberit Mapress Cupru

Geberit Mapress Cupru

Adaptoare și conexiuni, cu posibilitate de desfacere

Adaptor Geberit Mapress Cupru, cu piuliță

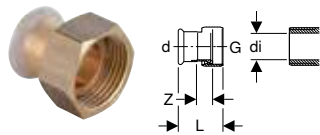

click & scan

Cod art.	DN	d, ø [mm]	G ["]	di, ø [mm]	L [cm]	Z [cm]	EUR/buc.
65081	10	12	1/2"	10	3,2	0,9	7,11
65182	12	15	1/2"	10	5,1	2,5	8,61
65082	12	15	3/4"	13	3,7	1,1	7,11
65083	15	18	3/4"	13	3,7	1,1	7,50
65040	15	18	1"	20	3,9	1,3	10,71
65084	20	22	1"	20	4	1,1	11,91
65044	20	22	1 1/4"	26	4,3	1,3	11,91
65045	20	22	1 1/2"	32	4,4	1,3	11,91
65046	25	28	1"	20	5,5	1,3	14,38
65085	25	28	1 1/4"	26	4,4	1,3	14,38
65050	25	28	1 1/2"	32	4,6	1,3	14,38
65086	32	35	1 1/2"	32	4,8	1,3	13,53
65051	32	35	2"	42	4,8	1,2	21,61
65087	40	42	1 3/4"	39	5,2	1,3	25,70
65052	40	42	2"	42	5,4	1,4	25,70
65053	40	42	2 1/4"	42	5,6	1,4	25,70
65088	50	54	2 3/8"	51	5,8	1,5	36,52
65054	50	54	2 1/2"	54	6,3	1,4	42,68
65090	65	76,1	3"	73	9,1	2,5	219,52
65091	80	88,9	3 1/2"	84	9,8	2,4	289,96

Adaptor Geberit Mapress cu îmbinare filetată inelară de fixare pentru tuburi ondulate, apă nepotabilă, capăt drept

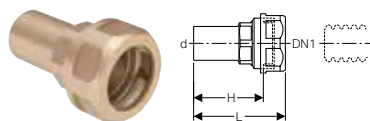

click & scan

Cod art.	DN	DN1	d, ø [mm]	L [cm]	H [cm]	PN [bar]	EUR/buc.
22421	12	16	15	6,4	4,9	10	16,93
22431	12	20	15	6,7	5,2	10	19,77
22422	15	16	18	6,4	4,9	10	18,35
22432	15	20	18	6,7	5,2	10	21,23
22423	20	16	22	6,8	5,9	10	19,77
22433	20	20	22	6,8	5,9	10	22,60
22444	25	25	28	6,8	5,9	10	31,05



- În cazul unor presiuni de exploatare diferite pentru îmbinarea filetată și țeava ondulantă trebuie luată în considerație presiunea de exploatare mai mică.

Colier Geberit Mapress Cupru cu capăt drept, pentru flanșă liberă PN 10/16

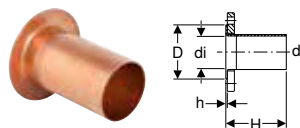

click & scan

Cod art.	DN	d, ø [mm]	di, ø [mm]	D [cm]	H [cm]	h [cm]	PN [bar]	EUR/buc.
63706	25	28	25,2	6,8	8,1	0,2	10 / 16	89,83
63707	32	35	32	7,8	9,3	0,2	10 / 16	102,92
63708	40	42	39	8,8	10,9	0,2	10 / 16	116,17
63709	50	54	51	10,2	10,9	0,2	10 / 16	144,08
63711	65	76,1	72,1	12,2	14,5	0,2	10 / 16	192,08
63712	80	88,9	84,9	13,8	15,2	0,2	10 / 16	224,75
63713	100	108	104	15,8	17,4	0,3	10 / 16	279,37

De comandat suplimentar

- Flanșă liberă Geberit Mapress PN 10/16 → p. 251

Accesorii

- Garnitură flanșă Geberit PN 10/16, din fibre compozite → p. 157

Flanșă liberă Geberit Mapress PN 10/16



click & scan

Cod art.	DN	di, ø [mm]	D [cm]	k [mm]	m [mm]	H [cm]	n [pc.]	PN [bar]	EUR/buc.
23715	25	31	11,5	85	14	1,6	4	10 / 16	44,99
23716	32	39	14	100	18	1,6	4	10 / 16	51,22
23717	40	47	15	115	18	1,6	4	10 / 16	56,26
23718	50	59	16,5	125	18	1,6	4	10 / 16	61,60
23719	65	82	18,5	145	18	1,6	4	10 / 16	71,82
23720	80	96	20	160	18	1,8	8	10 / 16	89,15
23721	100	119	22	180	18	1,8	8	10 / 16	117,80

Accesorii

- Set șurub Geberit pentru conexiune cu flanșă, din oțel galvanizat → p. 158

Dispozitive de închidere

Capac Geberit Mapress Cupru

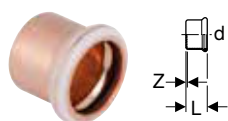

click & scan

Cod art.	DN	d, ø [mm]	L [cm]	Z [cm]	EUR/buc.
60231	10	12	2	0,3	4,60
60232	12	15	2,3	0,3	4,90
60233	15	18	2,3	0,3	6,08
60234	20	22	2,5	0,4	8,13
60235	25	28	2,7	0,4	12,56
60236	32	35	3	0,4	14,04
60237	40	42	3,4	0,4	21,71
60238	50	54	3,9	0,4	28,18
60240	65	76,1	6,4	1,1	74,06
60241	80	88,9	7,1	1,1	89,97
60242	100	108	8,6	1,1	122,81

Racorduri

Cot de racordare Geberit Mapress Cupru 90°

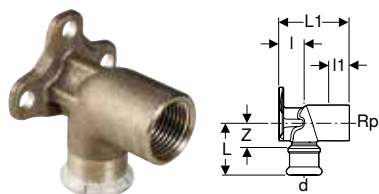

click & scan

Cod art.	DN	d, ø [mm]	Rp ["]	arc [°]	L [cm]	I [cm]	I1 [cm]	Z [cm]	EUR/buc.
L1 / lungime: 3,6 cm									
63458	10 / 15	12	1/2"	90	3,4	1,8	1,8	1,7	22,36
63459	12 / 15	15	1/2"	90	3,8	1,8	1,8	1,8	14,74
63460	15	18	1/2"	90	3,8	1,8	1,8	1,8	22,36
L1 / lungime: 5,2 cm									
63452	10 / 15	12	1/2"	90	3,4	1,8	3,4	1,7	22,36
63453	12 / 15	15	1/2"	90	3,4	1,8	3,4	1,4	14,74
63455	15	18	1/2"	90	3,4	1,8	3,4	1,4	22,31
63457	20	22	3/4"	90	3,7	2,2	3	1,6	24,61

Cot de racordare dublu Geberit Mapress Cupru 90°

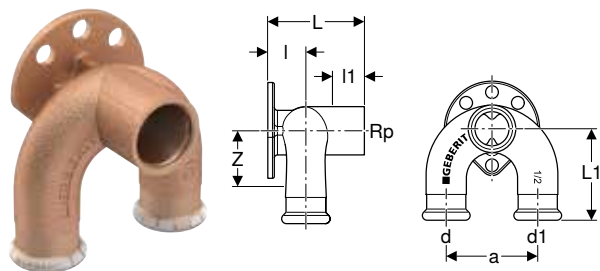

click & scan

Cod art.	DN	d, ø [mm]	Rp ["]	d1, ø [mm]	arc [°]	a [cm]	L1 [cm]	I [cm]	I1 [cm]	Z [cm]	EUR/buc.
L / lungime: 5,2 cm											
63462	12	15	1/2"	15	90	5	5	1,8	2,4	3	47,31
63463	15	18	1/2"	18	90	5	5	2	2,4	3	51,77
63464	20	22	1/2"	22	90	5	5	1,8	2,4	2,9	57,68

Colțar de racordare Geberit Mapress Cupru 90°

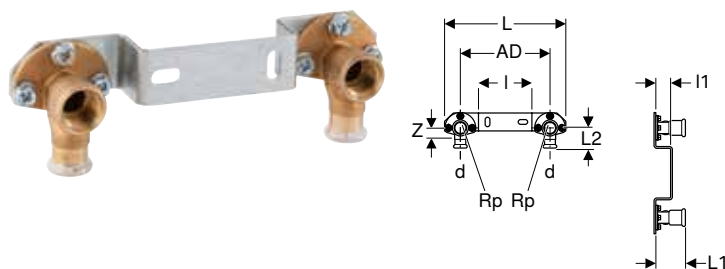

click & scan

Cod art.	DN	d, ø [mm]	Rp ["]	arc [°]	AD [cm]	L [cm]	L2 [cm]	I [cm]	I1 [cm]	Z [cm]	EUR/buc.
L1 / lungime: 3,6 cm											
63473	12	15	1/2"	90	15,3	20,5	3,8	9	1,8	1,8	50,33

Teuri pentru instalații de încălzire

Teu cruce Geberit Mapress, cu cutie izolatoare

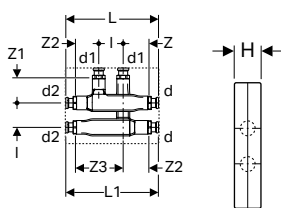

click & scan

Cod art.	DN	d, ø [mm]	d1, ø [mm]	d2, ø [mm]	arc [°]	L [cm]	L1 [cm]	I [cm]	H [cm]	Z [cm]	Z1 [cm]	Z2 [cm]	Z3 [cm]	EUR/buc.
63113	12 / 12 / 12	15	15	15	90	19	19	5	5	4,8	5,2	5,3	9,8	71,10
63115	15 / 12 / 15	18	15	18	90	19	19	5	5	4,8	5,2	5,3	9,8	78,58
63125	15 / 15 / 15	18	18	18	90	19	19	5	5	4,8	5,2	5,3	9,8	78,58
63117	20 / 12 / 20	22	15	22	90	19,2	19,2	5	5	4,8	5,2	5,3	9,8	82,32
63118	20 / 15 / 20	22	18	22	90	19,2	19,2	5	5	4,8	5,2	5,3	9,8	82,32

Racorduri pentru instalații de încălzire

Set teu racordare Geberit Mapress Cupru pentru retur

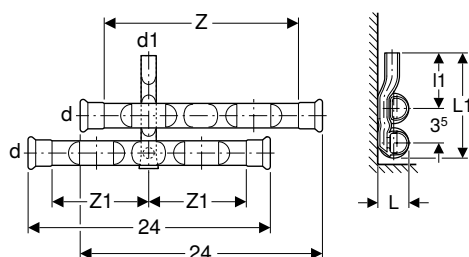
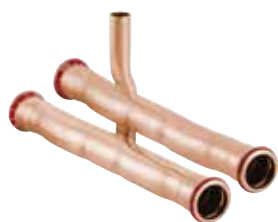

click & scan

Cod art.	DN	d, ø [mm]	d1, ø [mm]	arc [°]	L [cm]	L1 [cm]	I1 [cm]	Z [cm]	Z1 [cm]	EUR/buc.
23615	12	15	15	90	2,7	10,8	6,5	20	10	32,99
23616	15 / 12	18	15	90	2,9	11	6,5	20	10	34,12
23617	20 / 12	22	15	90	3,3	11,2	6,5	20	10	35,19

Set teuri racordare Geberit Mapress Cupru pentru tur și retur

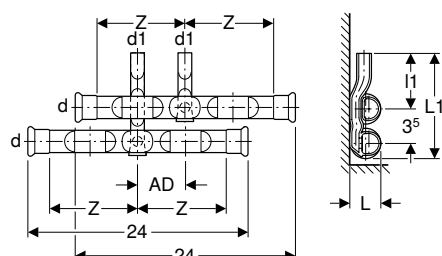

click & scan

Cod art.	DN	d, ø [mm]	d1, ø [mm]	arc [°]	AD [cm]	L [cm]	L1 [cm]	I1 [cm]	Z [cm]	EUR/buc.
24005	12	15	15	90	4-6	2,7	10,8	6,5	10	54,28
24006	15 / 12	18	15	90	4-6	2,9	11	6,5	10	56,21
24007	20 / 12	22	15	90	4-6	3,3	11,2	6,5	10	59,13

Set teuri racordare Geberit Mapress Cupru pentru tur și retur, cu îmbinare filetată de racordare pentru eurocon

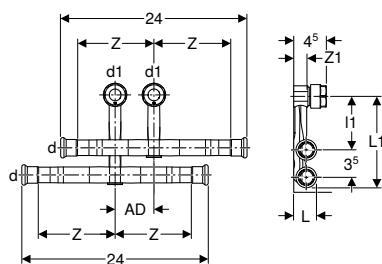

click & scan

Cod art.	DN	d, ø [mm]	d1, ø [mm]	arc [°]	AD [cm]	L [cm]	L1 [cm]	l1 [cm]	Z [cm]	Z1 [cm]	EUR/buc.
24055	12	15	15	90	5	2,7	12,6	6,8	10	1,7	59,81
24056	15 / 12	18	15	90	5	2,9	12,7	6,8	10	1,7	61,58
24057	20 / 12	22	15	90	5	3,3	13	6,8	9,9	1,7	64,28



- Îmbinarea filetată se strânge până la limită

Îmbinare filetată de racord Geberit pentru eurocon

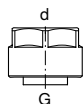

click & scan

Cod art.	DN	d, ø [mm]	G ["]	EUR/buc.
25073	12 / 20	15	3/4"	3,96



- Îmbinarea filetată se strânge până la limită

Accesorii pentru Geberit Mapress Cupru

Izolații pentru racorduri

Set fonoizolant Geberit pentru cot de conectare 90° simplu

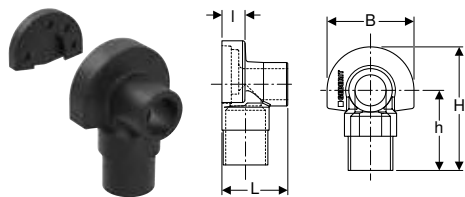

click & scan

Cod art.	L [cm]	I [cm]	B [cm]	H [cm]	h [cm]	EUR/buc.
601.801.00.1	5,3	1,9	7	10	6,5	3,03

Suport fonoizolant Geberit pentru conectare drept



click & scan

Cod art.	EUR/buc.
601.802.00.1	1,36

Etanșări pentru țevi și fittinguri

Bandă de etanșare Geberit

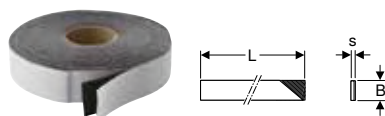

click & scan

Cod art.	S [mm]	L [m]	B [cm]	EUR/buc.
601.813.00.1	1	12,5	3	31,41
601.815.00.1	1	12,5	5	52,06



- Montare după încercare la presiune



Dispozitive de fixare pentru țevi

Brățară pentru conductă Geberit, izolată, cu piuliță conector M8 / M10

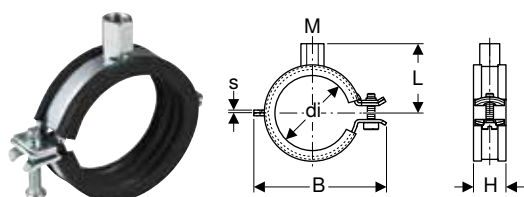

click & scan

Cod art.	Culoare/suprafață	M [mm]	di, \varnothing [mm]	L [cm]	B [cm]	H [cm]	EUR/buc.
601.851.26.1	Galvanizat	8 / 10	15-19	3,1	5,2	2,3	1,75
601.852.26.1	Galvanizat	8 / 10	20-24	3,4	5,6	2,3	1,75
601.853.26.1	Galvanizat	8 / 10	25-30	3,6	6,3	2,3	1,86
601.854.26.1	Galvanizat	8 / 10	32-37	3,9	6,8	2,3	2,00
601.855.26.1	Galvanizat	8 / 10	40-46	4,3	7,6	2,3	2,12
601.857.26.1	Galvanizat	8 / 10	54-58	4,8	8,9	2,3	2,61
601.858.26.1	Galvanizat	8 / 10	63-67	5,5	10	2,3	3,34
601.859.26.1	Galvanizat	8 / 10	74-80	6,4	11,9	2,3	3,61
601.860.26.1	Galvanizat	8 / 10	83-91	6,8	13	2,3	3,74
601.861.26.1	Galvanizat	8 / 10	108-114	8,1	15,3	2,8	4,23

Niplu dublu Geberit M10 / G 1/2"

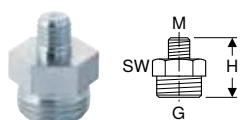

click & scan

Cod art.	Culoare/suprafață	G ["]	M [mm]	H [cm]	SW [mm]	EUR/buc.
362.856.26.1	Galvanizat	1/2"	10	2,8	22	5,60

Tijă filetată Geberit

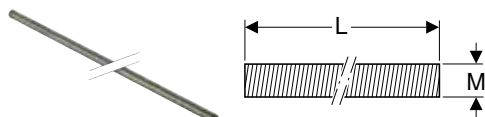

click & scan

Cod art.	Culoare/suprafață	M [mm]	L [cm]	EUR/buc.
362.834.26.1	Galvanizat	10	200	6,83

Țeavă filetată Geberit

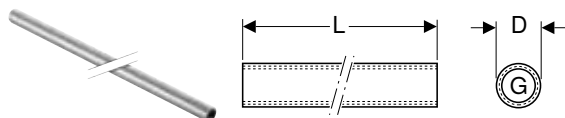

click & scan

Cod art.	G ["]	D [cm]	L [cm]	EUR/buc.
362.857.26.1	1/2"	2,5	115	38,24

Placă de fixare Geberit dreptunghiulară, două orificii, cu piuliță conector M8/M10

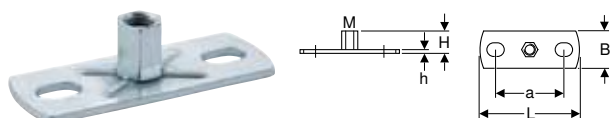

click & scan

Cod art.	M [mm]	a [cm]	L [cm]	B [cm]	H [cm]	h [cm]	EUR/buc.
362.848.26.1	8 / 10	5,4	8	3	1,9	0,3	3,81

Placă de fixare Geberit dreptunghiulară, două orificii, cu piuliță conector M10/G 1/2"

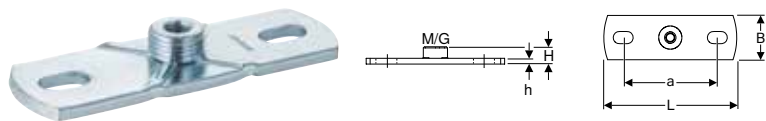

click & scan
 EUR/buc.

Cod art.	G ["]	M [mm]	a [cm]	L [cm]	B [cm]	H [cm]	h [cm]	EUR/buc.
362.851.26.1	1/2"	10	8,5	12	4	1,5	0,5	4,68

Dispozitive de fixare pentru racorduri

Placă de montaj Geberit, dreaptă, simplă

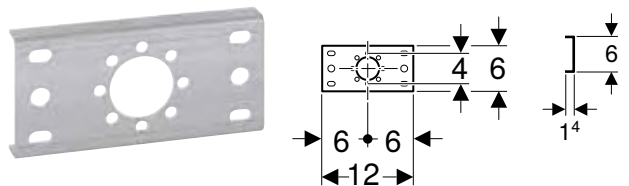

click & scan

Cod art.	EUR/buc.
601.736.00.1	5,69

Placă de montaj Geberit, dreaptă, dublă, distanță de racordare 10 cm sau 12 cm



click & scan

Cod art.	AD [cm]	AD1 [cm]	EUR/buc.
601.738.00.1	12	10	7,17

Accesorii

- Brățară pentru conductă de evacuare Geberit pentru plăci de montaj → p. 156

Placă de montaj Geberit, dreaptă, dublă, distanță de racordare 7,3 cm sau 15,3 cm

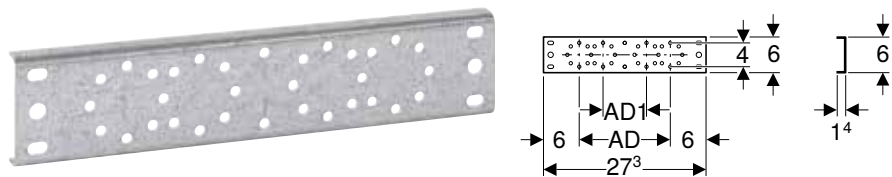

click & scan

Cod art.	AD [cm]	AD1 [cm]	EUR/buc.
601.737.00.1	15,3	7,3	7,17

Accesorii

- Brățară pentru conductă de evacuare Geberit pentru plăci de montaj → p. 156



Placă de montaj Geberit, cu decalaj, simplă, pentru sistemul de alimentare



click & scan

Cod art.
601.733.00.1

EUR/buc.
5,69

Placă de montaj Geberit, montată, dublă, distanță de racordare 10 cm sau 12 cm



click & scan

Cod art.
601.731.00.1

AD
[cm]
12

AD1
[cm]
10

EUR/buc.
7,17

Accesorii

- Brățară pentru conductă de evacuare Geberit pentru plăci de montaj → p. 156

Placă de montaj Geberit, montată, dublă, distanță de racordare 7,3 cm sau 15,3 cm

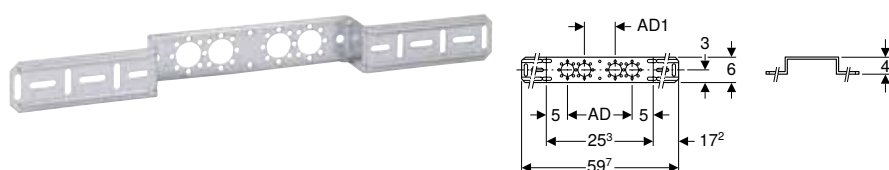

click & scan

Cod art.
601.732.00.1

AD
[cm]
15,3

AD1
[cm]
7,3

EUR/buc.
7,17

Accesorii

- Brățară pentru conductă de evacuare Geberit pentru plăci de montaj → p. 156

Brățară pentru conductă de evacuare Geberit pentru plăci de montaj

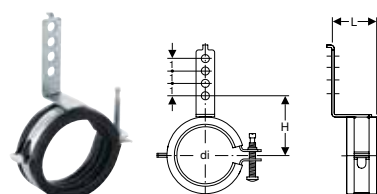

click & scan

Cod art.
601.741.00.1

Culoare/suprafață
Galvanizat

di, ø
[mm]
50-56

L
[cm]
3,6

H
[cm]
5,2-5,5

EUR/buc.
5,56

Garnituri de sistem

O-ring Geberit Mapress CIIR negru



click & scan

Cod art.	DN	d, ø [mm]	EUR/buc.
90401	10	12	0,34
90402	12	15	0,36
90403	15	18	0,47
90404	20	22	0,47
90405	25	28	0,55
90406	32	35	0,55
90407	40	42	0,84
90408	50	54	0,84

O-ring Geberit Mapress FKM albastru



click & scan

Cod art.	DN	d, ø [mm]	EUR/buc.
90881	10	12	2,43
90882	12	15	1,02
90883	15	18	1,24
90884	20	22	1,55
90885	25	28	1,84
90886	32	35	2,14
90887	40	42	3,82
90888	50	54	5,38

Garnitură plată Geberit Mapress EPDM neagră

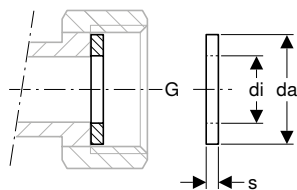

click & scan

Cod art.	G ["]	da [mm]	di, ø [mm]	s [mm]	EUR/buc.
90081	3/4"	24	13	2	1,92
90082	1"	30	19,6	2	1,92
90083	1 1/4"	39	25,6	2	1,92
90084	1 1/2"	45	32	2	1,92
90085	1 3/4"	50	39	2	1,92
90086	2 3/8"	66	51	3	1,92
90088	N 3"	84,7	76	3	2,40
90089	N 3 1/2"	97	84	3	2,89

N: Nou, livrabil din April 2024



Garnitură plată Geberit Mapress FPM verde

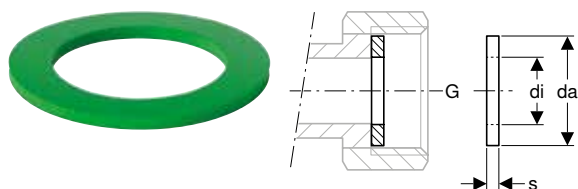

click & scan

Cod art.	G ["]	da [mm]	di, ø [mm]	s [mm]	EUR/buc.
90092	3/4"	24	13	2	2,01
90094	1"	30	19,6	2	3,03
90095	1 1/4"	39	25,6	2	3,03
90096	1 1/2"	45	32	2	3,96
90097	1 3/4"	50	39	2	3,96
90098	2 3/8"	66	51	2	10,35

Nou

Garnitură plată Geberit Mapress, din fibre compozite



click & scan

EUR/buc.

Cod art.	G ["]	da [mm]	di, ø [mm]	s [mm]	EUR/buc.
600.079.00.1	1/2"	18,4	10	2	1,11
600.080.00.1	3/4"	23,9	13	2	1,34
600.081.00.1	1"	30	19,6	2	1,47
600.082.00.1	1 1/8"	34,7	21	2	1,56
600.083.00.1	1 1/4"	38	25	2	1,78
600.084.00.1	1 1/4"	38,7	25,6	2	1,78
600.085.00.1	1 1/2"	44,6	32	2	1,93
600.087.00.1	1 3/4"	50,5	39	2	2,11
600.088.00.1	2"	56,4	42	2	2,22
600.089.00.1	2 1/4"	62,5	42	2	2,33
600.090.00.1	2 3/8"	66,2	51	2	2,67
600.091.00.1	2 1/2"	72	54	2	3,00
600.092.00.1	2 3/4"	78,3	57	2	3,33
600.093.00.1	3"	84,7	72,1	2	3,66
600.094.00.1	3 1/2"	97,1	84,9	2	4,00

Livrabil din April 2024



- Produs înlocuitor pentru cod art. 90072, 90074, 90075, 90076, 90077, 90078

Nou

Garnitură flanșă Geberit PN 6, din fibre compozite



click & scan
EUR/buc.

Cod art.	DN	da [mm]	di, ø [mm]	s [mm]	PN [bar]	
600.051.00.1	15	44	20	2	6	1,67
600.052.00.1	20	54	25	2	6	1,87
600.053.00.1	25	64	30	2	6	2,22
600.054.00.1	32	76	38	2	6	2,64
600.055.00.1	40	86	45	2	6	3,15
600.056.00.1	50	96	57	2	6	3,73
600.057.00.1	65	116	76	2	6	4,68
600.058.00.1	80	132	89	2	6	5,61
600.059.00.1	100	152	108	2	6	6,72

Livrabil din April 2024



- Produs înlocuitor pentru cod art. 91041, 91042, 91043, 91044, 91045, 91046, 91047, 91048, 91049

Nou

Garnitură flanșă Geberit PN 10/16, din fibre compozite



click & scan
EUR/buc.

Cod art.	DN	da [mm]	di, ø [mm]	s [mm]	PN [bar]	
600.041.00.1	15	50	20	2	10 / 16	1,89
600.042.00.1	20	60	25	2	10 / 16	2,11
600.043.00.1	25	70	30	2	10 / 16	2,51
600.044.00.1	32	82	38	2	10 / 16	2,98
600.045.00.1	40	92	45	2	10 / 16	3,55
600.046.00.1	50	107	57	2	10 / 16	4,22
600.047.00.1	65	127	76	2	10 / 16	5,28
600.048.00.1	80	142	89	2	10 / 16	6,34
600.049.00.1	100	162	108	2	10 / 16	7,61

Livrabil din April 2024



- Produs înlocuitor pentru cod art. 91031, 91032, 91033, 91034, 91035, 91036, 91037, 91038, 91039



Seturi de șuruburi pentru conexiuni cu flanșă

Set șurub Geberit pentru conexiune cu flanșă, din oțel CrNi

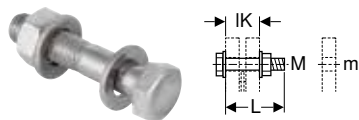

click & scan
EUR/buc.

Cod art.	M [mm]	m [mm]	L [cm]	IK [cm]	
91164	10	11	4,5	3,1	4,80
91165	10	11	5	3,6	4,80
91166	12	14	5	3	6,32
91167	12	14	5,5	3,5	6,32
91168	12	14	6	4	6,32
91169	16	18	5,5	3,3	9,45
91170	16	18	6	3,8	9,45
91171	16	18	6,5	4,3	9,45
91172	16	18	7	4,8	9,45
91173	16	18	8	5,8	9,45

Set șurub Geberit pentru conexiune cu flanșă, din oțel galvanizat

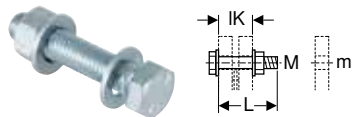

click & scan
EUR/buc.

Cod art.	M [mm]	m [mm]	L [cm]	IK [cm]	
91064	10	11	4,5	3,1	2,01
91065	10	11	5	3,6	2,01
91066	12	14	5	3	2,16
91067	12	14	5,5	3,5	2,16
91068	12	14	6	4	2,16
91069	16	18	5,5	3,3	3,93
91070	16	18	6	3,8	3,93
91071	16	18	6,5	4,3	3,93
91072	16	18	7	4,8	3,93
91073	16	18	8	5,8	3,93





Geberit Mapress CuNiFe

Modificări dimensionale Geberit Mapress CuNiFe aprilie 2023 - aprilie 2024	266
Vedere de ansamblu asupra utilizărilor – Geberit Mapress CuNiFe	267
Geberit Mapress CuNiFe.....	268
Țevi 2.1972	268
Mufe	268
Reducții	269
Coturi	270
Teuri	272
Adaptoare, fără posibilitate de desfacere	273
Adaptoare și conexiuni, cu posibilitate de desfacere	275
Treceri	276
Accesorii pentru Geberit Mapress CuNiFe	277
Garnituri de sistem	277
Seturi de șuruburi pentru conexiuni cu flanșă	280

Vedere de ansamblu asupra utilizărilor – Geberit Mapress CuNiFe

Geberit România, Versiune: December 2023

Domenii de utilizare	Temperatură de operare	Presiunea maximă de exploatare	Țevi	Fitinguri	Inele de etanșare		
			CuNiFe	Indicator negru CuNiFe	CIIR negru	FKM albastru	
Medii fluide							
Pentru apă de răcire și de încălzire fără antigel	0–100 °C	12 bar/1300 kPa	✓	✓	✓		
Pentru apă de răcire și de încălzire fără antigel	-30 – +120 °C	12 bar/1300 kPa	✓	✓	✓ ⁴⁾		
Pentru apa de operare și de proces	0–100 °C	12 bar/1300 kPa	3)	3)	3)		
Pentru ape gri și negre cu valoarea pH > 6.0	0–100 °C	12 bar/1300 kPa	✓	✓	✓		
Pentru apă de mare	0–100 °C	12 bar/1300 kPa	✓	✓	✓		
Pentru apă pentru stingerea incendiilor (umed)	0–70 °C	12 bar/1300 kPa	✓	✓	✓		
Pentru sprinklere (umed)	0–70 °C	12 bar/1300 kPa	✓	✓	✓		
Pentru uleiuri minerale și de lubrifiere	La cerere	La cerere	3)	3)			3)
Pentru combustibili (de ex. diesel)	La cerere	La cerere	3)	3)			3)
Medii gazoase							
Pentru aer comprimat (clasă de puritate ulei 0-3) ¹⁾	0–100 °C	10 bar /1000 kPa	✓	✓	✓		
Pentru aer comprimat (clasă de puritate ulei 0-X) ¹⁾	0–100 °C	10 bar /1000 kPa	✓	✓			✓
Pentru presiune negativă ²⁾	0–40 °C	Abs. ≥ 0,2 bar/20 kPa	✓	✓	✓		
Pentru gaze inerte (de ex. azot)	La cerere	La cerere	3)	3)	3)		

✓ Utilizare generală aprobată, dacă sunt îndeplinite condițiile suplimentare definite conform notelor de subsol

¹⁾ Clasă de puritate ulei conform ISO 8573-1:2010E; pentru detalii privind umiditatea și particulele, consultați informațiile tehnice "Sisteme de conducte Geberit pentru instalații de aer comprimat"

²⁾ Presiune negativă utilizabilă pentru sisteme de conducte Geberit:

Presiunea negativă utilizabilă rezultă din presiunea aerului la locul de instalare minus presiunea absolută de 200 mbar.

Exemplu: presiunea aerului 980 mbar - presiune absolută 200 mbar = presiune negativă utilizabilă pe sistemul de conducte 780 mbar

³⁾ Following Geberit approval

⁴⁾ Pot fi utilizate doar produse antigel aprobate



- Pentru fiecare aplicație se vor respecta condițiile de utilizare din autorizațiile de referință, norme și reglementări tehnice. Ele pot diferi de datele specificate

Modificări dimensionale Geberit Mapress CuNiFe aprilie 2023 - aprilie 2024

Geberit România, Versiune: December 2023

		[°]	DN	d, ø	L	L1	H
Cot adaptor Geberit Mapress CuNiFe 90° cu filet interior	67506	90 °	20	22 mm		8.4 cm	
	67507	90 °	20	22 mm		8.6 cm	
Cot adaptor Geberit Mapress CuNiFe 90° cu filet exterior	67516	90 °	20	22 mm			8.2 cm
	67517	90 °	20	22 mm			8.6 cm



- Între aprilie 2023 și aprilie 2024, dimensiunile articolelor de mai sus se vor modifica conform tabel. Aceste articole cu noile dimensiuni vor avea un X suplimentar pe etichetă.

	Garnituri plate pentru îmbinări filetate			Garnituri de flanșă
	EPDM negru	FPM verde	Fibre compozite	Fibre compozite
	✓		✓	✓
			✓	✓
	3)		3)	3)
	✓		✓	✓
	✓		✓	✓
	✓		✓	✓
	✓		✓	✓
		3)	3)	3)
		3)	3)	3)
			✓	✓
		✓	✓	✓
	✓		✓	✓
	3)		3)	3)

Geberit Mapress CuNiFe

Țevi 2.1972

Țeavă Geberit Mapress CuNiFe

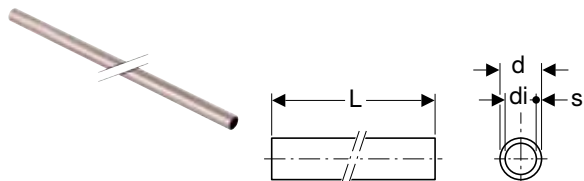

click & scan

Cod art.	DN	d, ø [mm]	di, ø [mm]	s [mm]	L [cm]	L [m]	EUR/m
56319	12	15	13	1	600	6	23,52
56321	20	22	20	1	600	6	29,63
56326	20	22	19	1,5	600	6	48,22
56322	25	28	25	1,5	600	6	58,79
56323	32	35	32	1,5	600	6	86,28
56324	40	42	39	1,5	600	6	106,30
56325	50	54	51	1,5	600	6	127,95
56327	65	76,1	72,1	2	600	6	260,94
56328	80	88,9	84,9	2	600	6	305,99
56329	100	108	104	2,5	600	6	386,98

Accesorii

- Aparat de tăiat țevi Geberit Mapress R → p. 324
- Aparat de debavurat țevi Geberit Mapress → p. 324
- Șablon de adâncime Geberit Mapress, cu știft de marcare → p. 325
- Debavurator electric de țevi Geberit RE 1 Mapress, în trusă → p. 324

Mufe

Mufă Geberit Mapress CuNiFe



click & scan

Cod art.	DN	d, ø [mm]	L [cm]	Z [cm]	EUR/buc.
67002	12	15	4,8	0,8	9,18
67004	20	22	5	0,8	11,47
67005	25	28	5,4	0,8	12,94
67006	32	35	6,2	1	16,01
67007	40	42	7,1	1,1	21,78
67008	50	54	8,3	1,3	26,13
67009	65	76,1	12,7	2,1	126,07
67010	80	88,9	14,5	2,5	147,00
67011	100	108	17,6	2,6	188,98

Mufă de inserție Geberit Mapress CuNiFe

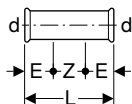

click & scan
EUR/buc.

Cod art.	DN	d, \emptyset [mm]	E [cm]	L [cm]	Z [cm]	
67102	12	15	2,5	8	3	15,16
67104	20	22	2,5	8,4	3,4	17,91
67105	25	28	3	9,1	3,1	20,87
67106	32	35	3	10,2	4,2	23,17
67107	40	42	4	12	4	26,91
67108	50	54	4	14	6	34,92
67109	65	76,1	6	23	11	191,06
67110	80	88,9	7	26	12	216,34
67111	100	108	8	31	15	260,45

Reducții

Reducție Geberit Mapress CuNiFe, cu capăt drept

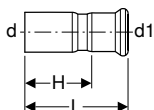

click & scan
EUR/buc.

Cod art.	DN	d, \emptyset [mm]	d1, \emptyset [mm]	L [cm]	H [cm]	
67305	20 / 12	22	15	5,9	3,9	11,68
67307	25 / 12	28	15	6,6	4,6	13,29
67309	25 / 20	28	22	6	3,9	13,29
67312	32 / 20	35	22	7,1	5	20,68
67313	32 / 25	35	28	6,8	4,5	20,68
67317	40 / 25	42	28	8,3	6	27,71
67318	40 / 32	42	35	7,6	5	27,71
67323	50 / 32	54	35	10,6	8	38,91
67324	50 / 40	54	42	8,9	5,9	38,91
67337	65 / 40	76,1	42	12,7	9,7	120,67
67325	65 / 50	76,1	54	14,6	11,1	120,67
67338	80 / 50	88,9	54	16,2	12,8	130,11
67327	80 / 65	88,9	76,1	16	10,7	130,11
67346	100 / 65	108	76,1	18,4	13,1	157,33
67330	100 / 80	108	88,9	20,4	14,4	137,04

Coturi

Cot Geberit Mapress CuNiFe

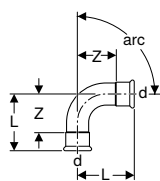

Cod art.	DN	d, ø [mm]	L [cm]	Z [cm]	EUR/buc.
arc / cot: 15°					
68716	12	15	3	1	14,74
68718	20	22	3,3	1,2	20,18
68719	25	28	3,6	1,3	24,96
68720	32	35	3,2	0,6	33,23
68721	40	42	3,7	0,7	52,71
68722	50	54	4,4	0,9	69,90
68723	65	76,1	7,5	2,2	206,19
68724	80	88,9	8,5	2,5	247,42
68725	100	108	10,3	2,8	367,33
arc / cot: 30°					
68736	12	15	3,3	1,3	14,74
68738	20	22	3,7	1,6	20,18
68739	25	28	4,1	1,8	24,96
68740	32	35	3,7	1,1	33,23
68741	40	42	4,4	1,4	52,71
68742	50	54	5,2	1,7	69,90
68743	65	76,1	8,8	3,5	206,19
68744	80	88,9	10,1	4,1	247,42
68745	100	108	12,2	4,7	367,33
arc / cot: 45°					
67602	12	15	2,8	0,8	14,46
67604	20	22	3,2	1,1	19,77
67605	25	28	3,7	1,4	24,96
67606	32	35	4,3	1,7	33,23
67607	40	42	5,1	2,1	52,71
67608	50	54	6,2	2,7	69,90
67609	65	76,1	10,3	5	206,19
67610	80	88,9	11,7	5,7	247,42
67611	100	108	14,3	6,8	367,33
arc / cot: 60°					
68804	12	15	4	2	14,74
68806	20	22	4,7	2,6	20,18
68807	25	28	5,4	3,1	25,47
68808	32	35	5	2,4	33,23
68809	40	42	5,9	2,9	52,71
68810	50	54	7,2	3,7	69,90
68811	65	76,1	11,7	6,4	206,19
68812	80	88,9	13,6	7,6	247,42
68813	100	108	16,6	9,1	367,33
arc / cot: 90°					
68102	12	15	2,8	0,8	14,46
68104	20	22	3,2	1,1	19,77
68105	25	28	5,7	3,4	24,96
68106	32	35	6,8	1,7	33,23
68107	40	42	8	2,1	52,71
68108	50	54	6,2	2,7	69,90
68109	65	76,1	15,9	10,6	206,19
68110	80	88,9	18,5	12,5	247,42
68111	100	108	23	15,5	367,33

Cot Geberit Mapress CuNiFe, cu capăt drept

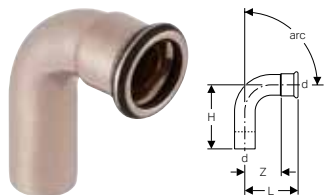

click & scan

Cod art.	DN	d, ø [mm]	L [cm]	H [cm]	Z [cm]	EUR/buc.
arc / cot: 45°						
67702	12	15	2,8	3,8	0,8	14,46
67704	20	22	3,2	4,4	1,1	19,77
67705	25	28	3,7	4,6	1,4	24,96
67706	32	35	5,3	4,3	1,7	33,23
67707	40	42	5,1	5,9	2,1	52,71
67708	50	54	6,2	7	2,7	69,90
67709	65	76,1	10,3	11,1	5	206,19
67710	80	88,9	11,7	12,8	5,7	247,42
67711	100	108	14,3	15,8	6,8	367,33
arc / cot: 90°						
68302	12	15	2,8	3,6	0,8	14,46
68304	20	22	3,2	3,9	1,1	19,77
68305	25	28	5,7	6,6	3,4	24,96
68306	32	35	6,8	7,7	4,2	33,23
68307	40	42	8	8,8	5	52,71
68308	50	54	6,2	7	2,7	69,90
68309	65	76,1	15,9	16,7	10,6	206,19
68310	80	88,9	18,5	19,5	12,5	247,42
68311	100	108	23	24,1	15,5	367,33

Cot de adaptare Geberit Mapress CuNiFe 90°

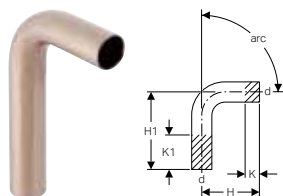

click & scan

Cod art.	DN	d, ø [mm]	arc [°]	H [cm]	H1 [cm]	K [cm]	K1 max. [cm]	EUR/buc.
67402	12	15	90	5,9	12,9	0	7	16,15
67404	20	22	90	7	14,2	0	7,2	16,96
67405	25	28	90	7,9	15,5	0	7,6	17,91
67406	32	35	90	7,7	15,4	0	7,7	36,95
67407	40	42	90	9	18	0	9	49,69
67408	50	54	90	11,1	20,5	0	9,4	68,20

Teuri

Teu Geberit Mapress CuNiFe, egal

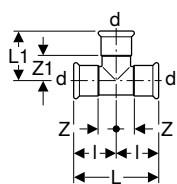

click & scan

Cod art.	DN	d, ø [mm]	arc [°]	L [cm]	L1 [cm]	I [cm]	Z [cm]	Z1 [cm]	EUR/buc.
68002	12	15	90	6,4	4	3,2	1,2	2	22,17
68004	20	22	90	7,4	4,5	3,7	1,6	2,4	25,18
68005	25	28	90	8,4	5,1	4,2	1,9	2,8	30,52
68006	32	35	90	10	5,9	5	2,4	3,3	38,03
68007	40	42	90	11,4	6,6	5,7	2,7	3,6	54,98
68008	50	54	90	13,8	7,2	6,9	3,4	3,7	63,69
68009	65	76,1	90	23	11	11,5	6,2	5,7	329,94
68010	80	88,9	90	26	12,7	13	7	6,7	343,59
68011	100	108	90	31	15,3	15,5	8	7,8	423,82

Teu Geberit Mapress CuNiFe, redus

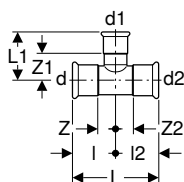

click & scan

Cod art.	DN	d, ø [mm]	d1, ø [mm]	d2, ø [mm]	arc [°]	L [cm]	L1 [cm]	I [cm]	I2 [cm]	Z [cm]	Z1 [cm]	Z2 [cm]	EUR/buc.
67206	20 / 12 / 20	22	15	22	90	7,4	4,4	3,7	3,7	1,6	2,4	1,6	25,18
67209	25 / 12 / 25	28	15	28	90	8,4	4,7	4,2	4,2	1,9	2,7	1,9	30,52
67211	25 / 20 / 25	28	22	28	90	8,4	4,8	4,2	4,2	1,9	2,7	1,9	30,52
67212	32 / 12 / 32	35	15	35	90	10	4,9	5	5	2,4	2,9	2,4	38,82
67214	32 / 20 / 32	35	22	35	90	10	5,2	5	5	2,4	2,1	2,4	38,03
67215	32 / 25 / 32	35	28	35	90	10	5,5	5	5	2,4	3,2	2,4	38,03
67218	40 / 20 / 40	42	22	42	90	11,4	5,4	5,7	5,7	2,7	3,3	2,7	54,98
67219	40 / 25 / 40	42	28	42	90	11,4	5,8	5,7	5,7	2,7	3,5	2,7	54,98
67220	40 / 32 / 40	42	35	42	90	11,4	6,2	5,7	5,7	2,7	3,6	2,7	54,98
67227	50 / 20 / 50	54	22	54	90	13,8	6,1	6,9	6,9	3,4	4	3,4	63,69
67228	50 / 25 / 50	54	28	54	90	13,8	6,4	6,9	6,9	3,4	4,1	3,4	63,69
67225	50 / 32 / 50	54	35	54	90	13,8	6,8	6,9	6,9	3,4	4,2	3,4	63,69
67226	50 / 40 / 50	54	42	54	90	13,8	7,2	6,9	6,9	3,4	4,2	3,4	63,69
67229	65 / 20 / 65	76,1	22	76,1	90	23	7,2	11,5	11,5	6,2	5,1	6,2	329,94
67230	65 / 25 / 65	76,1	28	76,1	90	23	7,5	11,5	11,5	6,2	5,2	6,2	329,94
67231	65 / 32 / 65	76,1	35	76,1	90	23	7,9	11,5	11,5	6,2	5,3	6,2	329,94
67252	65 / 40 / 65	76,1	42	76,1	90	23	8,3	11,5	11,5	6,2	5,3	6,2	329,94
67253	65 / 50 / 65	76,1	54	76,1	90	23	8,9	11,5	11,5	6,2	5,4	6,2	329,94
67233	80 / 20 / 80	88,9	22	88,9	90	26	7,8	13	13	7	5,7	7	343,59
67250	80 / 25 / 80	88,9	28	88,9	90	26	8,1	13	13	7	5,8	7	343,59
67251	80 / 32 / 80	88,9	35	88,9	90	26	8,5	13	13	7	5,9	7	343,59
67239	80 / 40 / 80	88,9	42	88,9	90	26	8,9	13	13	7	5,9	7	343,59
67260	80 / 50 / 80	88,9	54	88,9	90	26	9,5	13	13	7	6	7	343,59
67261	80 / 65 / 80	88,9	76,1	88,9	90	26	11,6	13	13	7	6,3	7	343,59
67244	100 / 20 / 100	108	22	108	90	31	8,8	15,5	15,5	8	6,7	8	423,82
67245	100 / 25 / 100	108	28	108	90	31	9,1	15,5	15,5	8	6,8	8	423,82
67246	100 / 32 / 100	108	35	108	90	31	9,5	15,5	15,5	8	6,9	8	423,82
67247	100 / 40 / 100	108	42	108	90	31	9,9	15,5	15,5	8	6,9	8	423,82
67248	100 / 50 / 100	108	54	108	90	31	10,5	15,5	15,5	8	7	8	423,82
67269	100 / 65 / 100	108	76,1	108	90	31	12,6	15,5	15,5	8	7,3	8	423,82
67270	100 / 80 / 100	108	88,9	108	90	31	13,7	15,5	15,5	8	7,7	8	423,82

Teu Geberit Mapress CuNiFe cu filet interior

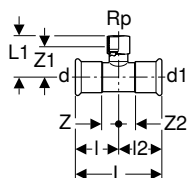

click & scan

Cod art.	DN	d, ø [mm]	Rp ["]	d1, ø [mm]	arc [°]	L [cm]	L1 [cm]	I [cm]	I2 [cm]	Z [cm]	Z1 [cm]	Z2 [cm]	EUR/buc.
67344	12 / 15 / 12	15	1/2"	15	90	6,4	3,7	3,2	3,2	0,8	2,4	0,8	25,18
67347	20 / 15 / 20	22	1/2"	22	90	7,4	4,1	3,7	3,7	1,6	2,8	1,6	34,64
67348	20	22	3/4"	22	90	7,4	4,6	3,7	3,7	1,6	3,1	1,6	34,64
67349	25 / 15 / 25	28	1/2"	28	90	8,4	4,4	4,2	4,2	1,9	3,1	1,9	38,75
67350	25 / 20 / 25	28	3/4"	28	90	8,4	4,6	4,2	4,2	1,9	3,1	1,9	38,75
67352	32 / 15 / 32	35	1/2"	35	90	10	4,8	5	5	2,4	3,5	2,4	46,97
67353	32 / 20 / 32	35	3/4"	35	90	10	5,3	5	5	2,4	4	2,4	46,97
67356	40 / 15 / 40	42	1/2"	42	90	11,4	5,1	5,7	5,7	2,7	3,8	2,7	57,32
67357	40 / 20 / 40	42	3/4"	42	90	11,4	5,6	5,7	5,7	2,7	4,3	2,7	57,32
67360	50 / 15 / 50	54	1/2"	54	90	13,8	5,7	6,9	6,9	3,4	4,4	3,4	68,54
67361	50 / 20 / 50	54	3/4"	54	90	13,8	6,2	6,9	6,9	3,4	4,9	3,4	68,54
67366	65 / 20 / 65	76,1	3/4"	76,1	90	23	7	11,5	11,5	6,2	5,5	6,2	326,93
67369	80 / 20 / 80	88,9	3/4"	88,9	90	26	7,6	13	13	7	6,1	7	348,25
67373	100 / 20 / 100	108	3/4"	108	90	31	8,6	15,5	15,5	8	7,1	8	427,67

Adaptoare, fără posibilitate de desfacere

Adaptor Geberit Mapress CuNiFe, cu filet exterior

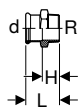

click & scan

EUR/buc.

Cod art.	DN	d, ø [mm]	R ["]	L [cm]	H [cm]	EUR/buc.
68703	12 / 15	15	1/2"	5,3	3,3	41,98
68715	20 / 15	22	1/2"	5,4	3,3	31,23
68707	20	22	3/4"	5,8	3,7	45,49
68708	25	28	1"	6,4	4,1	55,95
68709	32	35	1 1/4"	7,2	4,6	73,44
68710	40	42	1 1/2"	7,7	4,7	104,93
68711	50	54	2"	8,9	5,4	171,35



- Adaptoare cu filet NPT, la cerere

Adaptor Geberit Mapress CuNiFe, cu filet exterior, NPT

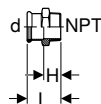

click & scan

EUR/buc.

Cod art.	DN	d, ø [mm]	NPT	L [cm]	H [cm]	EUR/buc.
68833	12 / 15	15	1/2"	6,1	4,1	33,73
68837	20	22	3/4"	6,3	4,2	44,99
68838	25	28	1"	7,2	4,9	62,44
68839	32	35	1 1/4"	7,8	5,2	101,11
68840	40	42	1 1/2"	8,3	5,3	135,84
68841	50	54	2"	9	5,5	201,93

Adaptor Geberit Mapress CuNiFe, cu filet interior



click & scan
EUR/buc.

Cod art.	DN	d, ø [mm]	Rp ["]	L [cm]	Z [cm]	EUR/buc.
67802	12 / 15	15	1/2"	5,5	2,2	27,57
67805	20 / 15	22	1/2"	5,6	2,2	31,23
67806	20	22	3/4"	5,8	2,2	31,23
67809	25	28	1"	6,4	2,4	55,95
67811	32	35	1 1/4"	7	2,5	72,68
67814	40	42	1 1/2"	7,4	2,5	93,40
67818	50	54	2"	8,9	3,1	113,84

Cot adaptor Geberit Mapress CuNiFe 90° cu filet exterior

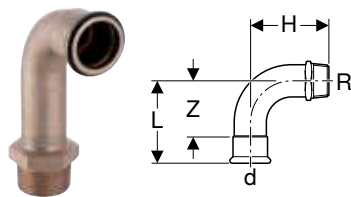

click & scan

Cod art.	DN	d, ø [mm]	R ["]	arc [°]	L [cm]	H [cm]	Z [cm]	EUR/buc.
67515	12 / 15	15	1/2"	90	3,8	7,5	1,8	33,23
67516	20 / 15	22	1/2"	90	4,7	8,4	2,6	43,62
67517	20	22	3/4"	90	4,7	8,8	2,6	43,62
67518	25	28	1"	90	5,7	9,7	3,4	50,69
67519	32	35	1 1/4"	90	6,8	11,2	4,2	73,42
67520	40	42	1 1/2"	90	8	12,4	5	116,85
67521	50	54	2"	90	10	14,4	6,5	148,91

Cot adaptor Geberit Mapress CuNiFe 90° cu filet interior

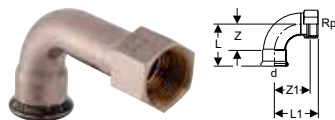

click & scan
EUR/buc.

Cod art.	DN	d, ø [mm]	Rp ["]	arc [°]	L [cm]	L1 [cm]	Z [cm]	Z1 [cm]	EUR/buc.
67503	12 / 15	15	1/2"	90	3,8	7,7	1,8	6,4	33,90
67506	20 / 15	22	1/2"	90	4,7	8,6	2,6	7,3	42,79
67507	20	22	3/4"	90	4,7	8,8	2,6	7,3	43,62
67508	25	28	1"	90	5,7	9,7	4	7,8	50,69
67509	32	35	1 1/4"	90	6,8	11	4,2	9,1	73,42
67510	40	42	1 1/2"	90	8	12,1	5	10,4	116,85
67511	50	54	2"	90	10	15	6,5	13	148,91

Accesorii

- Dispozitiv de fixare pentru cot adaptor Geberit Mapress 90° → p. 200

Adaptoare și conexiuni, cu posibilitate de desfacere

Adaptor cu filet Geberit Mapress CuNiFe, cu filet exterior

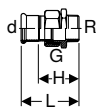

click & scan
EUR/buc.

Cod art.	DN	d, ø [mm]	R [°]	G [°]	L [cm]	H [cm]	EUR/buc.
67232	12 / 15	15	1/2"	3/4"	8,1	6,1	45,93
67234	20 / 15	22	1/2"	1"	8,4	6,3	58,02
67243	20	22	3/4"	1"	8,5	6,4	58,02
67235	25	28	1"	1 1/4"	9,6	7,3	82,13
67236	32	35	1 1/4"	1 1/2"	10,4	7,8	108,63
67237	40	42	1 1/2"	1 3/4"	10,9	7,9	140,44
67238	50	54	2"	2 3/8"	12,4	8,9	261,99

Flanșă Geberit Mapress CuNiFe PN 6, cu mufă de sertizare

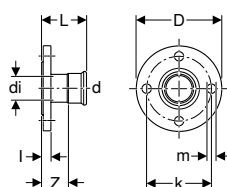

click & scan

Cod art.	DN	d, ø [mm]	di, ø [mm]	D [cm]	k [mm]	m [mm]	L [cm]	I [cm]	Z [cm]	n [pc.]	PN [bar]	EUR/buc.
68682	15 / 12	15	14,1	8	55	11	5,9	1	3,9	4	6	105,27
68684	20	22	19	9	65	11	6,3	1	4,2	4	6	129,52
68685	25	28	25,2	10	75	11	6,7	1	4,4	4	6	143,85
68686	32	35	32	12	90	14	6,8	1	4,2	4	6	178,31
68687	40	42	39	13	100	14	7,7	1,2	4,7	4	6	215,55
68688	50	54	51	14	110	14	8,5	1,4	5	4	6	297,20
68689	65	76,1	71,9	16	130	14	11,8	1,6	6,5	4	6	342,71
68690	80	88,9	84,7	19	150	18	12,3	1,6	6,3	4	6	552,79
68691	100	108	103,8	21	170	18	12,8	1,8	5,3	4	6	649,11

Accesorii

- Set șurub Geberit pentru conexiune cu flanșă, din oțel CrNi → p. 158
- Garnitură flanșă Geberit PN 6, din fibre compozite → p. 158

Flanșă Geberit Mapress CuNiFe PN 10/16, cu mufă de sertizare

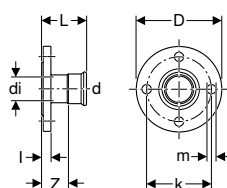

click & scan

Cod art.	DN	d, ø [mm]	di, ø [mm]	D [cm]	k [mm]	m [mm]	L [cm]	I [cm]	Z [cm]	n [pc.]	PN [bar]	EUR/buc.
68692	15 / 12	15	14,1	9,5	65	14	6,1	1,2	4,1	4	10 / 16	126,17
68694	20	22	19	10,5	75	14	6,5	1,2	4,4	4	10 / 16	157,92
68695	25	28	25,2	11,5	85	14	6,9	1,2	4,6	4	10 / 16	181,79
68696	32	35	32	14	100	18	7,2	1,4	4,6	4	10 / 16	293,73
68697	40	42	39	15	110	18	7,9	1,4	4,9	4	10 / 16	356,68
68698	50	54	51	16,5	125	18	8,7	1,6	5,2	4	10 / 16	437,12
68699	65	76,1	71,9	18,5	145	18	11,8	1,6	6,5	4	10 / 16	524,49
68700	80	88,9	84,7	20	160	18	12,5	1,8	6,5	8	10 / 16	576,93
68701	100	108	103,8	22	180	18	13	2	5,5	8	10 / 16	639,87

Accesorii

- Set șurub Geberit pentru conexiune cu flanșă, din oțel CrNi → p. 158
- Garnitură flanșă Geberit PN 10/16, din fibre compozite → p. 157

Colier Geberit Mapress CuNiFe cu capăt drept, pentru flanșă liberă PN 6

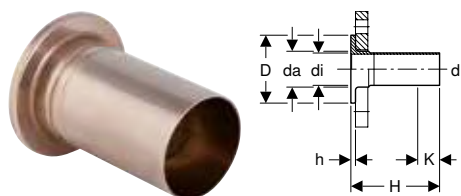

click & scan

Cod art.	DN	d, ø [mm]	da [mm]	di, ø [mm]	D [cm]	H [cm]	h [cm]	K [cm]	PN [bar]	EUR/buc.
68756	20	22	27	19	5	13,5	0,6	3,9	6	110,56
68757	25	28	32	25	6	13,5	0,6	3,7	6	139,09
68758	32	35	40	32	7	13,5	0,6	2,7	6	153,39
68759	40	42	47	39	8	13,5	0,6	0	6	185,49
68760	50	54	59	51	9	13,5	0,8	0	6	195,80
68761	65	76,1	78	72,1	11	13,5	0,8	0	6	356,68
68762	80	88,9	91	84,9	12,8	13,5	1	0	6	384,64
68763	100	108	110	104	14,8	13,5	1	0	6	454,59

De comandat suplimentar

- Flanșă liberă

Accesorii

- Garnitură flanșă Geberit PN 6, din fibre compozite → p. 158

Colier Geberit Mapress CuNiFe cu capăt drept, pentru flanșă liberă PN 10/16

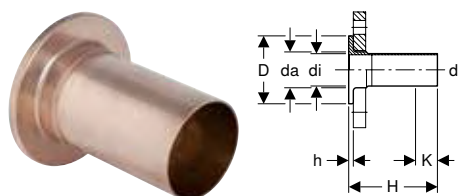

click & scan

Cod art.	DN	d, ø [mm]	da [mm]	di, ø [mm]	D [cm]	H [cm]	h [cm]	K [cm]	PN [bar]	EUR/buc.
68791	20	22	27	19	5,8	13,5	0,6	3,5	10 / 16	118,90
68793	25	28	32	25	6,8	13,5	0,6	3,7	10 / 16	146,84
68794	32	35	40	32	7,8	13,5	0,6	2,5	10 / 16	164,33
68795	40	42	47	39	8,8	13,5	0,6	0	10 / 16	213,32
68796	50	54	59	51	10,2	13,5	0,8	0	10 / 16	279,70
68797	65	76,1	78	72,1	12,2	13,5	0,8	0	10 / 16	367,16
68798	80	88,9	91	84,9	13,8	13,5	1	0	10 / 16	402,11
68799	100	108	110	104	15,8	13,5	1	0	10 / 16	466,25

De comandat suplimentar

- Flanșă liberă

Accesorii

- Garnitură flanșă Geberit PN 10/16, din fibre compozite → p. 157

Treceri

Elemente de trecere prin plafon și perete despărțitor Geberit Mapress CuNiFe, cu două capete drepte

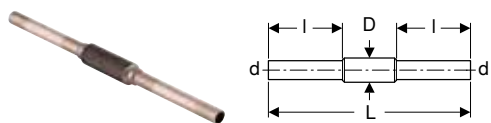

click & scan

Cod art.	DN	d, ø [mm]	D [cm]	L [cm]	l [cm]	EUR/buc.
92080	12	15	2,5	45	16,5	79,25
92082	20	22	3,4	45	16,5	83,87
92083	25	28	3,8	45	16,5	100,31
92084	32	35	4,5	45	16,5	115,11
92085	40	42	5,4	45	16,5	132,44
92086	50	54	7	45	16,5	146,52

Cod art.	DN	d, ø [mm]	D [cm]	L [cm]	l [cm]	EUR/buc.
92087	65	76,1	8,9	45	16,5	330,10
92088	80	88,9	10,8	45	16,5	368,93
92089	100	108	13,3	45	16,5	407,74

Accesorii pentru Geberit Mapress CuNiFe

Garnituri de sistem

O-ring Geberit Mapress CIIR negru



click & scan

Cod art.	DN	d, ø [mm]	EUR/buc.
90401	10	12	0,34
90402	12	15	0,36
90403	15	18	0,47
90404	20	22	0,47
90405	25	28	0,55
90406	32	35	0,55
90407	40	42	0,84
90408	50	54	0,84
90409	65	76,1	2,40
90410	80	88,9	3,27
90411	100	108	6,29

O-ring Geberit Mapress FKM albastru



click & scan

Cod art.	DN	d, ø [mm]	EUR/buc.
90881	10	12	2,43
90882	12	15	1,02
90883	15	18	1,24
90884	20	22	1,55
90885	25	28	1,84
90886	32	35	2,14
90887	40	42	3,82
90888	50	54	5,38
90891	65	76,1	15,71
90892	80	88,9	19,73
90893	100	108	43,93

Garnitură plată Geberit Mapress EPDM neagră

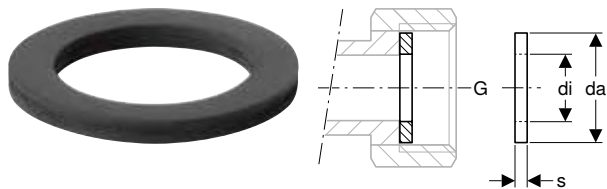

click & scan

Cod art.	G ["]	da [mm]	di, ø [mm]	s [mm]	EUR/buc.
90081	3/4"	24	13	2	1,92
90082	1"	30	19,6	2	1,92
90083	1 1/4"	39	25,6	2	1,92
90084	1 1/2"	45	32	2	1,92
90085	1 3/4"	50	39	2	1,92
90086	2 3/8"	66	51	3	1,92
90088	N 3"	84,7	76	3	2,40
90089	N 3 1/2"	97	84	3	2,89

N: Nou, livrabil din April 2024

Garnitură plată Geberit Mapress FPM verde

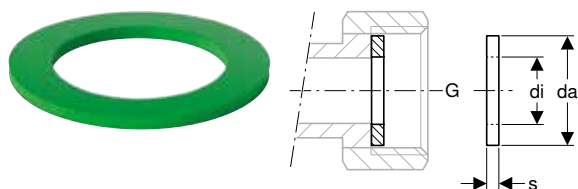

click & scan

Cod art.	G ["]	da [mm]	di, ø [mm]	s [mm]	EUR/buc.
90092	3/4"	24	13	2	2,01
90094	1"	30	19,6	2	3,03
90095	1 1/4"	39	25,6	2	3,03
90096	1 1/2"	45	32	2	3,96
90097	1 3/4"	50	39	2	3,96
90098	2 3/8"	66	51	2	10,35

Nou

Garnitură plată Geberit Mapress, din fibre compozite



click & scan
EUR/buc.

Cod art.	G ["]	da [mm]	di, ø [mm]	s [mm]	EUR/buc.
600.079.00.1	1/2"	18,4	10	2	1,11
600.080.00.1	3/4"	23,9	13	2	1,34
600.081.00.1	1"	30	19,6	2	1,47
600.082.00.1	1 1/8"	34,7	21	2	1,56
600.083.00.1	1 1/4"	38	25	2	1,78
600.084.00.1	1 1/4"	38,7	25,6	2	1,78
600.085.00.1	1 1/2"	44,6	32	2	1,93
600.087.00.1	1 3/4"	50,5	39	2	2,11
600.088.00.1	2"	56,4	42	2	2,22
600.089.00.1	2 1/4"	62,5	42	2	2,33
600.090.00.1	2 3/8"	66,2	51	2	2,67
600.091.00.1	2 1/2"	72	54	2	3,00
600.092.00.1	2 3/4"	78,3	57	2	3,33
600.093.00.1	3"	84,7	72,1	2	3,66
600.094.00.1	3 1/2"	97,1	84,9	2	4,00

Livrabil din April 2024



- Produs înlocuitor pentru cod art. 90072, 90074, 90075, 90076, 90077, 90078

Nou

Garnitură flanșă Geberit PN 6, din fibre compozite



click & scan
EUR/buc.

Cod art.	DN	da [mm]	di, ø [mm]	s [mm]	PN [bar]	
600.051.00.1	15	44	20	2	6	1,67
600.052.00.1	20	54	25	2	6	1,87
600.053.00.1	25	64	30	2	6	2,22
600.054.00.1	32	76	38	2	6	2,64
600.055.00.1	40	86	45	2	6	3,15
600.056.00.1	50	96	57	2	6	3,73
600.057.00.1	65	116	76	2	6	4,68
600.058.00.1	80	132	89	2	6	5,61
600.059.00.1	100	152	108	2	6	6,72

Livrabil din April 2024



- Produs înlocuitor pentru cod art. 91041, 91042, 91043, 91044, 91045, 91046, 91047, 91048, 91049

Nou

Garnitură flanșă Geberit PN 10/16, din fibre compozite



click & scan
EUR/buc.

Cod art.	DN	da [mm]	di, ø [mm]	s [mm]	PN [bar]	
600.041.00.1	15	50	20	2	10 / 16	1,89
600.042.00.1	20	60	25	2	10 / 16	2,11
600.043.00.1	25	70	30	2	10 / 16	2,51
600.044.00.1	32	82	38	2	10 / 16	2,98
600.045.00.1	40	92	45	2	10 / 16	3,55
600.046.00.1	50	107	57	2	10 / 16	4,22
600.047.00.1	65	127	76	2	10 / 16	5,28
600.048.00.1	80	142	89	2	10 / 16	6,34
600.049.00.1	100	162	108	2	10 / 16	7,61

Livrabil din April 2024



- Produs înlocuitor pentru cod art. 91031, 91032, 91033, 91034, 91035, 91036, 91037, 91038, 91039

Seturi de șuruburi pentru conexiuni cu flanșă

Set șurub Geberit pentru conexiune cu flanșă, din oțel CrNi

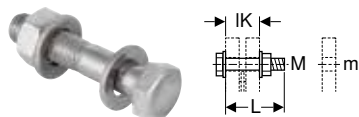

click & scan
EUR/buc.

Cod art.	M [mm]	m [mm]	L [cm]	IK [cm]	
91164	10	11	4,5	3,1	4,80
91165	10	11	5	3,6	4,80
91166	12	14	5	3	6,32
91167	12	14	5,5	3,5	6,32
91168	12	14	6	4	6,32
91169	16	18	5,5	3,3	9,45
91170	16	18	6	3,8	9,45
91171	16	18	6,5	4,3	9,45
91172	16	18	7	4,8	9,45
91173	16	18	8	5,8	9,45





Armături

Robineți cu închidere verticală	284
Cu racorduri prin presare Mapress	284
Robineți cu închidere verticală pentru montaj încastrat	284
Cu racorduri prin presare Mapress	284
Robineți cu închidere oblică	284
Cu racorduri prin presare Mapress	284
Robinete de închidere cu bilă	285
Cu racorduri prin presare Mapress	285
Robinete de închidere cu bilă pentru montaj încastrat	287
Cu racorduri prin presare Mapress	287
Clapete de sens	287
Cu racorduri prin presare Mapress	287



Robineți cu închidere verticală Cu racorduri prin presare Mapress

Ventil de închidere drept Geberit Mapress

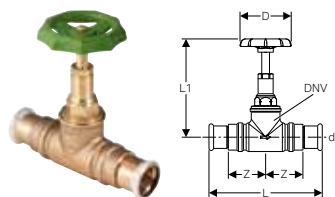

click & scan

Cod art.	DN	DNV	d, ø [mm]	D [cm]	L [cm]	L1 [cm]	Z [cm]	PN [bar]	EUR/buc.
94862	12	15	15	6	13	10,5	4,5	16	65,96
94863	15	15	18	6	13,2	10,5	4,6	16	69,61
94864	20	20	22	6	14,2	10,9	5	16	80,60
94865	25	25	28	7	15,8	13,7	5,6	16	102,59
94866	32	32	35	7	17,2	16,2	6	16	131,96

Robineți cu închidere verticală pentru montaj încastrat Cu racorduri prin presare Mapress

Robinet de închidere încastrat Geberit Mapress, cu rozetă de acoperire

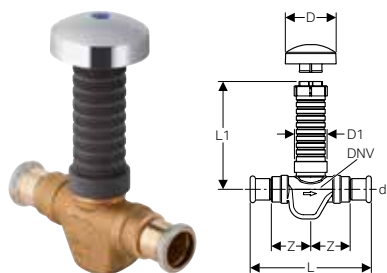

click & scan

Cod art.	DN	DNV	d, ø [mm]	D [cm]	D1 [cm]	L [cm]	L1 [cm]	Z [cm]	PN [bar]	EUR/buc.
94902	12	15	15	7	3,9	14	11	4,9	16	108,07
94903	15	15	18	7	3,9	14	11	5,5	16	108,07
94904	20	20	22	7	3,9	14,5	11	5,5	16	108,07
94905	25	25	28	7	4,6	18	11,5	6,8	16	164,87

Robineți cu închidere oblică Cu racorduri prin presare Mapress

Ventil de închidere înclinat Geberit Mapress

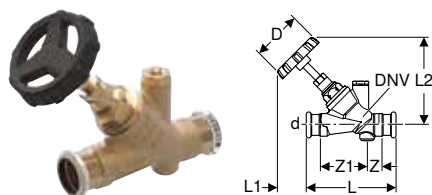

click & scan

Cod art.	DN	DNV	d, ø [mm]	D [cm]	L [cm]	L1 [cm]	L2 [cm]	Z [cm]	Z1 [cm]	PN [bar]	EUR/buc.
94882	12	15	15	6	9,4	3,7	9	1,5	3,9	16	73,26
94883	15	15	18	6	9,5	3,3	9	1,1	4,5	16	76,96
94884	20	20	22	6	10,9	3,2	10,5	2,2	4,5	16	87,94
94885	25	25	28	7	13	4,4	13,2	2,1	6,3	16	109,99
94886	32	32	35	7	15,1	5,6	15,4	2,9	7	16	139,23
94887	40	40	42	7	17,8	4,3	16,2	3	8,8	16	190,55
94888	50	50	54	9	21,4	5,5	19,3	4,4	10	16	230,82

Robinete de închidere cu bilă Cu racorduri prin presare Mapress

Robinet de închidere cu bilă Geberit Mapress Oțel Inox, cu buton de acționare

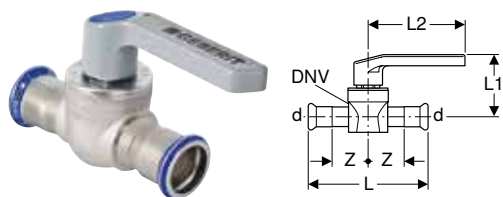

click & scan

Cod art.	DN	DNV	d, ø [mm]	L [cm]	L1 [cm]	L2 [cm]	Z [cm]	PN [bar]	EUR/buc.
94952	12	15	15	10,4	5,9	9,2	3,2	16	74,13
94953	15	15	18	10,4	5,9	9,2	3,2	16	80,00
94954	20	20	22	11,6	6,2	9,2	3,7	16	94,77
94955	25	25	28	13,4	7,1	12,4	4,4	16	112,60
94956	32	32	35	15,4	7,6	12,4	5,1	16	142,16
94957	40	40	42	17,7	8,3	14,7	5,9	16	171,80
94958	50	50	54	20,6	9	14,7	6,8	16	207,37

Robinet de închidere cu bilă Geberit Mapress, apă nepotabilă, cu buton de acționare

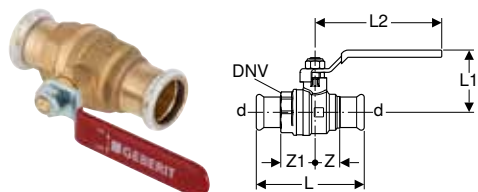

click & scan

Cod art.	DN	DNV	d, ø [mm]	L [cm]	L1 [cm]	L2 [cm]	Z [cm]	Z1 [cm]	PN [bar]	EUR/buc.
94922	12	15	15	7,7	4,4	8,5	1,7	2,4	16	18,04
94923	15	15	18	8	4,4	8,5	1,7	2,4	16	19,09
94924	20	20	22	8,9	5,2	10,6	2,1	2,9	16	24,91
94925	25	25	28	9,6	5,6	10,6	2,4	3,1	16	39,82
94926	32	32	35	10,9	6,1	10,6	2,7	3,4	16	49,77
94927	40	40	42	14,1	7,9	15,5	3,6	4,5	16	74,19
94928	50	50	54	15,7	9,4	17,5	3,9	4,8	16	99,51

Set prelungire tijă Geberit pentru robinet de închidere cu bilă pentru apă nepotabilă



click & scan

Cod art.	DNV	d, ø [mm]	L [cm]	EUR/buc.
94935	15	18	6	8,65
94936	20 / 25 / 32	22 / 28 / 35	6,5	8,65
94937	40	42	6,5	6,61
94938	50	54	6,5	8,55



Robinet de închidere cu bilă Geberit Mapress Oțel Inox, cu buton de acționare, fixat cu flanșă

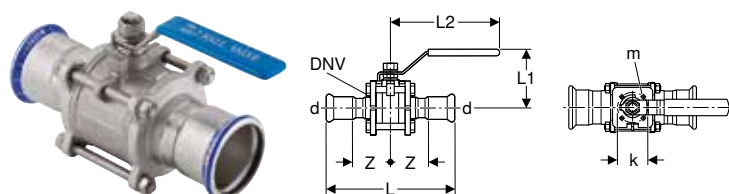

Cod art.	DN	DNV	d, ø [mm]	k [mm]	m [mm]	L [cm]	L1 [cm]	L2 [cm]	Z [cm]	PN [bar]	EUR/buc.
92100	12	15	15			12,2	5	9,3	4,1	40	86,21
92101	15	15	18			12,2	5	9,3	4,1	40	92,89
92102	20	20	22			13,3	5,6	10,3	4,5	40	120,78
92103	25	25	28			14,2	6,6	12,8	4,8	16	155,25
92104	32	32	35			17	7,5	12,8	5,9	16	189,73
92105	40	40	42			19,4	8,5	15,8	6,7	16	258,66
92106	50	50	54			22,1	9,6	15,8	7,5	16	344,90
92107	65	65	76,1	70	9	29,1	13,5	22,3	9,2	16	655,29
92108	80	80	88,9	70	9	33,3	14,5	35,8	10,6	16	965,69
92109	100	100	108	102	11	41,2	17,7	50	13,1	16	1655,42

Robinet de închidere cu bilă Geberit Mapress Oțel-Inox, cu buton de acționare și racord de furtun, fixat cu flanșă



Cod art.	DN	DNV	d, ø [mm]	G [in.]	L [cm]	L1 [cm]	L2 [cm]	Z [cm]	Z1 [cm]	PN [bar]	EUR/buc.
92110	12	15	15	3/4"	12,7	5	9,3	4,1	4,1	40	86,21
92112	20	20	22	1"	13,6	5,6	10,3	4,5	4,2	40	120,78

Robinet de închidere cu bilă Geberit Mapress CuNiFe, cu buton de acționare, prins cu flanșă

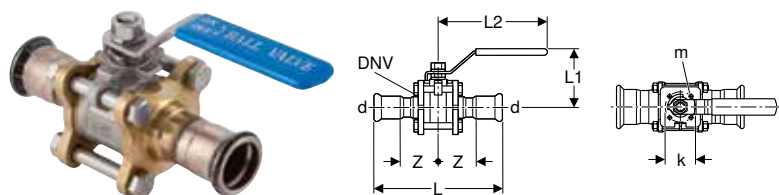

Cod art.	DN	DNV	d, ø [mm]	k [mm]	m [mm]	L [cm]	L1 [cm]	L2 [cm]	Z [cm]	PN [bar]	EUR/buc.
92120	12	15	15			12,2	5	9,3	4,1	13	180,99
92122	20	20	22			13,3	5,6	10,3	4,5	13	253,39
92123	25	25	28			14,2	6,6	12,8	4,8	13	298,59
92124	32	32	35			17	7,5	12,8	5,9	13	325,71
92125	40	40	42			19,4	8,5	15,8	6,7	13	407,18
92126	50	50	54			22,1	9,6	15,8	7,5	13	542,94
92127	65	65	76,1	70	9	29,1	13,5	22,3	9,2	10	859,56
92128	80	80	88,9	70	9	33,3	14,5	35,8	10,6	10	1266,78
92129	100	100	108	102	11	41,2	17,7	50	13,1	10	2171,47

Robinet de închidere cu bilă Geberit Mapress CuNiFe, cu buton de acționare și racord de furtun, prins cu flanșă

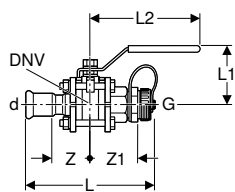

click & scan

Cod art.	DN	DNV	d, ø [mm]	G [...]	L [cm]	L1 [cm]	L2 [cm]	Z [cm]	Z1 [cm]	PN [bar]	EUR/buc.
92132	20	20	22	1"	13,6	5,6	10,3	4,5	4,2	13	258,43

Robinete de închidere cu bilă pentru montaj încastrat

Cu racorduri prin presare Mapress

Robinet de închidere cu bilă încastrat Geberit Mapress

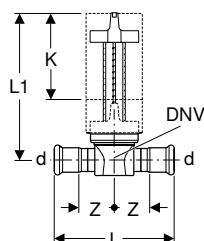

click & scan

Cod art.	DN	DNV	d, ø [mm]	L [cm]	L1 [cm]	Z [cm]	K [cm]	PN [bar]	EUR/buc.
94912	12	15	15	10,4	12,6	3,2	7,3	16	74,13
94913	15	15	18	10,3	12,6	3,2	7,3	16	75,88
94914	20	20	22	11,7	12,6	3,8	7,3	16	94,77

Clapete de sens

Cu racorduri prin presare Mapress

Clapetă de sens Geberit Mapress Oțel-Inox cu flanșă

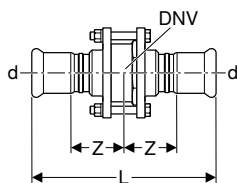

click & scan

Cod art.	DN	DNV	d, ø [mm]	L [cm]	Z [cm]	PN [bar]	EUR/buc.
92140	12	15	15	11,1	3,8	40	148,33
92142	20	20	22	12	3,9	40	186,24
92143	25	25	28	12,6	4	16	224,18
92144	32	32	35	14,7	4,8	16	275,92
92145	40	40	42	16,7	5,3	16	327,65
92146	50	50	54	18,5	5,8	16	507,02
92147	65	65	76,1	25,5	7,5	16	896,74
92148	80	80	88,9	28,5	8,3	16	1327,79
92149	100	100	108	34,6	9,8	16	1827,88



Armături

Clapete de sens

Cu racorduri prin presare Mapress

Clapetă de sens Geberit Mapress CuNiFe, fixată cu flanșă

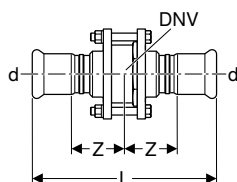

click & scan

Cod art.	DN	DNV	d, ø [mm]	L [cm]	Z [cm]	PN [bar]	EUR/buc.
92150	12	15	15	11,1	3,8	13	311,27
92152	20	20	22	12	3,9	13	390,90
92153	25	25	28	12,6	4	13	479,92
92154	32	32	35	14,7	4,8	13	495,37
92155	40	40	42	16,7	5,3	13	526,04
92156	50	50	54	18,5	5,8	13	798,06
92157	65	65	76,1	25,5	7,5	10	1176,25
92158	80	80	88,9	28,5	8,3	10	1741,73
92159	100	100	108	34,6	9,8	10	2397,66





Unelte

Unelte pentru Geberit Silent-db20 / Geberit HDPE	292
Unelte de electrofuziune	292
Accesorii pentru unelte de electrofuziune	292
Unelte pentru sudură cap la cap	293
Vedere de ansamblu asupra sortimentului – Unelte pentru sudarea cap la cap Geberit.	293
Accesorii pentru unelte pentru sudură cap la cap	295
Prezentare generală a gamei de accesorii – Dispozitive manuale și electrice de îndreptat fețe Geberit.	295
Unelte de prelucrare a țevilor	302
Accesorii pentru unelte de prelucrare a țevilor	305
Unelte pentru Geberit FlowFit	306
Prezentare generală a gamei de produse – Compatibilitate Geberit FlowFit [1] și [2].	306
Unelte de presare manuală	307
Compatibilitatea uneltelor de presare [1].	308
Compatibilitatea uneltelor de presare [2]	309
Unelte pentru prelucrarea țevilor	310
Dop de etanșare	311
Echipament de testare	312
Aparate de presare cu unelte	313
Accesorii	313
Unelte pentru Geberit Mapress	317
Privire de ansamblu asupra sortimentelor – Compatibilitate Geberit Mapress [1], [2], și [2XL]	317
Vedere de ansamblu asupra sortimentului – Coliere de presare Geberit.	319
Compatibilitate unelte de presare [1]	319
Compatibilitate unelte de presare [2]	320
Compatibilitate unelte de presare [2XL].	322
Compatibilitate unelte de presare [3]	323
Unelte de prelucrare a țevilor	324
Dopuri de etanșare	326
Accesorii	327
Aparate de presare	328
Compatibilitate aparate de presare [1]	328
Compatibilitate aparate de presare [2].	329
Compatibilitate aparate de presare [2XL]	331
Trusă universală	332
Trusă universală	332



Unelte

Unelte pentru Geberit Silent-db20 / Geberit HDPE
Unelte de electrofuziune

Unelte pentru Geberit Silent-db20 / Geberit HDPE

Unelte de electrofuziune

Mașină de electrofuziune Geberit ESG 3 230 V



click & scan

Cod art.	Clasă de protecție	Putere consumată (W)	Greutate element principal	EUR/buc.
359.911.P0.1	I	≤ 1085	6,51	492,06

Mașină de electrofuziune Geberit ESG Light 230 V



click & scan

Cod art.	Clasă de protecție	Putere consumată (W)	Greutate element principal	EUR/buc.
359.910.P0.1	II	1120	2	408,58

Accesorii pentru unelte de electrofuziune

Set de accesorii Geberit pentru sudare termică a mufelor de electrofuziune cu fuzibil termic integrat













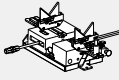
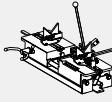

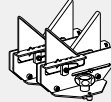
click & scan

Cod art.	d, ø [mm]	EUR/buc.
356.116.00.1	200–315	1550,38

Unelte pentru sudură cap la cap











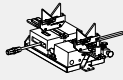
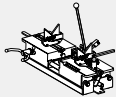

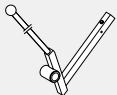

Vedere de ansamblu asupra sortimentului – Unelte pentru sudarea cap la cap Geberit

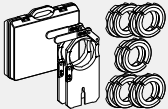
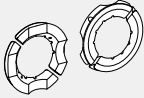
Geberit România, Versiune: December 2023

		Mașină de sudură Geberit Media		Mașină de sudură Geberit Universal	
		359.662.00.1		356.201.00.1	
					
Inclus în lista elementelor livrate					
359.778.00.1 Braț suport de fixare a plitei pentru mașini de sudură Media și Universal Geberit pentru plite de sudură KSS-160 / KSS-200			✓		✓
357.800.00.1 Set suporturi pentru țevi Geberit d50–160, pentru mașini de sudură Media și Universal			✓		✓
357.449.00.1 Set suporturi de țevă Geberit d200, pentru mașină de sudură Universal					✓
356.831.00.1 Soclu Geberit pentru mașini de sudură Media și Universal			✓		✓
358.729.00.1 Suport Geberit pivotant, pentru mașini de sudură Media și Universal			✓		✓
242.462.00.1 Suport Geberit pivotant, pentru mașini de sudură Media și Universal					✓
359.663.00.1 Cutie de transport Geberit Media goală			✓		
359.641.P0.2 Plită de sudură Geberit KSS-160 230 V					
359.814.00.1 Set dispozitive de întindere Geberit					
Unelte care se comandă suplimentar (selecție)					
Dispozitiv de îndreptat fețe Geberit d40–160	HSS, d40-160		359.799.00.1		359.799.00.1
Dispozitiv electric de îndreptat fețe Geberit d40–160, 230 V	HSS		359.046.xx.1		359.046.xx.1
Dispozitiv electric de îndreptat fețe Geberit d40–200, 230 V	HSS		-		359.082.xx.1
Dispozitiv electric de îndreptat fețe Geberit d200–315, 230 V	HSS		-		359.060.xx.1
Plită de sudură Geberit KSS-160 230 V			359.641.xx.2		359.641.xx.2

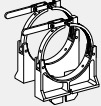

Geberit România, Versiune: December 2023

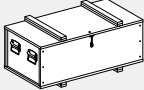
		Mașină de sudură Geberit Media	Mașină de sudură Geberit Universal
		359.662.00.1	356.201.00.1
			
Plită de sudură Geberit KSS-200 230 V		-	359.665.xx.2
Plită de sudură Geberit KSS-315 230 V		-	359.675.xx.2
Suport pentru plită de sudură Geberit pentru plita de sudură KSS-160 / KSS-200		359.886.00.2	359.886.00.2
Suport pentru plită de sudură Geberit pentru mașină de sudură Universal pentru plita de sudură KSS-315		-	359.673.00.1
Husă de protecție Geberit, din piele	Pentru KSS-160	359.684.00.1	359.684.00.1
	Pentru KSS-200	-	359.696.00.1
Set dispozitive de întindere Geberit		359.8xx.00.1	359.8xx.00.1
Set fălci de inserție Geberit cu bacuri de prindere d110		359.059.00.1	359.059.00.1
Set fălci de montaj Geberit pentru bacuri de prindere d110		359.05x.00.1	359.05x.00.1
Trusă Geberit pentru fălci de montaj		359.062.00.1	359.062.00.1
Set dispozitive de întindere Geberit, cu prisme de susținere d135		359.820.00.1	359.820.00.1
Set dispozitive de întindere Geberit		-	359.884.00.1
Set dispozitive de întindere Geberit		-	359.83x.00.1
Prismă de susținere Geberit d200-315, pentru mașină de sudură Universal		-	359.691.00.1
Suport Geberit pivotant, pentru mașini de sudură Media și Universal		242.462.00.1	242.462.00.1
Cutie de transport Geberit Media goală		359.663.00.1	-
Cutie de transport Geberit Universal goală		-	359.698.00.0



click & scan

Mașină de sudură Geberit Media



Cod art.	d, ø [mm]	L [cm]	B [cm]	H [cm]	Greutate element principal	EUR/buc.
359.662.00.1	40-160	84	41	43	25,2	1287,53

Mașină de sudură Geberit Universal



click & scan

Cod art.	d, ø [mm]	L [cm]	B [cm]	H [cm]	Greutate element principal	EUR/buc.
356.201.00.1	40-315	77	43	43,5	74	2266,99

Accesorii pentru unelte pentru sudură cap la cap

Prezentare generală a gamei de accesorii – Dispozitive manuale și electrice de îndreptat fețe Geberit

Geberit România, Versiune: December 2023

	Dispozitiv de îndreptat fețe Geberit d40-160	Dispozitiv electric de îndreptat fețe Geberit d40-160, 230 V	Dispozitiv electric de îndreptat fețe Geberit d40-200, 230 V	Dispozitiv electric de îndreptat fețe Geberit d200-315, 230 V
Tensiune nominală			230 V AC	
Dimensiune	d40-160		d40-200	d200-315
Oțel rapid de înaltă performanță ¹⁾	359.799.00.1	359.046.P2.1 359.046.P3.1 359.046.P5.1 359.046.P6.1 359.046.P7.1 359.046.Q4.1 359.046.P9.1	359.082.P2.1 359.082.P3.1 359.082.P5.1 359.082.P6.1 359.082.P7.1 359.082.Q4.1 359.082.P9.1	359.060.P2.1 359.060.P3.1 359.060.P5.1 359.060.P7.1 359.060.Q4.1 359.060.P9.1
HM ²⁾				

Accesorii				
Lamă oțel rapid de înaltă performanță ¹⁾				
358.759.00.1				
358.760.00.1	2 x	1 x	-	-
358.759.00.1				
358.760.00.1	-	-	1 x	-
357.600.00.1				
357.599.00.1				
357.751.00.1	-	-	-	2 x
Lamă HM ³⁾				
240.474.00.1	2 x	1 x	2 x	-

¹⁾ Pentru Geberit HDPE

²⁾ Pentru Geberit HDPE și Geberit Silent-db20

³⁾ Pentru Geberit HDPE și Geberit Silent-db20, set de 2 bucăți



Unelte

Unelte pentru Geberit Silent-db20 / Geberit HDPE
Accesorii pentru unelte pentru sudură cap la cap

Plită de sudură Geberit KSS-160 230 V



[click & scan](#)
EUR/buc.

Cod art.	d, \emptyset [mm]	Putere consumată (W)	Greutate element principal	
359.641.P0.2	40-160	800	2,944	197,36

Accesorii

- Husă de protecție Geberit, din piele → p. 301

Plită de sudură Geberit KSS-200 230 V



[click & scan](#)
EUR/buc.

Cod art.	d, \emptyset [mm]	Putere consumată (W)	Greutate element principal	
359.665.P0.2	40-200	1300	4,5	225,38

Accesorii

- Suport pentru plită de sudură Geberit pentru plita de sudură KSS-160 / KSS-200 → p. 296
- Husă de protecție Geberit, din piele → p. 301

Plită de sudură Geberit KSS-315 230 V



[click & scan](#)
EUR/buc.

Cod art.	d, \emptyset [mm]	Putere consumată (W)	Greutate element principal	
359.675.P0.2	200-315	1300	5,348	507,87

Accesorii

- Suport pentru plită de sudură Geberit pentru mașină de sudură Universal pentru plita de sudură KSS-315 → p. 296

Suport pentru plită de sudură Geberit pentru mașină de sudură Universal pentru plita de sudură KSS-315



[click & scan](#)

Cod art.		EUR/buc.
359.673.00.1		174,41

Suport pentru plită de sudură Geberit pentru plita de sudură KSS-160 / KSS-200



[click & scan](#)

Cod art.		EUR/buc.
359.886.00.2		29,42

Braț suport de fixare a plitei pentru mașini de sudură Media și Universal Geberit pentru plite de sudură KSS-160 / KSS-200



click & scan

Cod art.	EUR/buc.
359.778.00.1	86,01

Dispozitiv electric de îndreptat fețe Geberit d40–160, 230 V



click & scan

Cod art.	d, ø [mm]	Putere consumată (W)	Greutate element principal	EUR/buc.
359.046.P2.1	40–160	750	5,894	741,66

Accesorii

- Cuțite Geberit din HSS pentru dispozitiv de îndreptat fețe, pentru dispozitiv electric de îndreptat fețe d40–160 și dispozitiv electric de îndreptat fețe d40–200 → p. 298

Dispozitiv electric de îndreptat fețe Geberit d40–200, 230 V



click & scan

Cod art.	d, ø [mm]	Putere consumată (W)	Greutate element principal	EUR/buc.
359.082.P2.1	40–200	750	6,303	898,17

Accesorii

- Cuțite Geberit din HSS pentru dispozitiv de îndreptat fețe, pentru dispozitiv electric de îndreptat fețe d40–160 și dispozitiv electric de îndreptat fețe d40–200 → p. 298

Dispozitiv electric de îndreptat fețe Geberit d200–315, 230 V



click & scan

Cod art.	d, ø [mm]	Putere consumată (W)	Greutate element principal	EUR/buc.
359.060.P2.1	200–315	550	11,593	1373,88

Accesorii

- Cuțite Geberit pentru dispozitiv electric de îndreptat fețe d200–315 → p. 298



Unelte

Unelte pentru Geberit Silent-db20 / Geberit HDPE
Accesorii pentru unelte pentru sudură cap la cap

Dispozitiv de îndreptat fețe Geberit d40–160



click & scan

Cod art.	d, ø [mm]	EUR/buc.
359.799.00.1	40–160	423,15

Accesorii

- Cuțite Geberit din HSS pentru dispozitiv de îndreptat fețe, pentru dispozitiv electric de îndreptat fețe d40–160 și dispozitiv electric de îndreptat fețe d40–200 → p. 298

Cuțite Geberit din HSS pentru dispozitiv de îndreptat fețe, pentru dispozitiv electric de îndreptat fețe d40–160 și dispozitiv electric de îndreptat fețe d40–200



click & scan

Cod art.	d, ø [mm]	Lamă	EUR/buc.
357.599.00.1	200	Dreapta, șlefuit	22,50
357.600.00.1	200	Stânga șlefuit	22,50
358.759.00.1	40–200	Stânga	19,95
358.760.00.1	40–200	Dreapta	19,95

De comandat suplimentar

- Șuruburi cu cap înecat M3 x 6–8,8, galvanizate (din comerț)

Set de cuțite Geberit din HM, pentru dispozitiv de îndreptat fețe, dispozitiv electric de îndreptat fețe d40–160 și dispozitiv electric de îndreptat fețe d40–200



click & scan

Cod art.	d, ø [mm]	EUR/buc.
240.474.00.1	40–200	54,26

Cuțite Geberit pentru dispozitiv electric de îndreptat fețe d200–315



click & scan

Cod art.	EUR/buc.
357.751.00.1	38,10

De comandat suplimentar

- Șuruburi cu cap înecat M3 x 6–8,8, galvanizate (din comerț)

Set fălci de inserție Geberit cu bacuri de prindere d110



click & scan

Cod art.	EUR/buc.
359.059.00.1	821,82

Set fălci de montaj Geberit pentru bacuri de prindere d110



click & scan

Cod art.	d, ø [mm]	EUR/buc.
359.052.00.1	50 / 110	121,39
359.053.00.1	56 / 110	121,39
359.054.00.1	63 / 110	121,39
359.056.00.1	75 / 110	121,39
359.057.00.1	90 / 110	121,39

Set dispozitive de întindere Geberit



click & scan

Cod art.	DN	d, ø [mm]	EUR/buc.
359.817.00.1	40	40	162,13
359.818.00.1	50	50	155,35
359.811.00.1	56	56	154,48
359.809.00.1	60	63	154,48
359.812.00.1	70	75	169,27
359.813.00.1	90	90	175,55
359.814.00.1	100	110	187,99
359.819.00.1	125	125	187,01
359.822.00.1	125	135	244,98
359.816.00.1	150	160	235,62

Set dispozitive de întindere Geberit d200



click & scan

Cod art.	DN	d, ø [mm]	EUR/buc.
359.884.00.1	200	200	398,86



Unelte

Unelte pentru Geberit Silent-db20 / Geberit HDPE
Accesorii pentru unelte pentru sudură cap la cap

Set dispozitive de întindere Geberit



[click & scan](#)
EUR/buc.

Cod art.	d, ø [mm]	EUR/buc.
359.835.00.1	250	647,77
359.836.00.1	315	689,34

Set dispozitive de întindere Geberit, cu prisme de susținere d135



[click & scan](#)

Cod art.	DN	d, ø [mm]	EUR/buc.
359.820.00.1	125	135	349,24

Set suporturi de țevă Geberit d200, pentru mașină de sudură Universal



[click & scan](#)
EUR/buc.

Cod art.	EUR/buc.
357.449.00.1	75,04

Set suporturi pentru țevi Geberit d50–160, pentru mașini de sudură Media și Universal



[click & scan](#)
EUR/buc.

Cod art.	d, ø [mm]	EUR/buc.
357.800.00.1	50-160	89,46

Prismă de susținere Geberit d200–315, pentru mașină de sudură Universal



[click & scan](#)
EUR/buc.

Cod art.	d, ø [mm]	EUR/buc.
359.691.00.1	200-315	136,06

Set de accesorii Geberit pentru unelte pentru sudarea cap la cap d200-315, Universal

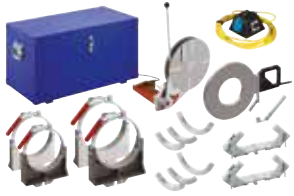

[click & scan](#)

Cod art.	d, ø [mm]	Putere consumată (W)	EUR/buc.
359.009.P0.1	200-315	900	4834,28

Husă de protecție Geberit, din piele



[click & scan](#)

Cod art.	EUR/buc.
359.696.00.1	21,82

Husă de protecție Geberit, din piele



[click & scan](#)

Cod art.	EUR/buc.
359.684.00.1 S	23,37

S: Sfârșit de producție

Cutie de transport Geberit Media goală



[click & scan](#)

Cod art.	d, ø [mm]	EUR/buc.
359.663.00.1	40-160	313,72

Cutie de transport Geberit Universal goală



[click & scan](#)

Cod art.	d, ø [mm]	EUR/buc.
359.698.00.0	40-315	215,97

Trusă Geberit pentru fălci de montaj



[click & scan](#)

Cod art.	EUR/buc.
359.062.00.1	42,26



Unelte

Unelte pentru Geberit Silent-db20 / Geberit HDPE
Unelte de prelucrare a țevilor

Suport Geberit pivotant, pentru mașini de sudură Media și Universal



click & scan
EUR/buc.

Cod art.	d, ø [mm]	
242.462.00.1	135 / 160	22,69
358.729.00.1	75-125	46,64

Soclu Geberit pentru mașini de sudură Media și Universal



click & scan
EUR/buc.

Cod art.		
356.831.00.1		22,82

Unelte de prelucrare a țevilor

Aparat de tăiat țevi Geberit, pentru țevi din material plastic



click & scan
EUR/buc.

Cod art.	d, ø [mm]	
358.502.00.1	6-66	57,59
358.503.00.1	48-116	78,14
358.504.00.1	100-168	110,78

Accesorii

- Set discuri de tăiere Geberit pentru aparat de tăiat țevi din plastic → p. 302

Set discuri de tăiere Geberit pentru aparat de tăiat țevi din plastic



click & scan
EUR/buc.

Cod art.	d, ø [mm]	
242.827.00.1	6-66	19,28
242.828.00.1	48-168	27,14

Aparat de tăiat țevi Geberit, pentru țevi din material plastic



click & scan
EUR/buc.

Cod art.	d, ø [mm]	
359.860.00.1	200-315	489,54

Accesorii

- Disc de tăiere Geberit pentru aparat de tăiat țevi din plastic d200-315 → p. 303

Disc de tăiere Geberit pentru aparat de tăiat țevi din plastic d200–315



click & scan

EUR/buc.

40,87

Cod art.

357.799.00.1

Răzuitor manual pentru conducte Geberit



click & scan

EUR/buc.

24,29

Cod art.

356.118.00.1

Răzuitor manual pentru conducte Geberit în trusă



click & scan

Cod art.

359.912.00.1

d, ø
[mm]

63–160

EUR/buc.

379,35

Accesorii

- Trusă Geberit pentru răzuitor manual pentru conducte d63–160 → p. 305

Răzuitor pentru conducte Geberit în trusă



click & scan

Cod art.

359.915.00.1

d, ø
[mm]

110

EUR/buc.

155,73

Set răzuitoare țevă Geberit în valiză



click & scan

Cod art.

359.916.00.1

d, ø
[mm]

56 / 63 / 75 / 90 / 110

EUR/buc.

679,00



Unelte

Unelte pentru Geberit Silent-db20 / Geberit HDPE
Unelte de prelucrare a țevilor

Răzuitor țevă Geberit



click & scan
EUR/buc.

Cod art.	DN	d, ø [mm]	
359.922.00.1	56	56	122,05
359.923.00.1	60	63	122,05
359.924.00.1	70	75	122,05
359.925.00.1	90	90	122,05
359.926.00.1	100	110	122,05

Accesorii

- Trusă Geberit pentru set răzuitor țevă → p. 305

Aparat de șanfrenare Geberit



click & scan

Cod art.	d, ø [mm]	EUR/buc.
358.501.00.1	32-160	63,17

Cuțit de debavurare Geberit



click & scan
EUR/buc.

Cod art.		EUR/buc.
359.720.00.1		6,46

Unealtă de reparații Geberit HDPE 230 V



click & scan

Cod art.	d, ø [mm]	Putere consumată (W)	EUR/buc.
359.048.P0.1	40-160	180	497,95

Rondelă de reparații Geberit



click & scan
EUR/buc.

Cod art.	d, ø [mm]	EUR/buc.
853.650.16.1	40-160	3,09

Accesorii pentru unelte de prelucrare a țevilor

Trusă Geberit pentru răzuitor manual pentru conducte d63-160



[click & scan](#)

Cod art.	EUR/buc.
359.914.00.1	42,81

Trusă Geberit pentru set răzuitor țeavă



[click & scan](#)

Cod art.	EUR/buc.
359.930.00.1	103,60

Cuțite Geberit pentru răzuitor manual pentru conducte d56-135



[click & scan](#)











Cod art.	EUR/buc.
240.669.00.1	48,07





Unelte pentru Geberit FlowFit

Prezentare generală a gamei de produse – Compatibilitate Geberit FlowFit [1] și [2]

Geberit România, Versiune: December 2023

		Cod art.	Dimensiune
Clește manual de presare			
	Dispozitiv pentru apăsare cu mâna Unealtă de presare manuală Geberit FlowFit, în trusă	691.031.00.1	16 mm 20 mm 25 mm 32 mm 40 mm
	Clește manual de presare Geberit FlowFit	691.030.00.1	16 mm 20 mm 25 mm 32 mm 40 mm
Compatibilitate [1]			
	Fălci de presare Geberit FlowFit, în cutie	655.081.00.1	16 mm 20 mm 25 mm 32 mm 35 mm
	Cutie Geberit FlowFit echipată cu unelte [1]	655.078.00.1	16 mm 20 mm 25 mm 32 mm 40 mm
	Set fălcă de presare Geberit FlowFit [1]	691.035.00.1	16 mm 20 mm 25 mm 32 mm 40 mm
	Fălci de presare Geberit FlowFit [1]	691.032.00.1	16 mm 20 mm 25 mm 32 mm 40 mm
Compatibilitate [2]			
	Fălci de presare Geberit FlowFit, în cutie	655.082.00.1	16 mm 20 mm 25 mm 32 mm 40 mm
		655.083.00.1	16 mm 20 mm 25 mm 32 mm 40 mm 50 mm 63 mm 75 mm
	Cutie Geberit FlowFit echipată cu unelte [2]	655.084.00.1	16 mm 20 mm 25 mm 32 mm 40 mm
		655.079.00.1	16 mm 20 mm 25 mm 32 mm 40 mm 50 mm 63 mm 75 mm

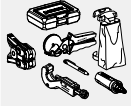
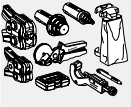
Geberit România, Versiune: December 2023

		Cod art.	Dimensiune
	Geberit FlowFit pressing jaw set [2]	691.036.00.1	16 mm
			20 mm
	Geberit FlowFit pressing jaw set [2]	691.037.00.1	25 mm
			32 mm
	Gheară de presare Geberit FlowFit [2]	691.033.00.1	40 mm
			16 mm
		691.034.00.1	20 mm
			25 mm
			32 mm
			40 mm
			50 mm
			63 mm
			75 mm

Unelte de presare manuală

Dispozitiv pentru apăsare cu mâna Unealtă de presare manuală Geberit FlowFit, în trusă



click & scan

Cod art.	d, ø [mm]	EUR/buc.
691.031.00.1	16 / 20 / 25 / 32 / 40	294,64

Accesorii

- Set de reumplere Geberit FlowFit pentru PowerTest → p. 312

Nou

Clește manual de presare Geberit FlowFit



click & scan

Cod art.	d, ø [mm]	EUR/buc.
691.030.00.1	16 / 20 / 25 / 32 / 40	164,98

Livrabil din April 2024

Accesorii

- Trusă pentru unealta de presare manuală → p. 313
- Geberit FlowFit PowerTest, în trusă → p. 312



Unelte

Unelte pentru Geberit FlowFit
Compatibilitatea uneltelor de presare [1]

Compatibilitatea uneltelor de presare [1]

Nou

Trusă Geberit FlowFit echipată cu unelte [1]



click & scan

Cod art.	Compatibilitate	d, ø [mm]	B [cm]	H [cm]	T [cm]	EUR/buc.
655.078.00.1	[1] 16 / 20 / 25 / 32 / 40		50,6	34,9	16	438,18

Livrabil din April 2024

Set fălcă de presare Geberit FlowFit [1]



click & scan

Cod art.	Compatibilitate	d, ø [mm]	EUR/buc.
691.035.00.1	[1]	16 / 20 / 25 / 32 / 40	377,12

Accesorii

- Trusă Geberit FlowFit pentru aparate de presare ACO 103 [1] → p. 314
- Trusă Geberit FlowFit pentru unelte de prelucrare → p. 313
- Aparat de presare Geberit ACO 103plus [1] → p. 328



- Adecvat pentru trusa Geberit cu modul de trusă 10-O
- Cod articol: 691.156.00.1, 691.153.00.1
- Adecvat pentru trusa Geberit cu modul de trusă 10-P
- Nr. art.: 691.161.00.1

Falcă de presare Geberit FlowFit [1]



click & scan

Cod art.	Compatibilitate	d, ø [mm]	EUR/buc.
691.032.00.1	[1]	16 / 20 / 25 / 32 / 40	235,71

Accesorii

- Dispozitiv de colectare Geberit FlowFit pentru indicatoare de presare → p. 315
- Trusă Geberit FlowFit pentru aparate de presare ACO 103 [1] → p. 314
- Trusă Geberit FlowFit pentru unelte de prelucrare → p. 313
- Geberit FlowFit PowerTest, în trusă → p. 312
- Aparat de presare Geberit ACO 103plus [1] → p. 328



- Adecvat pentru trusa Geberit cu modul de trusă 10-O
- Cod articol: 691.156.00.1, 691.153.00.1
- Adecvat pentru trusa Geberit cu modul de trusă 10-P
- Cod articol: 691.161.00.1, 655.078.00.1

Compatibilitatea uneltelor de presare [2]

Nou

Trusă Geberit FlowFit echipată cu unelte [2]



click & scan

Cod art.	Compatibilitate	d, ø [mm]	B [cm]	H [cm]	T [cm]	EUR/buc.
655.079.00.1	[2]	16 / 20 / 25 / 32 / 40 / 50 / 63 / 75	50,6	34,9	16	874,21
655.084.00.1	[2]	16 / 20 / 25 / 32 / 40	50,6	34,9	16	461,93

Livrabil din April 2024

Nou

Set fălci de presare Geberit FlowFit [2]



click & scan

Cod art.	Compatibilitate	d, ø [mm]	EUR/buc.
691.036.00.1	[2]	16 / 20 / 25 / 32 / 40	400,69
691.037.00.1	[2]	16 / 20 / 25 / 32 / 40 / 50 / 63 / 75	813,18

Livrabil din April 2024

Accesorii

- Trusă Geberit FlowFit pentru unelte de prelucrare → p. 313
- Trusă Geberit FlowFit pentru aparate de presare ECO 203 și ACO 203 [2] → p. 314
- Trusă Geberit FlowFit pentru aparate de presare EFP 203 [2] → p. 314
- Aparat de presare Geberit ACO 203plus [2] → p. 329
- Aparat de presare Geberit ECO 203 [2] → p. 330
- Aparat de presare Geberit EFP 203 [2] → p. 330



- Adecvat pentru trusa Geberit cu modul de trusă 10-P
- Cod articol: 691.161.00.1, 655.079.00.1
- Adecvat pentru trusa Geberit cu modul de trusă 20-I și 20-J
- Cod articol: 691.154.00.1, 691.155.00.1, 691.157.00.1, 691.158.00.1



Unelte

Unelte pentru Geberit FlowFit
Unelte pentru prelucrarea țevilor

Falcă de presare Geberit FlowFit [2]



click & scan

Cod art.	Compatibilitate	d, ø [mm]	EUR/buc.
691.033.00.1	[2]	16 / 20 / 25 / 32 / 40	259,28
691.034.00.1	[2]	50 / 63 / 75	412,48

Accesorii

- Trusă Geberit FlowFit pentru unelte de prelucrare → p. 313
- Trusă Geberit FlowFit pentru aparate de presare ECO 203 și ACO 203 [2] → p. 314
- Trusă Geberit FlowFit pentru aparate de presare EFP 203 [2] → p. 314
- Aparat de presare Geberit ACO 203plus [2] → p. 329
- Aparat de presare Geberit ECO 203 [2] → p. 330
- Aparat de presare Geberit EFP 203 [2] → p. 330



- Adecvat pentru trusa Geberit cu modul de trusă 10-P
- Cod articol: 691.161.00.1, 655.079.00.1
- Adecvat pentru trusa Geberit cu modul de trusă 20-I și 20-J
- Cod articol: 691.154.00.1, 691.155.00.1, 691.157.00.1, 691.158.00.1

Unelte pentru prelucrarea țevilor

Aparat Geberit de tăiat țevi ML



click & scan

EUR/buc.

Cod art.	d, ø [mm]	EUR/buc.
690.112.00.1	16-50	40,54
690.115.00.1	32-75	77,03

Instrument de calibrare Geberit FlowFit



click & scan

EUR/buc.

Cod art.	d, ø [mm]	L [cm]	EUR/buc.
690.300.00.1	16 / 20 / 25 / 32 / 40	15,8	7,08
690.301.00.1	N 50 / 63 / 75	15,3	9,42

N: Nou, livrabil din April 2024

Nou

Unealtă de debavurare și calibrare Geberit FlowFit pentru sisteme terțe



click & scan

EUR/buc.

Cod art.	d, ø [mm]	s [mm]	EUR/buc.
690.310.00.1	16	2-2,2	32,24
690.311.00.1	20	2-2,25	32,24

Livrabil din April 2024

Cod art.	d, ø [mm]	s [mm]	EUR/buc.
690.312.00.1	20	2,8–2,9	32,24
690.313.00.1	25	2,5–3	32,24
690.314.00.1	25	3,5–3,7	32,24

Livrabil din April 2024

Creion de gresare Geberit cu mină retractabilă



click & scan

Cod art.	Culoare/suprafață	EUR/buc.
690.102.00.1	Galben	6,97

Foarfecă Geberit



click & scan

Domenii de utilizare

- Pentru scurtarea țevilor Geberit PB, a țevilor ML și a țevilor de protecție
- Pentru tăierea la lungime a țevilor Geberit Volex și a tuburilor de protecție

Cod art.	d, ø [mm]	EUR/buc.
650.921.00.2	14–26	65,90

Dop de etanșare

Nou

Dop de etanșare Geberit FlowFit pentru capăt de țevă

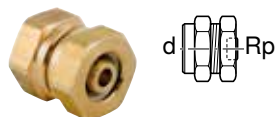

click & scan

Cod art.	d, ø [mm]	Rp ["]	EUR/buc.
653.940.26.1	16	1/2"	8,17
654.940.26.1	20	1/2"	9,74
655.940.26.1	25	1/2"	10,72
656.940.26.1	32	1/2"	12,16
657.940.26.1	40	1/2"	26,92
658.940.26.1	50	1/2"	38,29
659.940.26.1	63	1/2"	64,21

Livrabil din April 2024



Echipament de testare

Nou

Set de reumplere Geberit FlowFit pentru PowerTest

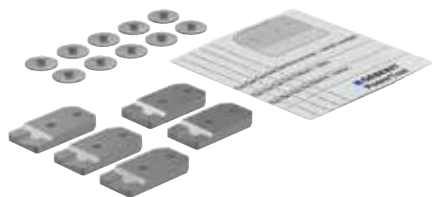

click & scan

Cod art.	d, ø [mm]	EUR/buc.
690.917.00.1	16 / 20 / 25 / 32 / 40	8,25
690.918.00.1	50 / 63 / 75	9,42

Livrabil din April 2024

Nou

Geberit FlowFit PowerTest, în trusă



click & scan

Cod art.	d, ø [mm]	EUR/buc.
690.915.00.1	16 / 20 / 25 / 32 / 40	17,70
690.916.00.1	50 / 63 / 75	21,21

Livrabil din April 2024

Accesorii

- Set de reumplere Geberit FlowFit pentru PowerTest → p. 312
- Geantă Geberit FlowFit pentru PowerTest → p. 312

Nou

Geantă Geberit FlowFit pentru PowerTest



click & scan

EUR/buc.

Cod art.	d, ø [mm]	EUR/buc.
690.937.00.1	16 / 20 / 25 / 32 / 40	2,37
690.938.00.1	50 / 63 / 75	3,54

Livrabil din April 2024

Aparate de presare cu unelte

Aparat de presare ACO 103plus cu unelte Geberit FlowFit [1]



click & scan

Cod art.	Compatibilitate	d, \varnothing [mm]	Tensiune nominală/ frecvență a rețelei	Putere consumată (W)	EUR/buc.
655.104.00.1	[1]	16 / 20 / 25 / 32 / 40	230 V / 50/60 Hz	55	1334,32

Accesorii

Nou

Trusă pentru unealta de presare manuală



click & scan

Cod art.	Număr de tip	d, \varnothing [mm]	B [cm]	H [cm]	T [cm]	EUR/buc.
691.152.00.1	10-N	16 / 20 / 26	50,6	34,9	16	61,48

Livrabil din April 2024

Nou

Trusă Geberit FlowFit pentru unelte de prelucrare



click & scan

Cod art.	Număr de tip	B [cm]	H [cm]	T [cm]	EUR/buc.
691.161.00.1	10-P	50,6	34,9	16	61,04

Livrabil din April 2024



Nou

Trusă Geberit FlowFit pentru aparate de presare ACO 103 [1]



click & scan

Cod art.	Număr de tip	Compatibilitate	B [cm]	H [cm]	T [cm]	EUR/buc.
691.153.00.1	10-O	[1]	50,6	34,9	16	61,48

Livrabil din April 2024

Nou

Trusă Geberit FlowFit pentru aparate de presare ECO 203 și ACO 203 [2]



click & scan

Cod art.	Număr de tip	Compatibilitate	B [cm]	H [cm]	T [cm]	EUR/buc.
691.154.00.1	20-I	[2]	60,6	39,9	17,5	70,66

Livrabil din April 2024

Nou

Trusă Geberit FlowFit pentru aparate de presare EFP 203 [2]



click & scan

Cod art.	Număr de tip	Compatibilitate	B [cm]	H [cm]	T [cm]	EUR/buc.
691.155.00.1	20-J	[2]	60,6	39,9	17,5	70,66

Livrabil din April 2024

Nou

Fălci de presare Geberit FlowFit, în trusă



click & scan

Cod art.	Compatibilitate	d, ø [mm]	EUR/buc.
655.081.00.1	[1]	16 / 20 / 25 / 32 / 40	296,68
655.082.00.1	[2]	16 / 20 / 25 / 32 / 40	319,94

Livrabil din April 2024

Cod art.	Compatibilitate	d, ø [mm]	EUR/buc.
655.083.00.1	[2]	16 / 20 / 25 / 32 / 40 / 50 / 63 / 75	738,75

Livrabil din April 2024

Dispozitiv de colectare Geberit FlowFit pentru indicatoare de presare



click & scan

Cod art.		d, ø [mm]	EUR/buc.
690.940.00.1		16 / 20 / 25 / 32 / 40	8,25
690.941.00.1	N	50 / 63 / 75	9,42

N: Nou, livrabil din April 2024

Nou

Trusă Geberit FlowFit echipată cu adaptoare pentru sisteme terțe



click & scan

Cod art.	B [cm]	H [cm]	T [cm]	EUR/buc.
655.085.00.1	50,6	34,9	16	428,07

Livrabil din April 2024

Nou

Trusă Geberit FlowFit echipată cu unelte de debavurare și calibrare



click & scan

Cod art.	B [cm]	H [cm]	T [cm]	EUR/buc.
655.086.00.1	50,6	34,9	16	223,60

Livrabil din April 2024



Nou

Spray de detectare a scurgerilor Geberit



[click & scan](#)





Cod art.	Conținut [ml]	EUR/buc.
690.942.00.1	400	13,04

Livrabil din April 2024

Unelte pentru Geberit Mapress

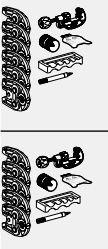

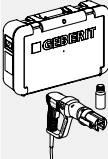
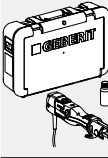
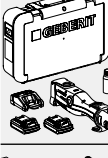

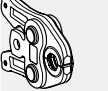
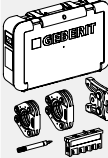
Privire de ansamblu asupra sortimentelor – Compatibilitate Geberit Mapress [1], [2], și [2XL]

Geberit România, Versiune: December 2023

	Cod art.	Dimensiune
Compatibilitate [1]		
 Aparat de presare Geberit ACO 103plus [1], în casetă	691.017.P1.1	
 Set fălci de presare Geberit Mapress [1]	690.190.00.1	12 mm 15 mm 18 mm 22 mm 28 mm 35 mm
	690.192.00.1	15 mm 18 mm 22 mm 28 mm 35 mm
 Fălci de presare Geberit Mapress [1]	690.121.00.1	12 mm
	690.122.00.1	15 mm
	690.123.00.1	18 mm
	690.124.00.1	22 mm
	690.125.00.1	28 mm
	690.126.00.1	35 mm
Compatibilitate [2]		
 Aparat de presare Geberit EFP 203 [2], în casetă	691.113.P2.1	
 Aparat de presare Geberit ECO 203 [2], în casetă	691.214.P2.1	
 Aparat de presare Geberit ACO 203plus [2], în casetă	691.218.P1.2	
 Set fălci de presare Geberit Mapress [2]	690.230.00.1	12 mm 15 mm 18 mm 22 mm 28 mm 35 mm
	690.232.00.1	15 mm 18 mm 22 mm 28 mm 35 mm
 Fălci de presare Geberit Mapress [2]	690.221.00.1	12 mm
	690.222.00.1	15 mm
	690.223.00.1	18 mm
	690.224.00.1	22 mm
	690.225.00.1	28 mm
	690.226.00.1	35 mm
 Coliere de presare Geberit Mapress [2], în casetă	691.296.00.2	42 mm 54 mm

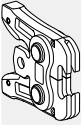
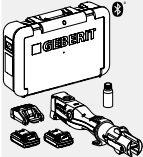
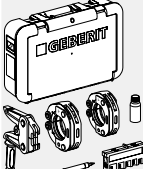
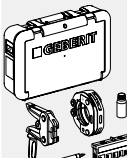

Geberit România, Versiune: December 2023

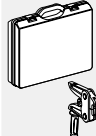
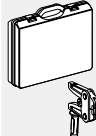
	Cod art.	Dimensiune
	691.181.00.1	35 mm
	691.182.00.1	42 mm
	691.183.00.1	54 mm
 Colier de presare Geberit Mapress [2] / [3]	691.185.00.3	66.7 mm
 Adaptor al colierului de presare Geberit ZB 203A [2]	691.203.00.1	35 mm 42 mm 50 mm 54 mm 63 mm 66.7 mm 75 mm
Compatibilitate [2XL]		
 Aparat de presare Geberit ACO 203XLplus [2] / [2XL], în casetă	691.229.P1.2	
 Coliere de presare Geberit Mapress [2XL], în casetă	691.188.00.1	76.1 mm 88.9 mm
 Colier de presare Geberit Mapress [2XL], în casetă	691.189.00.1	108 mm
 Colier de presare Geberit Mapress [2XL] / [3]	90797	76.1 mm
	90798	88.9 mm
	90799	108 mm
 Geberit Mapress ZB 221 adaptor al colierului de presare [2XL]	691.186.00.1	76.1 mm 88.9 mm 108 mm
 Geberit Mapress ZB 222 adaptor al colierului de presare [2XL]	691.187.00.1	108 mm

Vedere de ansamblu asupra sortimentului – Coliere de presare Geberit

Geberit România, Versiune: December 2023

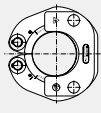
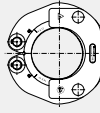
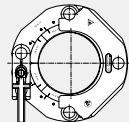
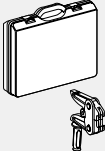
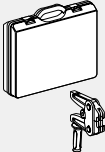
	Colier de presare, nou - d76,1	Colier de presare, nou - d88,9	Colier de presare, nou - d108
			
	90797	90798	90799
Compatibilitate [2XL] - nou			
691.186.00.1 Geberit Mapress ZB 221 adaptor al colierului de presare [2XL] 	✓	✓	✓
691.187.00.1 Geberit Mapress ZB 222 adaptor al colierului de presare [2XL] 			✓

✓ Compatibil

Compatibilitate unelte de presare [1]

Set fălci de presare Geberit Mapress [1]

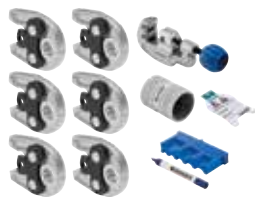

click & scan

Cod art.	Compatibilitate	d, ø [mm]	EUR/buc.
690.190.00.1	[1]	12 / 15 / 18 / 22 / 28 / 35	634,59
690.192.00.1	[1]	15 / 18 / 22 / 28 / 35	543,15



- Adecvat pentru trusa Geberit cu trusă modulară de la 10A-IV

Fălci de presare Geberit Mapress [1]



click & scan

Cod art.	Compatibilitate	d, ø [mm]	EUR/buc.
690.121.00.1	[1]	12	91,56
690.122.00.1	[1]	15	93,47
690.123.00.1	[1]	18	95,27
690.124.00.1	[1]	22	97,74
690.125.00.1	[1]	28	99,64
690.126.00.1	[1]	35	101,89

Accesorii

- Aparat de presare Geberit ACO 103plus [1], în trusă → p. 328



- Adecvat pentru trusa Geberit cu trusă modulară de la 10A-IV



Unelte

Unelte pentru Geberit Mapress
Compatibilitate unelte de presare [2]

Compatibilitate unelte de presare [2]

Set fălci de presare Geberit Mapress [2]

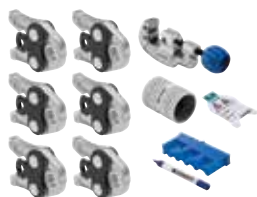

click & scan

Cod art.	Compatibilitate	d, ø [mm]	EUR/buc.
690.230.00.1	[2]	12 / 15 / 18 / 22 / 28 / 35	732,30
690.232.00.1	[2]	15 / 18 / 22 / 28 / 35	627,29

Accesorii

- Trusă Geberit pentru fălcile de presare [2], [3], cu inserție 10C-II → p. 320



- Adecvat pentru trusa Geberit cu trusă modulară de la 10C-II, 20A-V, 20B-IV, 20D-II
- Neadecvat pentru aparate de presare Geberit PWH 40

Fălci de presare Geberit Mapress [2]



click & scan

Cod art.	Compatibilitate	d, ø [mm]	EUR/buc.
690.221.00.1	[2]	12	105,03
690.222.00.1	[2]	15	107,50
690.223.00.1	[2]	18	109,97
690.224.00.1	[2]	22	112,32
690.225.00.1	[2]	28	114,90
690.226.00.1	[2]	35	117,27

Accesorii

- Trusă Geberit pentru fălcile de presare [2], [3], cu inserție 10C-II → p. 320



- Adecvat pentru trusa Geberit cu trusă modulară de la 10C-II, 20A-V, 20B-IV, 20D-II
- Neadecvat pentru aparate de presare Geberit PWH 40

Trusă Geberit pentru fălcile de presare [2], [3], cu inserție 10C-II



click & scan

Cod art.	Număr de tip	B [cm]	H [cm]	T [cm]	EUR/buc.
691.137.00.1	10C-II	52,4	38,3	17,4	45,79

Accesorii

- Curea de transport Geberit pentru trusă → p. 332

Coliere de presare Geberit Mapress [2], în trusă



click & scan

Cod art.	Compatibilitate	d, ø [mm]	EUR/buc.
691.296.00.2	[2]	42 / 54	1261,97

Accesorii

- Cureau de transport Geberit pentru trusă → p. 332



- Neadecvat pentru aparate de presare Geberit PWH 40

Colier de presare Geberit Mapress [2] / [3]



click & scan

Cod art.	Compatibilitate	d, ø [mm]	EUR/buc.
691.181.00.1	[2] / [3]	35	796,15
691.182.00.1	[2] / [3]	42	522,06
691.183.00.1	[2] / [3]	54	522,06
691.185.00.3	[2] / [3]	66,7	655,34

De comandat suplimentar

- Adaptor al colierului de presare Geberit ZB 203A [2] → p. 321



- Neadecvat pentru aparate de presare Geberit PWH 40

Adaptor al colierului de presare Geberit ZB 203A [2]



click & scan

Cod art.	Compatibilitate	d, ø [mm]	EUR/buc.
691.203.00.1	[2]	35 / 42 / 50 / 54 / 63 / 66,7 / 75	180,98



- Neadecvat pentru aparate de presare Geberit PWH 40



Unelte

Unelte pentru Geberit Mapress
Compatibilitate unelte de presare [2XL]

Compatibilitate unelte de presare [2XL]

Coliere de presare Geberit Mapress [2XL], în trusă



click & scan

Cod art.	Compatibilitate	d, ø [mm]	EUR/buc.
691.188.00.1	[2XL]	76,1 / 88,9	1715,57

Accesorii

- Curea de transport Geberit pentru trusă → p. 332

Colier de presare Geberit Mapress [2XL], în trusă



click & scan

Cod art.	Compatibilitate	d, ø [mm]	EUR/buc.
691.189.00.1	[2XL]	108	1443,17

De comandat suplimentar

- Geberit Mapress ZB 221 adaptor al colierului de presare [2XL] → p. 323

Accesorii

- Curea de transport Geberit pentru trusă → p. 332

Colier de presare Geberit Mapress [2XL] / [3]



click & scan

Cod art.	Compatibilitate	d, ø [mm]	EUR/buc.
90797	[2XL] / [3]	76,1	569,96
90798	[2XL] / [3]	88,9	644,12
90799	[2XL] / [3]	108	929,10

De comandat suplimentar

- Geberit Mapress ZB 221 adaptor al colierului de presare [2XL] → p. 323
- Geberit Mapress ZB 222 adaptor al colierului de presare [2XL] → p. 323

Geberit Mapress ZB 221 adaptor al colierului de presare [2XL]



click & scan

Cod art.	Compatibilitate	d, ø [mm]	EUR/buc.
691.186.00.1	[2XL]	76,1 / 88,9 / 108	392,47

Geberit Mapress ZB 222 adaptor al colierului de presare [2XL]



click & scan

Cod art.	Compatibilitate	d, ø [mm]	EUR/buc.
691.187.00.1	[2XL]	108	392,47

Compatibilitate unelte de presare [3]

Colier de presare Geberit Mapress [2] / [3]



click & scan

Cod art.	Compatibilitate	d, ø [mm]	EUR/buc.
691.181.00.1	[2] / [3]	35	796,15
691.182.00.1	[2] / [3]	42	522,06
691.183.00.1	[2] / [3]	54	522,06
691.185.00.3	[2] / [3]	66,7	655,34

De comandat suplimentar

- Adaptor al colierului de presare Geberit ZB 203A [2] → p. 321



- Neadecvat pentru aparate de presare Geberit PWH 40



Unelte

Unelte pentru Geberit Mapress
Unelte de prelucrare a țevilor

Colier de presare Geberit Mapress [2XL] / [3]



click & scan
EUR/buc.

Cod art.	Compatibilitate	d, ø [mm]	EUR/buc.
90797	[2XL] / [3]	76,1	569,96
90798	[2XL] / [3]	88,9	644,12
90799	[2XL] / [3]	108	929,10

De comandat suplimentar

- Geberit Mapress ZB 221 adaptor al colierului de presare [2XL] → p. 323
- Geberit Mapress ZB 222 adaptor al colierului de presare [2XL] → p. 323

Unelte de prelucrare a țevilor

Aparat de tăiat țevi Geberit Mapress R



click & scan
EUR/buc.

Cod art.	d, ø [mm]	Model	EUR/buc.
91087	12-35	35S	27,50
91088	12-54	65S	52,41

Set discuri de tăiere pentru aparat de tăiat țevi Geberit Mapress R



click & scan
EUR/buc.

Cod art.	d, ø [mm]	EUR/buc.
91092	12-54	18,63

Aparat de debavurat țevi Geberit Mapress



click & scan
EUR/buc.

Cod art.	d, ø [mm]	EUR/buc.
90363	12-54	29,53

Debavurator electric de țevi Geberit RE 1 Mapress, în trusă



click & scan

Cod art.	d, ø [mm]	Tensiune nominală/ frecvență a rețelei	Clasă de protecție	Putere consumată (W)	Greutate element principal	EUR/buc.
691.000.P2.3	15-108	230 V / 50 Hz	II	500	6,137	536,63

Accesorii

- Cureaua de transport Geberit pentru trusă → p. 332

Freză pentru debavurător electric de țevi Geberit Mapress RE 1



click & scan
EUR/buc.

Cod art.	d, ø [mm]	
90365	15-108	144,29

Ascuțitoare de țevă Geberit Mapress



click & scan
EUR/buc.

Cod art.	d, ø [mm]	
90372	15	30,31
90373	18	29,53
90374	22	29,53
90375	28	30,31

Ascuțitoare de țevă Geberit Mapress



click & scan
EUR/buc.

Cod art.	d, ø [mm]	
90376	35 / 42 / 54	31,21

Lamă pentru ascuțitoare de țevă Geberit Mapress



click & scan
EUR/buc.

Cod art.	d, ø [mm]	
90391	12 / 15 / 18	6,77
90394	22 / 28	6,77
90396	35 / 42 / 54	6,77

Șablon de adâncime Geberit Mapress, cu știft de marcare



click & scan
EUR/buc.

Cod art.	d, ø [mm]	
90351	12-108	5,62



Unelte

Unelte pentru Geberit Mapress
Dopuri de etanșare

Știft de marcare Geberit Mapress



click & scan

Cod art.	Tip	EUR/buc.
90358	Rotunjit	2,82

Dispozitiv auxiliar de montaj Geberit Mapress MH 1



click & scan

Cod art.	d, ø [mm]	EUR/buc.
90563	54-108	198,70

Dopuri de etanșare

Dop de etanșare Geberit Mapress pentru capete de țevă cu fitting



click & scan

Cod art.	d, ø [mm]	EUR/buc.
90922	15	33,90
90923	18	33,90
90924	22	34,90
90925	28	43,99
90926	35	45,79
90927	42	62,40
90928	54	78,00
90929	76,1	156,64
90930	88,9	220,82
90931	108	425,91

Etanșare pentru dopuri de etanșare Geberit Mapress



click & scan

Cod art.	d, ø [mm]	EUR/buc.
90341	15	2,82
90342	18	2,82
90343	22	2,82

Set de etanșare pentru dopuri de etanșare Geberit Mapress



click & scan
EUR/buc.

Cod art.	d, ø [mm]	EUR/buc.
90344	28	4,56
90345	35	4,56
90346	42	4,62
90347	54	5,62
90348	76,1	11,00
90349	88,9	22,57
90350	108	31,21

Accesorii

Nou

Spray de detectare a scurgerilor Geberit



click & scan

Cod art.	Conținut [ml]	EUR/buc.
690.942.00.1	400	13,04

Livrabil din April 2024

Nou

Kroon-Oil®



click & scan

Cod art.	Conținut [ml]	EUR/buc.
691.106.00.1	120	12,30

Livrabil din March 2024



- Produs înlocuitor pentru cod art. 90000



Aparate de presare

Compatibilitate aparate de presare [1]

Aparat de presare Geberit ACO 103plus [1], în trusă



click & scan

Cod art.	Compatibilitate	Tensiune nominală/frecvență a rețelei	Clasă de protecție	Putere consumată (W)	Greutate element principal	EUR/buc.
Valabil pentru sistem: Geberit Mapress / Geberit Mepla						
691.017.P1.1	[1]	230 V / 50-60 Hz	III	55	6,78	1015,36

Accesorii

- Curea de transport Geberit pentru trusă → p. 332

Aparat de presare Geberit ACO 103plus [1]



click & scan

Cod art.	Compatibilitate	Tensiune nominală/frecvență a rețelei	Clasă de protecție	Putere consumată (W)	Greutate element principal	EUR/buc.
690.017.00.1	[1]	12 V DC	III	240	1,625	729,05

De comandat suplimentar

- Acumulator Geberit Li-Ion 12 V → p. 328
- Încărcător de acumulator Geberit, 12 V → p. 328



- Adecvat pentru trusa Geberit cu trusă modulară de la 10A-I

Acumulator Geberit Li-Ion 12 V



click & scan

Cod art.	Tensiune nominală/frecvență a rețelei	Capacitate acumulator [Ah]	EUR/buc.
690.019.00.1	12 V DC	2	63,78

Încărcător de acumulator Geberit, 12 V



click & scan

Cod art.	Tensiune nominală/frecvență a rețelei	Putere consumată (W)	Durată de încărcare a acumulatorului [min]	EUR/buc.
242.614.P1.1	220-240 V / 50/60 Hz	55	30	112,89

Compatibilitate aparate de presare [2]

Aparat de presare Geberit ACO 203plus [2], în trusă



click & scan

Cod art.	Compatibilitate	Tensiune nominală/frecvență a rețelei	Clasă de protecție	Putere consumată (W)	Greutate element principal	EUR/buc.
Valabil pentru sistem: Geberit Mapress / Geberit Mepia						
691.218.P1.2	[2]	230 V / 50–60 Hz	III	90	8,97	1387,17

Accesorii

- Cureauă de transport Geberit pentru trusă → p. 332
- Acumulator Geberit Li-Ion 18 V → p. 329

Aparat de presare Geberit ACO 203plus [2]



click & scan

Cod art.	Compatibilitate	Tensiune nominală/frecvență a rețelei	Clasă de protecție	Putere consumată (W)	Greutate element principal	EUR/buc.
690.512.00.2	[2]	18 V DC	III	450	3,7	934,92

De comandat suplimentar

- Acumulator Geberit Li-Ion 18 V → p. 329



- Adecvat pentru trusa Geberit cu trusă modulară de la 20A-II

Acumulator Geberit Li-Ion 18 V



click & scan

Cod art.	Tensiune nominală/frecvență a rețelei	Capacitate acumulator [Ah]	EUR/buc.
690.600.00.1	18 V DC	5	147,65

Încărcător de baterii Geberit 12/18 V



click & scan

Cod art.	Tensiune nominală/frecvență a rețelei	Putere consumată (W)	Durată de încărcare a acumulatorului [min]	EUR/buc.
690.598.P1.2	110–240 V / 50/60 Hz	90	40–75	126,97



Aparat de presare Geberit ECO 203 [2], în trusă



click & scan

Cod art. Compatibilitate Tensiune nominală/frecvență a rețelei Clasă de protecție Putere consumată (W) Greutate element principal EUR/buc.

Valabil pentru sistem: Geberit Mapress / Geberit Mepla

691.214.P2.1	[2]	230 V / 50-60 Hz	II	450	8,64	1078,31
--------------	-----	------------------	----	-----	------	---------

Accesorii

- Cureaua de transport Geberit pentru trusă → p. 332

Aparat de presare Geberit ECO 203 [2]



click & scan

Cod art. Compatibilitate Tensiune nominală/frecvență a rețelei Clasă de protecție Putere consumată (W) Greutate element principal EUR/buc.

690.511.P2.1	[2]	230 V / 50-60 Hz	II	450	4,055	991,02
--------------	-----	------------------	----	-----	-------	--------



- Adecvat pentru trusa Geberit cu trusă modulară de la 20B-II

Aparat de presare Geberit EFP 203 [2], în trusă



click & scan

Cod art. Compa- d, ø Tensiune nominală/frecvență a rețelei Clasă de protecție Putere consumată (W) Greutate element principal EUR/buc.

tibilitate [mm]

Valabil pentru sistem: Geberit Mapress / Geberit Mepla

691.113.P2.1	[2]	28	230 V / 50-60 Hz	II	450	8,17	995,96
--------------	-----	----	------------------	----	-----	------	--------

Accesorii

- Cureaua de transport Geberit pentru trusă → p. 332

Aparat de presare Geberit EFP 203 [2]



click & scan

Cod art. Compatibilitate Tensiune nominală/frecvență a rețelei Clasă de protecție Putere consumată (W) Greutate element principal EUR/buc.

691.103.P2.1	[2]		230 V / 50-60 Hz	II	450	4,149	934,03
--------------	-----	--	------------------	----	-----	-------	--------



- Adecvat pentru trusa Geberit cu trusă modulară de la 20B-II

Compatibilitate aparate de presare [2XL]

Aparat de presare Geberit ACO 203XLplus [2] / [2XL], în trusă



click & scan

Cod art.	Compatibilitate	Tensiune nominală/frecvență a rețelei	Clasă de protecție	Putere consumată (W)	Greutate element principal	EUR/buc.
Valabil pentru sistem: Geberit Mapress / Geberit Mepia						
691.229.P1.2	[2] / [2XL]	230 V / 50–60 Hz	III	90	10,738	1573,30

Accesorii

- Cureaua de transport Geberit pentru trusă → p. 332

Aparat de presare Geberit ACO 203XLplus [2] / [2XL]



click & scan

Cod art.	Compatibilitate	Tensiune nominală/frecvență a rețelei	Clasă de protecție	Putere consumată (W)	Greutate element principal	EUR/buc.
690.514.00.2	[2] / [2XL]	18 V DC	III	450	4,559	1391,34

De comandat suplimentar

- Acumulator Geberit Li-Ion 18 V → p. 329



- Adecvat pentru trusa Geberit cu trusă modulară de la 20D

Acumulator Geberit Li-Ion 18 V



click & scan

Cod art.	Tensiune nominală/frecvență a rețelei	Capacitate acumulator [Ah]	EUR/buc.
690.600.00.1	18 V DC	5	147,65

Încărcător de baterii Geberit 12/18 V



click & scan

Cod art.	Tensiune nominală/frecvență a rețelei	Putere consumată (W)	Durată de încărcare a acumulatorului [min]	EUR/buc.
690.598.P1.2	110–240 V / 50/60 Hz	90	40–75	126,97



Trusă universală

Trusă universală

Trusă universală Geberit, cu trei compartimente



click & scan

Cod art.	B [cm]	H [cm]	T [cm]	EUR/buc.
691.141.00.1	50,6	34,9	16	43,05

Accesorii

- Cureaua de transport Geberit pentru trusă → p. 332

Cureaua de transport Geberit pentru trusă



click & scan

Cod art.	EUR/buc.
691.129.00.1	11,00



Anexe

Abreviere.....	336
Condiții generale privind vânzările și livrarea de bunuri	337
Index	341



Abreviere

Abreviere	Descriere
DN	OD / Diametru nominal
di, \emptyset	Diametru interior (mm)
da	Diametru exterior al țevii (mm)
d3, \emptyset	Diametru exterior (mm)
E1	Adâncime de inserție (cm)
E	Adâncime de inserție (cm)
di1, \emptyset	Diametru interior (mm)
DN	Diametru nominal
d2, \emptyset	Diametru exterior (mm)
D1	Diametru exterior (cm)
d1, \emptyset	Diametru exterior (mm)
B4	Lățime (cm)
B3	Lățime (cm)
B2	Lățime (cm)
b	Dimensiune parțială (cm)
B	Lățime (cm)
D	Diametru exterior (cm)
d, \emptyset	Diametru exterior (mm)
c	Diametrul orificiului flanșei (mm)
B1	Lățime (cm)
arc	Unghi (°)
DN1	Diametru nominal
Z2	Dimensiune Z (cm)
Z3	Dimensiune Z (cm)
Z4	Dimensiune Z (cm)
Z5	Dimensiune Z (cm)
K1	Scurtare maximă (cm)
K	Scurtare maximă (cm)
X6	Lungimea laturii / Dimensiune L (cm)
Z	Dimensiune Z (cm)
Z1	Dimensiune Z (cm)
KL	Lungimea cablului (cm)
K3	Scurtare maximă (cm)
K2	Scurtare maximă (cm)
Z6	Dimensiune Z (cm)
L1	Lungime (cm)
L	Lungime (m)
l	Lungime dimensiune parțială (cm)
V	Domeniu de măsurare a debitului volumetric (l)
L	Lungime (cm)
H3	Înălțime (cm)
X	Lungimea laturii / Dimensiune L (cm)
H2	Înălțime (cm)
X1	Lungimea laturii / Dimensiune L (cm)
T1	Adâncime (cm)
G2	Filet de țevă (")
T2	Adâncime (cm)
h1	Înălțime dimensiune parțială (cm)
T3	Adâncime (cm)
H1	Înălțime (cm)
h	Înălțime dimensiune parțială (cm)
H	Înălțime (cm)
k	Diametrul cercului centrelor găurilor la flanșă (mm)
X2	Lungimea laturii / Dimensiune L (cm)

Abreviere	Descriere
X3	Lungimea laturii / Dimensiune L (cm)
h3	Înălțime dimensiune parțială (cm)
X4	Lungimea laturii / Dimensiune L (cm)
h2	Înălțime dimensiune parțială (cm)
X5	Lungimea laturii / Dimensiune L (cm)
Ks	Scurtare maximă la sudarea cap la cap (cm)
G1	Filet de țevă (")
G	Filet de țevă (")
T5	Adâncime (cm)
T4	Adâncime (cm)
UNC	Filet în inch
n	Număr de șuruburi pentru conexiunea cu flanșă (buc.)
PN	Presiune nominală (bar)
r	Rază (cm)
R	Filet exterior conic (")
Ks6	Scurtare maximă la sudarea cap la cap (cm)
Ks5	Scurtare maximă la sudarea cap la cap (cm)
Ks4	Scurtare maximă la sudarea cap la cap (cm)
Ks3	Scurtare maximă la sudarea cap la cap (cm)
Ks2	Scurtare maximă la sudarea cap la cap (cm)
Ks1	Scurtare maximă la sudarea cap la cap (cm)
s ISO	Grosimea peretelui (pentru etichete) (mm)
AD1	Distanță de racordare (cm)
L2	Lungime dimensiune parțială (cm)
L2	Lungime (cm)
l1	Lungime dimensiune parțială (cm)
La	Extensie pe lungime (mm)
l3	Lungime dimensiune parțială (cm)
L3	Lungime (cm)
m	Diametrul orificiului de înșurubare (mm)
M	Filet metric (mm)
IK	Lungime de prindere a șurubului (cm)
B5	Lățime (cm)
B6	Lățime (cm)
AB	Zona de racordare (mm)
a1	Dimensiune parțială (cm)
AD	Distanță de racordare (cm)
A ²	Secțiune transversală internă (cm ²)
AB2	Zonă de racordare (mm)
AB1	Zonă de racordare (mm)
a	Dimensiune parțială (cm)
A	Proeminență (cm)
T	Adâncime (cm)
A1	Proeminență (cm)
R1	Filet exterior conic (")
Rp2	Filet interior de țevă conic (")
Rp1	Filet interior de țevă conic (")
Rp	Filet interior de țevă conic (")
Rg	Filet rotund (")
s1	Grosimea peretelui (mm)
s	Grosimea peretelui (mm)
S	Serie țevi
SW	Deschiderea cheii (mm)

Condiții generale privind vânzările și livrarea de bunuri

(valabile de la 1 aprilie 2024)

1. Informații generale

- 1.1 Toate vânzările, livrările și serviciile companiei Geberit SRL (denumită în continuare „Geberit”) sunt efectuate exclusiv în baza următoarelor Condiții generale privind vânzările și livrarea de bunuri. Prin prezenta, condițiile generale ale cumpărătorului (în cazul în care acestea există) nu se vor aplica în relația dintre părți. Aceste Condiții privind vânzările și livrarea de bunuri sunt considerate ca fiind acceptate de către cumpărător cel mai târziu o dată cu acceptarea bunurilor livrate.
- 1.2 Toate contractele, comenzile și acordurile – în special cele menite să schimbe condițiile stabilite prin acest document – vor deveni valide numai cu acordul scris al Geberit.

2. Oferte, comenzi, acorduri – Formă scrisă

- 2.1 Ofertele Geberit au caracter obligatoriu, doar dacă acest lucru a fost convenit în scris.
- 2.2 Comanda este considerată ca fiind acceptată de către Geberit numai în momentul în care aceasta a fost confirmată în scris și o confirmare a comenzii a fost trimisă cumpărătorului.
- 2.3 Toate acordurile, declarațiile și alte informații trebuie să existe în formă scrisă pentru a dobândi valabilitate.

3. Condiții de livrare – Transferul riscurilor

- 3.1 Livrarea bunurilor va fi efectuată în sistemul „Delivery At Place”, (DAP – INCOTERMS 2010) dacă în confirmarea comenzii nu este menționată și convenită o altă condiție de livrare.
- 3.2 Prețurile din facturile Geberit vor fi prețuri nete. În cazul în care livrările sunt în afara spațiului intracomunitar, prețurile din facturile Geberit nu vor include eventualele taxe sau taxe vamale. În cazul livrarilor în afara spațiului intracomunitar, cumpărătorul este responsabil de toate taxele de import și orice alte taxe locale, precum și de cheltuielile de transport, manipulare și descărcare a bunurilor.
- 3.3 Cumpărătorul este obligat să furnizeze la timp companiei Geberit toate informațiile necesare pentru ca Geberit să-și îndeplinească obligațiile referitoare la taxe și costuri vamale, în cazul în care acestea sunt necesare. În special, cumpărătorul este obligat să furnizeze companiei Geberit o documentație de export autorizată (de ex. certificatul de export în original) și/sau nr. de identificare TVA. În cazul în care cumpărătorul nu-și îndeplinește obligațiile de a furniza companiei Geberit toate informațiile necesare, cumpărătorul va fi răspunzător pentru toate reclamațiile înaintate și pentru daunele cauzate companiei Geberit ca urmare a acestei situații, în special cu referire la taxe (TVA, GST, taxa pt bunuri și servicii, taxa pe vânzări sau orice alte taxe similare care depind de cifra de afaceri), taxa vamală, dobânzi, costuri administrative (de ex. cheltuieli juridice și de consultanță) și penalizări. Atunci când este necesar, cumpărătorul trebuie să obțină pe riscul și cheltuiala sa orice licență pentru import, orice alte autorizații oficiale și să întocmească formalitățile vamale necesare la importul mărfurilor.
- 3.4 Riscul pierderilor – inclusiv pierderi survenite prin accident – sau deteriorarea accidentală a bunurilor este transferat către cumpărător în momentul în care bunurile ajung la locul convenit, dacă nu este stipulat altfel în confirmarea comenzii aferente.

4. Data de livrare. Întârzieri la livrare, Livrare parțială.

- 4.1 Data de livrare specificată în confirmările de comandă nu are caracter obligatoriu, ci informativ.
- 4.2 În cazul apariției unor evenimente neprevăzute sau inevitabile (forță majoră) și în cazul blocajelor operaționale de orice fel, în special defecțiuni ale utilajelor, greve sau conflicte de muncă, întârzierea furnizării materialelor prime importante către fabricile Geberit sau a unor măsuri administrative, Geberit este îndreptățită la retragerea articolelor afectate din contractul de vânzare, fie în întregime fie parțial, sau să prelungească termenul de livrare în consecință, luând în considerare o perioadă de relansare în producție a articolelor respective. Geberit va informa în scris cumpărătorul despre orice astfel de eveniment.
- 4.3 În cazul unei întârzieri la livrare, după expirarea unui termen final de livrare agreeat în scris, cumpărătorul, poate să se retragă din contract. În cazul în care onorarea comenzii este imposibilă, cumpărătorul beneficiază de acest drept chiar și fără stabilirea unui termen final de livrare. Toate reclamațiile cumpărătorului cu privire la despăgubiri pentru daunele rezultate din întârzierea livrării, incluzând dar nelimitându-se la daune indirecte, - cu excepția prevederilor incluse în secțiunea
- 4.4 precum și solicitarea cumpărătorului privind rambursarea eventualelor cheltuieli sunt excluse.
- 4.5 Excluderea răspunderii reglementată în secțiunea 4.3 nu se aplică în cazul daunelor provocate cu intenție sau din neglijență gravă de către Geberit. În alte cazuri, conform legislației cu caracter imperativ, răspunderea Geberit este limitată la daunele tipice contractuale, previzibile, care nu depășesc valoarea comenzii respective.
- 4.6 Geberit își rezervă dreptul de a efectua livrări parțiale, în cazul în care părțile nu au convenit în scris contrariul.

5. Prețuri. Plăți. Defecte.

- 5.1 Prețurile practice de Geberit sunt bazate pe listele de prețuri valabile la data confirmării comenzii.
- 5.2 Bunurile trebuie plătite conform termenelor de plată agreeate prin condițiile comerciale. Pentru orice excepție de la termenul agreeat, clientul trebuie să primească acceptul scris al Geberit.
- 5.3 Dacă termenul de plată este depășit, se va calcula o dobândă la ratele practicate de către băncile comerciale, care nu va fi mai mică de 6 % p.a.
- 5.4 Plata prin instrumente de plată nu este acceptată de către Geberit. Orice excepție necesită încheierea unui acord scris între părți, în acest sens. Plata efectuată prin instrumente de plată nu constituie onorarea completă a plății până ce respectiva sumă a fost în mod irevocabil creditată în contul bancar al Geberit. Taxele și cheltuielile aferente operării instrumentelor de plată vor fi suportate exclusiv de către cumpărător.
- 5.5 În caz de neplată, de insolvență a cumpărătorului sau în cazul în care datoriile sunt puse în pericol prin insolvabilitatea acestuia, Geberit va avea dreptul să ceară achitarea imediată a tuturor datoriilor scadente la termen și pe a celor neajunse la scadență, sau furnizarea unor garanții. Geberit va avea de asemenea dreptul de a efectua livrări restante numai dacă acestea sunt achitate în avans sau au fost furnizate în prealabil suficiente garanții. Dacă acest lucru nu poate fi stabilit de către cumpărător într-o perioadă rezonabilă de timp, Geberit se poate retrage din contractul de vânzare.



6. Ambalajul

Cu excepția cazului în care există alte prevederi, bunurile vor fi livrate în ambalajul standard. Cumpărătorul va plăti pentru orice ambalaj special solicitat.

7. Bunuri defecte. Garanția

- 7.1 Cumpărătorul trebuie să verifice toate bunurile în momentul preluării acestora. Toate viciile aparente, vizibile în cursul unei examinări obișnuite, trebuie raportate în scris către Geberit în termen de opt (8) zile de la data preluării. În caz contrar, se consideră că bunurile achiziționate sunt acceptate și se exclude astfel posibilitatea înaintării unor cereri pentru acordarea de despăgubiri.
- 7.2 În măsura în care există defecte care nu au fost remarcate în cursul examinării obișnuite, imediat după descoperirea acestor defecte, trebuie înaintată o notificare în acest sens. În caz contrar, se consideră că bunurile achiziționate sunt acceptate și se exclude astfel posibilitatea înaintării unor cereri pentru acordarea de despăgubiri.
- 7.3 Cumpărătorul se obligă să pună bunurile care prezintă defecte la dispoziția Geberit într-o perioadă rezonabilă de timp, imediat după descoperirea defectului, în stare nealterată, astfel încât defectul să poată fi verificat. Totuși, această obligație nu îl exonerează pe cumpărător de obligația de a face dovada prezenței unui defect.
- 7.4 Geberit își rezervă dreptul de a repara bunurile defecte sau de a le înlocui fără alte costuri, numai dacă se demonstrează că bunurile sunt defecte, iar acestea au fost depozitate, păstrate, instalate și utilizate corespunzător și cu profesionalism de către cumpărător și cumpărătorul a notificat defectele conform prevederilor convenite mai sus. În cazul în care niciuna din aceste condiții nu se dovedește a fi respectată, Geberit este îndreptățit la refuzarea cererilor pentru acordarea unor despăgubiri. Geberit beneficiază de asemenea de dreptul de a refuza îndeplinirea ulterioară a obligațiilor sale, atâta vreme cât cumpărătorul nu se achită de obligațiile sale de plată.
- 7.5 În cazul în care soluțiile conforme cu prevederile secțiunii 7.4 sunt respinse de către Geberit sau nu au constituit un succes, cumpărătorul are posibilitatea fie de a solicita o reducere a prețului de achiziție (reducere de preț), fie de a se retrage din contract, conform reglementărilor legale în vigoare (retragere).
- 7.6 Cererile de acordare de despăgubiri pentru defecte au o perioadă de limitare de un (1) an după data facturării.
- 7.7 Compensațiile sunt condiționate de îndeplinirea premergătoare de către cumpărător a obligațiilor care îi revin.
- 7.8 Orice tip de solicitare bazată pe defecte ale bunurilor sunt supuse limitării răspunderii numite în secțiunea 8.
- 7.9 Prevederile de mai sus se aplică în mod corespunzător și dacă în locul cantităților sau bunurilor convenite sunt livrate cantități mici sau alte bunuri.

8. Răspunderea Geberit

- 8.1 Cu excepția cazului în care există prevederi contrare, orice pretenții ale cumpărătorului adresate către Geberit din orice motiv legal, în special pretențiile solicitate pentru încălcarea obligațiilor contractuale principale și subsidiare, precum rambursarea cheltuielilor sau acordarea de despăgubiri sunt excluse. Acest lucru presupune în principal excluderea: pretențiilor pentru daune-interese altele în afara de cele aferente bunurilor achiziționate, pretențiilor pentru pierderi de profit, pretențiilor care nu rezultă din defecte de fabricație ale bunurilor livrate.
- 8.2 Exonerarea de răspundere menționată în secțiunea 8.1. nu se aplică în cazul daunelor care rezultă din vătămarea din culpa, cu intenție directă sau din neglijență gravă, a integrității corporale, a sănătății și a vieții persoanei. De asemenea, exonerarea de răspundere nu se aplică în cazul în care există o răspundere obligatorie în conformitate cu prevederile legale privind răspunderea pentru produsele furnizate pentru uz privat.
- 8.3 Supusă legilor cu caracter imperativ în alte cazuri decât se precizează în secțiunea 8.2, răspunderea Geberit este limitată la daunele contractuale previzibile, care nu depășesc suma comenzii respective.

- 8.4 În măsura în care răspunderea este exclusă sau limitată în cazul Geberit, acest lucru se aplică tuturor reprezentanților săi, angajaților, subcontractorilor și agenților comerciali.

9. Retenția de drepturi. Garanții.

- 9.1 Geberit își va păstra dreptul de proprietate asupra bunurilor furnizate, până ce plata prețului de achiziție corespunzător și achitarea datoriilor restante de către cumpărător în contul Geberit au fost efectuate (bunuri denumite în continuare „Bunuri Reținute”). Cumpărătorul va lua toate măsurile necesare pentru protecția drepturilor de proprietate ale Geberit.
- 9.2 Cumpărătorul va prelucra Bunurile Reținute pentru Geberit, acționând ca și producător, fără nicio obligație din partea Geberit. Bunurile prelucrate vor fi în continuare considerate Bunuri Reținute.
- 9.3 În cazul în care cumpărătorul prelucrează, combină și amestecă Bunurile Reținute cu alte produse, Geberit va deveni coproprietar al noului produs în proporția valorii de facturare a Bunurilor Reținute, față de valoarea de facturare a celorlalte bunuri folosite. În cazul în care dreptul de proprietate al Geberit încetează ca urmare a combinării sau amestecului, cumpărătorul se angajează să transfere dreptul său de proprietate asupra noului produs la suma valorii de facturare a Bunurilor Reținute către Geberit. Dreptul parțial de proprietate al lui Geberit va fi considerat Bunuri Reținute.
- 9.4 Cumpărătorul are dreptul de a revinde Bunurile Reținute în mersul firesc al afacerii și în conformitate cu termenii și condițiile obișnuite.
- 9.5 În momentul agreeerii „Condițiilor comerciale client” cu Geberit, cumpărătorul cedează Geberit toate drepturile care se bazează / se vor baza pe revânzarea Bunurilor Reținute. Drepturile astfel cedate vor fi considerate drept garanție pentru Bunurile Reținute. Cumpărătorul nu va avea dreptul de a ceda altfel aceste drepturi. Atâta vreme cât a fost convenită o relație contractuală continuă între cumpărător și clienții săi, cedarea se referă la soldul din acel moment. Cumpărătorul va beneficia în continuare de dreptul de a colecta aceste drepturi cedate de la clienți sau terți chiar și după ce acestea au fost cedate; dreptul Geberit de a colecta datoriile rămase nu este afectat de acest lucru. Geberit are dreptul de a solicita cumpărătorului să informeze Geberit în legătură cu drepturile cedate și debitorii săi, să ofere în scris către Geberit toate informațiile care sunt necesare pentru colectare, să predea către Geberit toate documentele relevante și să informeze în scris debitorii cu privire la cedarea datoriilor. Totuși, Geberit nu se angajează să colecteze datoriile sau să solicite informațiile de mai sus, atâta vreme cât cazurile menționate în secțiunea 5.5 nu au loc.
- 9.6 În cazurile specificate în secțiunea 5.5 și în cazul în care cumpărătorul nu își îndeplinește obligațiile de la secțiunile 9.3 și 9.5, Geberit va avea de asemenea dreptul de a interzice prelucrarea și revânzarea cu efect imediat a Bunurilor Reținute. O declarație de retragere din contract din partea Geberit este de asemenea considerată a fi o retragere a autorizației de a revinde și de a colecta plățile. În acest caz, Geberit va beneficia de dreptul de a solicita returnarea imediată a Bunurilor Reținute, costurile fiind suportate de către cumpărător și cu excluderea dreptului de retenție. În cazurile de mai sus, cumpărătorul autorizează Geberit sau pe agenții acestuia care prezintă o împuternicire scrisă pentru a intra în incinta societății sale pe jos sau în vehicule pentru a redobândi Bunurile Reținute.
- 9.7 În măsura în care retenția titlurilor nu poate fi convenită cu cumpărătorul în conformitate cu prevederile legale în vigoare, un drept de retenție asupra bunurilor sau asupra bunurilor prelucrate sau asupra prețului de cumpărare al cumpărătorului care rezultă din revânzarea acestor bunuri va fi de asemenea convenit. Un drept de retenție presupune că bunurile servesc drept garanție pentru Geberit până la achitarea completă a prețului de cumpărare, până în acel moment cumpărătorul fiind îndreptățit să prelucreze sau să revândă bunurile numai cu acordul Geberit.
- 9.8 Dacă valoarea garanțiilor către Geberit depășește datoriile care trebuie garantate cu mai mult de 20%, Geberit se obligă, la solicitarea cumpărătorului, să elibereze garanțiile la alegerea Geberit, care depășesc pragul mai sus menționat.

10. Re-exportul

10.1 Geberit atrage în mod explicit atenția asupra faptului că în alte țări produsele Geberit sunt protejate prin numeroase drepturi de proprietate intelectuală. Cumpărătorul este obligat, așadar, la solicitarea de consultanță din partea Geberit înainte de a-și planifica un export. 10.2. Livrarea de bunuri și de documentație a oricărui produs, incluzând nu numai ghidurile de prezentare a produsului, ci și instrucțiunile de instalare, către SUA sau Canada este interzisă și necesită acordul scris al Geberit.

11. Interzicerea cesionării și compensării

11.1 Cumpărătorul va beneficia de dreptul de a cesiona drepturile și obligațiile care derivă din contractele de vânzare către terți numai cu acordul prealabil al Geberit. 11.2. Cumpărătorul nu are dreptul de a compensa pretenții împotriva prețului de cumpărare, decât în cazul unei cereri vădit legitime, nedisputabile, conformă cu legislația în vigoare.

11.2 Cumpărătorul nu are dreptul de a compensa prețul de cumpărare în baza unor acțiuni care nu rezultă din contractul de vânzare în cauză.

12. Locul achitării obligațiilor. Jurisdicția și Legea aplicabilă

12.1 Locul în care vor fi îndeplinite toate obligațiile rezultând din contractul de vânzare va fi sediul Geberit din București, România.

12.2 Locul de soluționare a litigiilor care rezultă din contractul de vânzare va fi instanța arondată sediului Geberit din București, România. Opțional, Geberit poate iniția o acțiune judecătorească în cadrul instanței responsabile pentru sediul comercial al cumpărătorului.

12.3 Contractul de vânzare se supune legilor române. Aplicarea Convenției Națiunilor Unite pentru Vânzarea Internațională de Bunuri („Convenția de la Viena privind vânzarea de bunuri”) este exclusă în mod expres.

13. Garanție

13.1 Pe lângă garanția specificată în secțiunea 8, Geberit garantează pentru produsele și perioadele enumerate mai jos, că bunurile livrate nu prezintă niciun defect material sau de producție.

Perioada de garanție de la data livrării către cumpărător:

Tevi si fitting-uri HDPE	10 ani
Geberit Pluvia	10 ani
Tevi si fittinguri Silent-db20	10 ani
Tevi si fittinguri Silent-PP	10 ani
Tevi si fitting-uri Mepla	10 ani
Tevi si fitting-uri FlowFit	10 ani
Tevi si fitting-uri Mapress	10 ani
Truse	2 ani
Rezervoare ingropate Geberit si elemente de instalare	10 ani
Geberit Monolith	10 ani
Componentele electronice ale Geberit Monolith Plus	2 ani
Sifoane de scurgere Geberit	10 ani
Rezervoare aparente AP123 si 128	10 ani
Rezervoare aparente AP110, 116 și 117	5 ani
Mecanisme universale Impuls 590, 360, 380, 280	5 ani
Mecanisme universale ImpulsBasic 330, 340, 230	2 ani
Clapete de actionare mecanice	5 ani
Clapete de actionare pneumatice	2 ani
Baterii electronice si pneumatice lavoar	2 ani
Geberit AquaClean	2 ani
Actionari electronice pentru pisoar și WC	2 ani
Obiecte sanitare ceramice Geberit*	10 ani
Obiecte sanitare ceramice Kolo	7 ani

Capace si colace WC	2 ani
Produce din acril	7 ani
Mobilier si oglinzi pentru baie	2 ani
Cabine de dus	2 ani
Accesorii	2 ani

* Glazura KeraTect® a produselor ceramice Geberit are garanție 30 ani.

13.2 Perioadele de garanție vor începe de la data livrării către cumpărător. Dacă pe durata perioadei de garanție apar defecțiuni materiale sau de producție, Geberit își va îndeplini obligațiile reparând bunurile defecte sau înlocuindu-le gratuit. Orice alte revendicări împotriva Geberit pe baza acestei garanții adiționale vor fi în mod expres excluse, dacă este posibil conform legii aplicabile.

La expirarea perioadei de garanție toate revendicările de garanție, în special acelea care privesc bunurile care au fost reparate sau înlocuite pe perioada garanției, vor fi excluse.

13.3 Garanția este valabilă numai în următoarele condiții:

- instalarea se efectuează în conformitate cu manualele tehnice și instrucțiunile Geberit

și

- bunurile au fost depozitate, instalate, păstrate și utilizate în mod profesional și corect și
- bunurile nu au fost modificate, mai ales nu au fost înlăturate, schimbate sau adăugate părțile componente

și

- sistemele sunt construite numai cu componente originale Geberit

13.4 Garanția pentru funcționarea sistemului sifonic de scurgere Geberit Pluvia pentru acoperișuri este valabilă numai în următoarele condiții adiționale (secțiunii 13.3):

Sistemul Geberit Pluvia este calculat de personalul Geberit pregătit corespunzător folosind programele soft originale Geberit Pluvia;

și

- executia instalatiei Pluvia corespunde tuturor datelor geometrice rezultate din calcul;

și

- sistemul este construit numai cu componente originale Geberit (receptori, țevi, fittinguri, armături și sisteme de fixare);

și

- sistemul este instalat de către persoane instruite în mod corespunzător de către Geberit, care dețin un certificat în acest sens;

și

- instalarea se efectuează în conformitate cu regulile scrise din manualul tehnic Geberit;

și

- sistemul este testat în conformitate cu regulile și reglementările locale;

și

- dimensiunile sistemului instalat sunt verificate și comparate cu calculele / modelul inițial;

și

- acoperișul este construit în conformitate cu reglementările locale privind construcțiile;

și

- acoperișul trebuie să fie echipat cu țevi de evacuare prevazute pentru a preîntâmpina volumele de apă în exces (overflow direct sau prea-plin);

și

- calcularea statică a structurii acoperișului include o încărcătură maximă de apă, până la nivelul de prea-plin;

și

- calcularea acoperișului este bazată pe standardele locale, intensitatea și tipul precipitațiilor;

și

- scurgerea fără obstacole către receptorii de evacuare de pe



acoperiș este verificată în mod regulat, cel puțin o dată pe lună și după fiecare cădere intensivă de ploaie sau cădere masivă de zăpadă. Dacă sistemul Pluvia, instalat corect, nu funcționează și toate condițiile de mai sus sunt îndeplinite, Geberit se va achita de obligațiile privind garanția de reparare gratuită a Sistemului Pluvia. Sunt excluse în mod expres orice alte revendicări din partea cumpărătorului împotriva Geberit pe baza acestei garanții suplimentare.

13.5 Garanția producătorului nu va acoperi: Defecțiuni mecanice.

Defecte și prejudicii care rezultă din instalare necorespunzătoare a produsului (datorită nerespectării instrucțiunilor menționate în manualul utilizatorului sau a unei exploatare necorespunzătoare),

Uzura prematură provocată de o instalare necorespunzătoare,
Defecțiuni care rezultă din nerespectarea recomandărilor producătorului referitor la utilizare.

Defecțiuni ca urmare a depunerii de calcar și a întreținerii neadecvate a produselor Ingerința sau modificarea construcției produsului întreprinse de către persoane neautorizate de către Geberit SRL

Orice reclamație de reparare sau înlocuire a mobilierului de baie deteriorat din cauza umidității

14. Diverse

Nulitatea sau lipsa de valabilitate în cazul oricărei prevederi incluse în cele sus menționate nu va afecta validitatea sau aplicabilitatea celorlalte prevederi din cadrul acestor condiții.

Într-un astfel de caz, părțile se angajează să înlocuiască prevederea în cauză cu o altă prevedere valabilă din punct de vedere legal, care se apropie de dispoziția invalidă cât mai aproape posibil, în interpretarea scopului economic al condițiilor. Acest lucru se aplică în mod corespunzător oricărei omisiuni din condiții.

Index

Cod articol	Pagină
12412	219
12413	219
12414	219
12415	219
12416	219
12417	219
12418	219
12419	219
12420	219
12421	219
19202	210
19203	210
19204	210
19205	210
19206	210
19207	210
19208	210
19402	211
19403	211
19404	211
19405	211
19406	211
19407	211
19408	211
19409	211
19410	211
19411	211
20101	213
20102	213
20103	213
20104	213
20105	213
20109	213
20110	213
20111	213
20212	226
20213	226
20214	226
20215	226
20216	226
20217	226
20218	226
20219	226
20220	226
20221	226
20301	214
20302	214
20303	214
20304	214
20305	214
20309	214
20310	214
20311	214
20402	214

Cod articol	Pagină
20403	214
20404	214
20405	214
20406	214
20407	214
20408	214
20502	222
20503	222
20505	222
20507	222
20508	222
20551	222
20552	222
20553	222
20555	222
20557	222
20558	222
20559	222
20560	222
20561	222
20562	222
20601	213
20602	213
20603	213
20604	213
20605	213
20609	213
20610	213
20611	213
20701	214
20702	214
20703	214
20704	214
20705	214
20709	214
20710	214
20711	214
20801	215
20802	215
20803	215
20804	215
20805	215
21001	215
21002	215
21003	215
21004	215
21005	215
21006	215
21007	215
21008	215
21009	215
21010	215
21011	215
21103	216

Cod articol	Pagină
21104	216
21105	216
21107	216
21121	218
21122	218
21123	218
21127	218
21128	218
21130	218
21131	218
21133	218
21134	218
21204	216
21206	216
21207	216
21209	216
21210	216
21211	216
21212	216
21213	216
21214	216
21215	216
21216	216
21217	216
21218	216
21219	216
21220	216
21221	216
21222	216
21223	216
21224	216
21225	216
21226	216
21230	216
21231	216
21232	216
21233	216
21234	216
21237	216
21238	216
21239	216
21240	216
21241	216
21245	216
21246	216
21247	216
21248	216
21249	216
21250	216
21304	217
21305	217
21307	217
21308	217
21309	217

Cod articol	Pagină
21310	217
21311	217
21312	217
21313	217
21314	217
21316	217
21317	217
21318	217
21320	217
21321	217
21322	217
21324	217
21326	217
21329	217
21331	217
21334	217
21336	217
21341	217
21342	217
21343	217
21344	217
21345	217
21346	217
21404	218
21406	218
21409	218
21504	218
21505	218
21506	218
21507	218
21509	218
21510	218
21512	218
21609	221
21610	221
21611	221
21612	221
21613	221
21615	221
21618	221
21659	222
21660	222
21661	222
21662	222
21700	220
21701	220
21702	220
21703	220
21704	220
21705	220
21707	220
21708	220
21709	220
21710	220



Cod articol	Pagină	Cod articol	Pagină	Cod articol	Pagină	Cod articol	Pagină
21711	220	22004	211	23107	213	23789	226
21713	220	22005	211	23108	213	23790	226
21714	220	22006	211	23306	214	23791	226
21715	220	22007	211	23307	214	23932	226
21716	220	22008	211	23308	214	23933	226
21717	220	22009	211	23509	222	23934	226
21719	220	22010	211	23510	222	23935	226
21720	220	22011	211	23511	222	23936	226
21721	220	22023	211	23602	227	23937	226
21722	220	22024	211	23603	227	23938	226
21724	220	22025	211	23604	227	23939	226
21725	220	22102	212	23606	213	23940	226
21727	220	22103	212	23607	213	23941	226
21800	220	22104	212	23608	213	24002	227
21801	220	22105	212	23615	253	24003	227
21802	220	22106	212	23616	253	24004	227
21803	220	22107	212	23617	253	24005	253
21804	220	22108	212	23706	214	24006	253
21805	220	22109	212	23707	214	24007	253
21806	221	22110	212	23708	214	24045	228
21807	221	22111	212	23715	251	24046	228
21808	221	22303	212	23716	251	24047	228
21809	221	22305	212	23717	251	24055	254
21810	221	22306	212	23718	251	24056	254
21811	221	22307	212	23719	251	24057	254
21814	221	22308	212	23720	251	25032	224
21818	221	22309	212	23721	251	25033	224
21820	221	22310	212	23744	224	25034	224
21823	220	22311	212	23745	224	25035	224
21824	221	22312	212	23746	224	25036	224
21827	220	22313	212	23747	224	25037	224
21902	221	22315	212	23748	224	25038	224
21903	221	22316	212	23749	224	25040	224
21904	221	22317	212	23750	224	25042	223
21905	221	22318	212	23751	224	25044	224
21906	221	22320	212	23754	225	25045	224
21908	221	22321	212	23755	225	25046	224
21910	221	22322	212	23756	225	25048	223
21912	221	22323	212	23757	225	25049	223
21914	221	22324	212	23758	225	25050	224
21916	221	22330	212	23759	225	25051	224
21918	221	22331	212	23760	225	25052	224
21920	221	22332	212	23761	225	25053	224
21922	221	22338	212	23764	225	25054	224
21932	220	22339	212	23765	225	25055	224
21933	220	22345	212	23766	225	25073	228
21934	220	22346	212	23767	225	25300	223
21935	220	22348	212	23768	225	25302	223
21936	220	22421	194	23769	225	25304	223
21937	220	22422	194	23770	225	25305	223
21938	220	22423	194	23771	225	25306	223
21939	220	22431	194	23784	226	25307	223
21940	220	22432	194	23785	226	25308	223
22001	211	22433	194	23786	226	25309	223
22002	211	22444	194	23787	226	25320	223
22003	211	23106	213	23788	226	25321	223

Cod articol	Pagină	Cod articol	Pagină	Cod articol	Pagină	Cod articol	Pagină
25322	223	30602	181	31204	184	31313	186
25323	223	30603	181	31206	184	31314	186
25324	223	30604	181	31207	184	31316	186
25325	223	30605	181	31208	184	31317	186
25326	223	30702	182	31209	184	31318	186
25329	223	30703	182	31210	184	31320	186
25330	223	30704	182	31211	184	31321	186
25332	223	30705	182	31212	184	31322	186
25335	223	30802	183	31213	184	31324	186
25337	223	30803	183	31214	184	31326	186
25338	223	30804	183	31215	184	31329	186
25339	223	30805	183	31216	184	31331	186
25340	223	30872	183	31217	184	31334	186
29101	210	30873	183	31218	184	31336	186
29102	210	30874	183	31219	184	31339	186
29103	210	30875	183	31220	184	31401	185
29104	210	30876	183	31221	184	31454	185
29105	210	30877	183	31222	184	31455	185
29106	210	30878	183	31223	184	31458	185
29107	210	30892	182	31224	184	31461	185
29108	210	30893	182	31225	184	31464	185
29159	210	30894	182	31226	184	31703	188
29160	210	30905	182	31227	184	31704	188
29161	210	30906	182	31228	184	31705	188
30009	182	30907	182	31229	184	31707	188
30010	182	30908	182	31230	184	31708	188
30011	182	30932	182	31231	184	31709	188
30029	182	30933	182	31232	185	31710	188
30030	182	30934	182	31233	185	31711	188
30031	182	30935	182	31234	184	31713	188
30049	183	30936	182	31235	184	31714	188
30050	183	30937	182	31236	185	31715	188
30051	183	30938	182	31237	185	31716	188
30069	183	30942	183	31238	185	31717	188
30070	183	30943	183	31239	185	31718	188
30071	183	30944	183	31240	185	31719	188
30089	183	30955	183	31241	185	31720	188
30090	183	30956	183	31242	184	31721	188
30091	183	30957	183	31243	184	31722	188
30102	181	30958	183	31244	185	31724	188
30103	181	31002	184	31245	185	31726	188
30104	181	31003	184	31246	185	31731	188
30105	181	31004	184	31247	185	31732	188
30302	182	31005	184	31248	185	31733	188
30303	182	31006	184	31249	185	31734	188
30304	182	31007	184	31250	185	31735	188
30305	182	31008	184	31251	184	31736	188
30402	183	31009	184	31304	186	31737	188
30403	183	31010	184	31305	186	31738	188
30404	183	31011	184	31306	186	31801	189
30405	183	31106	181	31307	186	31802	189
30406	183	31107	181	31308	186	31803	189
30407	183	31108	181	31309	186	31804	189
30408	183	31109	181	31310	186	31805	189
30414	183	31110	181	31311	186	31806	189
30415	183	31111	181	31312	186	31807	189



Cod articol	Pagină	Cod articol	Pagină	Cod articol	Pagină	Cod articol	Pagină
31809	189	32315	180	33735	194	35133	192
31811	189	32316	180	33736	194	35134	192
31814	189	32317	180	33737	194	35300	193
31818	189	32318	180	33738	194	35301	193
31819	189	32319	180	33739	194	35302	193
31820	189	32320	180	33740	194	35303	193
31821	189	32321	180	33741	194	35304	193
31822	189	32322	180	33744	195	35305	193
31823	189	32323	180	33745	195	35306	193
31824	189	32324	180	33746	195	35307	193
31825	189	32331	180	33747	195	35308	193
31826	189	32338	180	33748	195	35309	193
31833	188	32339	180	33749	195	35320	191
31837	188	32345	180	33750	195	35321	191
31838	188	32346	180	33752	195	35322	191
31839	188	32348	180	33802	190	35323	191
31840	188	32606	181	33803	190	35324	191
31841	188	32607	181	33804	190	35325	191
31932	189	32608	181	33805	190	35326	191
31933	189	32609	181	33806	190	35330	192
31936	189	32610	181	33807	190	35331	192
31937	189	32611	181	33808	190	35332	192
31938	189	32706	182	33833	190	35333	192
31939	189	32707	182	33834	190	35334	192
31940	189	32708	182	33835	190	35335	192
32002	179	32709	182	33836	190	35336	192
32003	179	32710	182	33837	190	35337	192
32004	179	32711	182	33838	190	35338	192
32005	179	33001	179	33839	190	35339	192
32006	179	33008	184	33932	196	35340	192
32007	179	33203	190	33933	196	35350	193
32008	179	33212	197	33934	196	35351	193
32009	179	33213	197	33935	196	35352	193
32010	179	33214	197	33936	196	35353	193
32011	179	33215	197	33937	196	35354	193
32102	180	33216	197	33938	196	35355	193
32103	180	33217	197	33939	196	35356	193
32104	180	33218	197	33940	196	35357	193
32105	180	33219	197	33941	196	35358	193
32106	180	33220	197	35032	191	35359	193
32107	180	33221	197	35033	191	35360	192
32108	180	33306	182	35034	191	35361	192
32109	180	33307	182	35035	191	35362	192
32110	180	33308	182	35036	191	35363	192
32111	180	33309	182	35037	191	35364	192
32303	180	33310	182	35038	191	35365	192
32305	180	33311	182	35039	191	35366	192
32306	180	33403	197	35040	191	35367	192
32307	180	33405	197	35042	191	35368	192
32308	180	33407	197	35044	191	35369	192
32309	180	33423	197	35045	191	35370	192
32310	180	33425	197	35046	191	35380	194
32311	180	33427	197	35047	191	35382	194
32312	180	33732	194	35072	191	35384	194
32313	180	33733	194	35075	192	35386	194
32314	180	33734	194	35132	192	35387	194

Cod articol	Pagină	Cod articol	Pagină	Cod articol	Pagină	Cod articol	Pagină
35388	194	36169	181	60112	242	60908	243
35389	194	36170	181	60113	242	60935	243
35390	191	39002	178	60231	251	60936	243
35391	191	39003	178	60232	251	60937	243
35392	191	39004	178	60233	251	60938	243
35393	191	39005	178	60234	251	60955	243
35394	191	39006	178	60235	251	60956	243
35395	191	39007	178	60236	251	60957	243
35396	191	39008	178	60237	251	60958	243
35400	193	39009	178	60238	251	61000	244
35402	193	39010	178	60240	251	61002	244
35405	193	39011	178	60241	251	61003	244
35407	193	39041	178	60242	251	61004	244
35408	193	39042	178	60301	242	61005	244
35409	193	39043	178	60302	242	61006	244
35410	193	39044	178	60303	242	61007	244
36101	181	39045	178	60304	242	61008	244
36103	181	39046	178	60305	242	61011	244
36104	181	39047	178	60306	242	61012	244
36105	181	39048	178	60307	243	61013	244
36106	181	39102	179	60308	243	61104	244
36107	181	39103	179	60311	243	61212	244
36108	181	39104	179	60312	243	61213	244
36109	181	39105	179	60313	243	61214	244
36110	181	39106	179	60601	242	61215	244
36121	181	39107	179	60602	242	61217	244
36123	181	39108	179	60603	242	61218	244
36124	181	39609	179	60604	242	61219	244
36125	181	39610	179	60605	242	61220	244
36126	181	39611	179	60606	242	61225	244
36127	181	56319	268	60607	242	61226	244
36128	181	56321	268	60608	242	61227	244
36129	181	56322	268	60611	242	61228	244
36130	181	56323	268	60612	242	61229	244
36141	196	56324	268	60613	242	61235	244
36142	196	56325	268	60701	242	61236	244
36143	196	56326	268	60702	242	61240	244
36144	196	56327	268	60703	242	61242	244
36145	196	56328	268	60704	242	61244	244
36146	196	56329	268	60705	242	61252	244
36147	196	60082	243	60706	242	61253	244
36148	196	60083	243	60707	242	61254	244
36150	195	60084	243	60708	242	61256	244
36151	195	60085	243	60711	242	61257	244
36152	195	60086	243	60712	242	61259	244
36153	195	60087	243	60713	242	61260	244
36154	195	60088	243	60802	243	61261	244
36155	195	60101	242	60803	243	61283	244
36156	195	60102	242	60804	243	61284	244
36161	181	60103	242	60875	243	61285	244
36163	181	60104	242	60876	243	61286	244
36164	181	60105	242	60877	243	61287	244
36165	181	60106	242	60878	243	61288	245
36166	181	60107	242	60905	243	61289	245
36167	181	60108	242	60906	243	61290	245
36168	181	60111	242	60907	243	61292	245



Cod articol	Pagină	Cod articol	Pagină	Cod articol	Pagină	Cod articol	Pagină
61293	245	61824	247	62338	241	63895	248
61294	245	61825	247	62339	241	65040	250
61295	245	61845	247	62340	241	65044	250
61296	245	61846	247	62341	241	65045	250
61297	245	61932	247	63113	227	65046	250
61352	245	61933	247	63115	227	65050	250
61354	245	61935	247	63117	227	65051	250
61355	245	61936	247	63118	227	65052	250
61357	245	62001	240	63125	227	65053	250
61359	245	62002	240	63452	252	65054	250
61360	245	62003	240	63453	252	65081	250
61362	245	62004	240	63455	252	65082	250
61366	245	62005	240	63457	252	65083	250
61370	245	62006	240	63458	252	65084	250
61395	245	62007	240	63459	252	65085	250
61404	245	62008	240	63460	252	65086	250
61406	245	62011	240	63462	252	65087	250
61409	245	62012	240	63463	252	65088	250
61504	245	62013	240	63464	252	65090	250
61505	245	62024	246	63473	252	65091	250
61506	245	62050	240	63558	247	65182	250
61701	246	62055	240	63559	247	65382	249
61702	246	62102	240	63560	247	65384	249
61703	246	62103	240	63561	247	65385	249
61704	246	62104	240	63562	247	65386	249
61705	246	62105	240	63564	247	65387	249
61707	246	62106	240	63565	247	65388	249
61708	246	62107	240	63706	251	65392	249
61709	246	62108	240	63707	251	65481	249
61710	246	62111	240	63708	251	65482	249
61711	246	62112	240	63709	251	65483	249
61714	246	62113	240	63711	251	65484	249
61715	246	62301	241	63712	251	65485	249
61716	246	62302	241	63713	251	65486	249
61717	246	62303	241	63853	248	65487	249
61718	246	62305	241	63854	248	65488	249
61719	246	62306	241	63855	248	65490	249
61721	246	62307	241	63856	248	65491	249
61732	246	62308	241	63857	248	65492	249
61733	246	62309	241	63860	248	65531	249
61734	246	62312	241	63861	248	65532	249
61745	246	62313	241	63862	248	65533	249
61801	247	62316	241	63863	248	65534	249
61802	247	62317	241	63864	248	65535	249
61803	247	62318	241	63865	248	65536	249
61804	247	62322	241	63866	248	65537	249
61805	247	62323	241	63873	248	65538	249
61806	247	62324	241	63884	248	65540	249
61809	247	62329	241	63885	248	65541	249
61811	247	62330	241	63886	248	65542	249
61814	247	62331	241	63887	248	65543	249
61818	247	62332	241	63888	248	65544	249
61819	247	62333	241	63889	248	67002	268
61820	247	62334	241	63892	248	67004	268
61821	247	62336	241	63893	248	67005	268
61823	247	62337	241	63894	248	67006	268

Cod articol	Pagină	Cod articol	Pagină	Cod articol	Pagină	Cod articol	Pagină
67007	268	67313	269	67705	271	68699	275
67008	268	67317	269	67706	271	68700	275
67009	268	67318	269	67707	271	68701	275
67010	268	67323	269	67708	271	68703	273
67011	268	67324	269	67709	271	68707	273
67102	269	67325	269	67710	271	68708	273
67104	269	67327	269	67711	271	68709	273
67105	269	67330	269	67802	274	68710	273
67106	269	67337	269	67805	274	68711	273
67107	269	67338	269	67806	274	68715	273
67108	269	67344	273	67809	274	68716	270
67109	269	67346	269	67811	274	68718	270
67110	269	67347	273	67814	274	68719	270
67111	269	67348	273	67818	274	68720	270
67206	273	67349	273	68002	272	68721	270
67209	273	67350	273	68004	272	68722	270
67211	273	67352	273	68005	272	68723	270
67212	273	67353	273	68006	272	68724	270
67214	273	67356	273	68007	272	68725	270
67215	273	67357	273	68008	272	68736	270
67218	273	67360	273	68009	272	68738	270
67219	273	67361	273	68010	272	68739	270
67220	273	67366	273	68011	272	68740	270
67225	273	67369	273	68102	270	68741	270
67226	273	67373	273	68104	270	68742	270
67227	273	67402	271	68105	270	68743	270
67228	273	67404	271	68106	270	68744	270
67229	273	67405	271	68107	270	68745	270
67230	273	67406	271	68108	270	68756	276
67231	273	67407	271	68109	270	68757	276
67232	275	67408	271	68110	270	68758	276
67233	273	67503	274	68111	270	68759	276
67234	275	67506	274	68302	271	68760	276
67235	275	67507	274	68304	271	68761	276
67236	275	67508	274	68305	271	68762	276
67237	275	67509	274	68306	271	68763	276
67238	275	67510	274	68307	271	68791	276
67239	273	67511	274	68308	271	68793	276
67243	275	67515	274	68309	271	68794	276
67244	273	67516	274	68310	271	68795	276
67245	273	67517	274	68311	271	68796	276
67246	273	67518	274	68682	275	68797	276
67247	273	67519	274	68684	275	68798	276
67248	273	67520	274	68685	275	68799	276
67250	273	67521	274	68686	275	68804	270
67251	273	67602	270	68687	275	68806	270
67252	273	67604	270	68688	275	68807	270
67253	273	67605	270	68689	275	68808	270
67260	273	67606	270	68690	275	68809	270
67261	273	67607	270	68691	275	68810	270
67269	273	67608	270	68692	275	68811	270
67270	273	67609	270	68694	275	68812	270
67305	269	67610	270	68695	275	68813	270
67307	269	67611	270	68696	275	68833	273
67309	269	67702	271	68697	275	68837	273
67312	269	67704	271	68698	275	68838	273



Cod articol	Pagină	Cod articol	Pagină	Cod articol	Pagină	Cod articol	Pagină
68839	273	90881	201	91159	202	92154	288
68840	273	90882	201	91160	202	92155	288
68841	273	90883	201	91161	202	92156	288
90081	202	90884	201	91164	158	92157	288
90082	202	90885	201	91165	158	92158	288
90083	202	90886	201	91166	158	92159	288
90084	202	90887	201	91167	158	94862	284
90085	202	90888	201	91168	158	94863	284
90086	202	90891	201	91169	158	94864	284
90088	202	90892	201	91170	158	94865	284
90089	202	90893	201	91171	158	94866	284
90092	202	90922	326	91172	158	94882	284
90094	202	90923	326	91173	158	94883	284
90095	202	90924	326	92080	276	94884	284
90096	202	90925	326	92082	276	94885	284
90097	202	90926	326	92083	276	94886	284
90098	202	90927	326	92084	276	94887	284
90282	200	90928	326	92085	276	94888	284
90341	326	90929	326	92086	276	94902	284
90342	326	90930	326	92087	277	94903	284
90343	326	90931	326	92088	277	94904	284
90344	327	90932	189	92089	277	94905	284
90345	327	90933	189	92100	286	94912	287
90346	327	90934	189	92101	286	94913	287
90347	327	90935	189	92102	286	94914	287
90348	327	90936	189	92103	286	94922	285
90349	327	90980	196	92104	286	94923	285
90350	327	90981	196	92105	286	94924	285
90351	325	90982	196	92106	286	94925	285
90358	326	90983	196	92107	286	94926	285
90363	324	90984	196	92108	286	94927	285
90365	325	90985	196	92109	286	94928	285
90372	325	90986	196	92110	286	94935	285
90373	325	90987	196	92112	286	94936	285
90374	325	90988	196	92120	286	94937	285
90375	325	90989	196	92122	286	94938	285
90376	325	91064	158	92123	286	94952	285
90391	325	91065	158	92124	286	94953	285
90394	325	91066	158	92125	286	94954	285
90396	325	91067	158	92126	286	94955	285
90401	201	91068	158	92127	286	94956	285
90402	201	91069	158	92128	286	94957	285
90403	201	91070	158	92129	286	94958	285
90404	201	91071	158	92132	287	152.149.16.1	24
90405	201	91072	158	92140	287	152.150.16.1	24
90406	201	91073	158	92142	287	152.151.16.1	24
90407	201	91087	324	92143	287	152.152.16.1	24
90408	201	91088	324	92144	287	152.197.16.1	24
90409	201	91092	324	92145	287	152.198.16.1	24
90410	201	91152	202	92146	287	152.495.00.1	39
90411	201	91153	202	92147	287	152.496.00.1	39
90412	231	91154	202	92148	287	152.498.00.1	39
90563	326	91155	202	92149	287	152.651.16.1	24
90797	322	91156	202	92150	288	152.652.16.1	24
90798	322	91157	202	92152	288	152.654.16.1	24
90799	322	91158	202	92153	288	152.657.16.1	24

Cod articol	Pagină	Cod articol	Pagină	Cod articol	Pagină	Cod articol	Pagină
152.658.16.1	24	305.906.14.1	78	308.078.14.1	69	310.101.14.1	73
152.661.16.1	24	305.921.00.1	112	308.081.14.1	73	310.102.14.1	70
152.682.00.1	39	306.000.14.1	66	308.082.14.1	70	310.104.14.1	68
152.689.00.1	39	306.008.14.1	68	308.084.14.1	68	310.105.14.1	70
152.690.00.1	39	306.050.14.1	73	308.088.14.1	69	310.106.14.1	74
152.691.00.1	39	306.054.14.1	68	308.089.14.1	69	310.108.14.1	69
152.692.00.1	39	306.058.14.1	69	308.150.14.1	66	310.115.14.1	72
152.693.00.1	39	306.064.14.1	68	308.300.14.1	66	310.117.14.1	71
152.796.00.1	39	306.068.14.1	69	308.333.14.1	74	310.150.14.1	66
153.564.16.1	39	306.150.14.1	66	308.450.14.1	66	310.171.14.1	72
153.565.16.1	39	306.300.14.1	66	308.480.14.1	16	310.172.14.1	72
153.566.16.1	39	306.450.14.1	66	308.600.14.1	67	310.300.14.1	66
240.474.00.1	298	306.600.14.1	67	308.670.14.1	66	310.334.14.1	74
240.669.00.1	305	306.812.26.1	78	308.811.14.1	71	310.345.14.1	74
241.785.00.1	40	306.820.00.1	112	308.812.26.1	78	310.445.14.1	71
241.786.00.1	40	306.880.14.1	67	308.815.14.1	72	310.450.14.1	66
241.787.00.1	40	306.885.14.1	67	308.817.14.1	71	310.481.14.1	16
241.790.00.1	40	306.921.00.1	112	308.871.14.1	72	310.600.14.1	67
241.791.00.1	40	307.000.14.1	66	308.872.14.1	72	310.670.14.1	66
241.792.00.1	98	307.003.14.3	75	308.874.14.1	72	310.811.14.1	71
241.793.00.1	98	307.005.14.1	80	308.875.14.1	72	310.812.26.1	78
241.794.00.1	98	307.012.14.1	75	308.880.14.1	67	310.813.14.1	71
241.795.00.1	98	307.050.14.1	73	308.881.14.1	77	310.815.14.1	72
241.796.00.1	98	307.054.14.1	68	308.883.14.1	77	310.817.14.1	71
241.798.00.1	99	307.058.14.1	69	308.885.14.1	67	310.820.00.1	112
241.799.00.1	99	307.060.14.1	73	308.915.00.2	41	310.850.14.1	78
241.885.00.1	99	307.064.14.1	68	308.921.00.1	112	310.871.14.1	72
242.278.00.1	40	307.068.14.1	69	308.923.14.1	77	310.872.14.1	72
242.279.00.1	40	307.074.14.1	68	308.969.00.1	45	310.874.14.1	72
242.280.00.1	40	307.078.14.1	69	310.000.14.1	66	310.875.14.1	72
242.281.00.1	98	307.150.14.1	66	310.003.14.3	75	310.880.14.1	67
242.282.00.1	98	307.300.14.1	66	310.005.14.1	80	310.881.14.1	77
242.283.00.1	98	307.333.14.1	74	310.006.00.1	108	310.883.14.1	77
242.462.00.1	302	307.345.14.1	74	310.007.00.1	108	310.885.14.1	67
242.614.P1.1	328	307.450.14.1	66	310.008.14.1	68	310.915.00.2	41
242.827.00.1	302	307.600.14.1	67	310.012.14.1	75	310.917.00.1	81
242.828.00.1	302	307.670.14.1	66	310.014.14.1	67	310.921.00.1	112
244.126.00.1	40	307.812.26.1	78	310.048.14.1	68	310.923.14.1	77
244.127.00.1	40	307.820.00.1	112	310.050.14.1	73	310.969.00.1	45
300.007.00.2	113	307.880.14.1	67	310.052.14.1	74	312.000.14.1	66
305.000.14.1	66	307.885.14.1	67	310.054.14.1	68	312.003.14.3	75
305.003.14.3	75	307.915.00.2	41	310.058.14.1	69	312.005.14.1	80
305.005.14.1	80	307.921.00.1	112	310.060.14.1	73	312.012.14.1	75
305.040.14.3	78	308.000.14.1	66	310.062.14.1	74	312.014.14.1	67
305.054.14.1	68	308.003.14.3	75	310.064.14.1	68	312.100.14.1	73
305.058.14.1	69	308.005.14.1	80	310.068.14.1	69	312.104.14.1	68
305.150.14.1	66	308.012.14.1	75	310.070.14.1	73	312.108.14.1	69
305.300.14.1	66	308.014.14.1	67	310.072.14.1	74	312.109.14.1	69
305.450.14.1	66	308.050.14.1	73	310.074.14.1	68	312.124.14.1	68
305.600.14.1	67	308.054.14.1	68	310.078.14.1	69	312.125.14.1	73
305.670.14.1	66	308.058.14.1	69	310.080.14.1	73	312.128.14.1	69
305.812.26.1	78	308.060.14.1	73	310.081.14.1	73	312.140.00.2	76
305.820.00.1	112	308.064.14.1	68	310.082.14.1	74	312.150.14.1	66
305.880.14.1	67	308.068.14.1	69	310.083.14.1	70	312.300.14.1	66
305.885.14.1	67	308.070.14.1	73	310.084.14.1	68	312.333.14.1	74
305.905.14.1	78	308.074.14.1	68	310.088.14.1	69	312.450.14.1	66



Cod articol	Pagină	Cod articol	Pagină	Cod articol	Pagină	Cod articol	Pagină
312.600.14.1	67	358.503.00.1	302	359.346.00.1	52	359.778.00.1	297
312.771.16.1	75	358.504.00.1	302	359.347.00.1	52	359.799.00.1	298
312.812.26.1	78	358.729.00.1	302	359.421.00.1	26	359.809.00.1	299
312.813.26.1	78	358.759.00.1	298	359.423.00.1	26	359.811.00.1	299
312.820.00.1	112	358.760.00.1	298	359.424.00.2	22	359.812.00.1	299
312.880.14.1	67	358.829.00.1	60	359.425.00.2	22	359.813.00.1	299
312.885.14.1	67	359.006.25.1	60	359.426.00.2	22	359.814.00.1	299
312.921.00.1	112	359.007.00.1	54	359.427.00.2	22	359.816.00.1	299
315.001.14.1	66	359.009.P0.1	301	359.428.00.2	22	359.817.00.1	299
315.003.14.3	75	359.013.00.1	44	359.429.00.2	22	359.818.00.1	299
315.005.14.1	80	359.034.00.1	53	359.430.00.2	22	359.819.00.1	299
315.012.14.1	75	359.036.00.1	56	359.431.00.2	22	359.820.00.1	300
315.100.14.1	73	359.037.00.1	44	359.432.00.2	22	359.822.00.1	299
315.104.14.1	69	359.038.00.1	44	359.433.00.2	22	359.835.00.1	300
315.108.14.1	70	359.039.00.1	45	359.434.00.2	22	359.836.00.1	300
315.124.14.1	69	359.042.00.1	61	359.435.00.2	22	359.860.00.1	302
315.126.14.1	73	359.046.P2.1	297	359.436.00.2	22	359.884.00.1	299
315.128.14.1	70	359.048.P0.1	304	359.437.00.2	22	359.886.00.2	296
315.144.14.1	68	359.052.00.1	299	359.438.00.2	22	359.900.00.1	108
315.148.14.1	69	359.053.00.1	299	359.439.00.2	22	359.910.P0.1	292
315.150.14.1	66	359.054.00.1	299	359.440.00.2	22	359.911.P0.1	292
315.300.14.1	66	359.056.00.1	299	359.441.00.2	22	359.912.00.1	303
315.333.14.1	74	359.057.00.1	299	359.442.00.2	22	359.914.00.1	305
315.450.14.1	66	359.059.00.1	299	359.443.00.2	22	359.915.00.1	303
315.812.26.1	78	359.060.P2.1	297	359.444.00.2	23	359.916.00.1	303
315.813.26.1	79	359.062.00.1	301	359.445.00.2	23	359.922.00.1	304
315.820.00.1	112	359.082.P2.1	297	359.446.00.2	76	359.923.00.1	304
315.885.14.1	67	359.098.00.1	51	359.447.00.2	23	359.924.00.1	304
348.300.00.1	112	359.099.00.1	52	359.448.00.2	23	359.925.00.1	304
348.301.00.1	112	359.100.00.1	54	359.449.00.2	23	359.926.00.1	304
348.302.00.1	112	359.101.00.1	56	359.450.00.2	23	359.930.00.1	305
348.303.00.1	112	359.102.00.1	45	359.451.00.2	23	359.971.00.1	61
348.304.00.1	112	359.105.00.1	49	359.454.00.1	23	360.000.16.0	8
348.305.00.1	112	359.106.00.1	50	359.455.00.1	23	360.045.16.1	8
348.306.00.1	112	359.108.00.1	51	359.456.00.1	23	360.055.16.1	9
356.010.00.1	113	359.111.00.1	53	359.457.00.1	23	360.108.16.1	11
356.011.00.1	113	359.112.00.1	53	359.458.00.1	23	360.109.16.1	11
356.012.00.1	113	359.113.00.1	55	359.459.00.1	23	360.158.16.1	12
356.013.00.1	113	359.114.00.1	56	359.461.16.1	23	360.159.16.1	12
356.014.00.1	113	359.117.00.1	50	359.462.00.1	23	360.557.16.1	18
356.015.00.1	113	359.118.00.1	50	359.463.00.1	23	360.700.16.1	21
356.116.00.1	292	359.119.00.1	60	359.464.00.1	23	360.719.16.1	26
356.118.00.1	303	359.122.00.1	60	359.465.00.2	22	360.720.16.1	26
356.201.00.1	295	359.123.00.1	62	359.504.00.1	61	360.721.16.1	26
356.831.00.1	302	359.124.00.1	61	359.635.00.1	61	360.740.16.1	24
357.449.00.1	300	359.127.00.1	51	359.641.P0.2	296	360.750.16.1	25
357.599.00.1	298	359.133.00.1	45	359.662.00.1	295	360.771.16.1	20
357.600.00.1	298	359.147.00.1	44	359.663.00.1	301	360.772.16.1	28
357.751.00.1	298	359.309.00.1	26	359.665.P0.2	296	360.779.16.3	22
357.799.00.1	303	359.311.00.1	26	359.673.00.1	296	360.781.16.1	38
357.800.00.1	300	359.313.00.1	26	359.675.P0.2	296	360.802.92.1	38
358.033.00.1	60	359.330.00.1	23	359.684.00.1	301	360.812.16.1	38
358.061.00.1	62	359.342.00.1	54	359.691.00.1	300	360.832.00.2	33
358.062.00.1	62	359.343.00.1	54	359.696.00.1	301	360.841.00.2	32
358.501.00.1	304	359.344.00.1	55	359.698.00.0	301	360.842.00.1	33
358.502.00.1	302	359.345.00.1	52	359.720.00.1	304	360.843.00.2	32

Cod articol	Pagină	Cod articol	Pagină	Cod articol	Pagină	Cod articol	Pagină
360.850.00.1	37	362.837.26.1	35	363.750.16.1	25	364.772.16.1	28
360.861.00.1	57	362.839.26.1	35	363.771.16.1	20	364.776.16.1	34
361.000.16.0	8	362.843.26.1	36	363.772.16.1	28	364.779.16.3	22
361.045.16.1	8	362.844.26.1	36	363.776.16.1	34	364.781.16.1	38
361.055.16.1	9	362.848.26.1	35	363.779.16.3	22	364.802.92.1	38
361.080.16.1	29	362.851.26.1	34	363.781.16.1	38	364.812.16.1	38
361.088.16.1	8	362.852.26.1	36	363.802.92.1	38	364.832.00.2	33
361.109.16.1	11	362.853.26.1	36	363.812.16.1	38	364.841.00.2	32
361.112.16.1	11	362.854.26.1	36	363.832.00.2	33	364.842.00.1	33
361.159.16.1	12	362.855.26.1	36	363.841.00.2	32	364.843.00.2	32
361.162.16.1	12	362.856.26.1	37	363.842.00.1	33	364.850.00.1	37
361.459.16.1	16	362.857.26.1	36	363.843.00.2	32	364.861.00.1	57
361.462.16.1	16	362.858.26.1	36	363.850.00.1	37	364.873.16.1	10
361.557.16.1	18	362.859.26.1	36	363.861.00.1	57	364.874.16.1	10
361.558.16.1	16	362.862.26.1	57	363.862.00.1	59	364.989.16.2	20
361.559.16.1	18	362.863.26.1	56	363.863.00.1	58	365.000.16.0	8
361.666.16.1	120	362.864.26.1	57	363.864.00.1	58	365.045.16.1	8
361.673.00.1	114	362.865.26.1	57	363.873.16.1	10	365.046.16.1	9
361.674.00.1	114	362.868.26.1	35	364.000.16.0	8	365.055.16.1	9
361.700.16.1	21	362.869.26.1	35	364.045.16.1	8	365.088.16.1	9
361.719.16.1	26	362.874.26.1	35	364.055.16.1	9	365.109.16.1	11
361.720.16.1	26	362.875.26.1	37	364.084.16.1	29	365.112.16.1	11
361.721.16.1	26	362.876.26.1	37	364.088.16.1	8	365.115.16.1	11
361.722.16.1	26	362.877.26.1	37	364.109.16.1	11	365.120.16.1	11
361.723.16.1	26	362.878.26.1	37	364.112.16.1	11	365.125.16.1	11
361.726.16.1	25	362.879.26.1	37	364.115.16.1	11	365.159.16.1	12
361.727.16.1	25	362.880.26.1	37	364.120.16.1	11	365.162.16.1	12
361.740.16.1	24	363.000.16.0	8	364.159.16.1	12	365.165.16.1	12
361.742.00.1	39	363.045.16.1	8	364.162.16.1	12	365.170.16.1	12
361.743.26.1	28	363.055.16.1	9	364.165.16.1	12	365.175.16.1	12
361.744.16.1	27	363.080.16.1	29	364.170.16.1	12	365.275.16.1	14
361.745.00.1	27	363.083.16.1	29	364.270.16.1	14	365.325.16.1	13
361.748.00.1	27	363.088.16.1	8	364.320.16.1	13	365.375.16.1	14
361.750.16.1	25	363.112.16.1	11	364.370.16.1	14	365.451.16.1	18
361.752.16.3	22	363.115.16.1	11	364.451.16.1	18	365.465.16.1	16
361.771.16.1	20	363.162.16.1	12	364.462.16.1	16	365.470.16.1	16
361.772.16.1	28	363.165.16.1	12	364.465.16.1	16	365.472.16.1	30
361.776.16.1	34	363.462.16.1	16	364.558.16.1	16	365.558.16.1	16
361.779.16.3	22	363.465.16.1	16	364.559.16.1	18	365.559.16.1	18
361.781.16.1	38	363.472.16.1	30	364.560.16.1	18	365.560.16.1	18
361.802.92.1	38	363.558.16.1	16	364.561.16.1	16	365.561.16.1	16
361.812.16.1	38	363.559.16.1	18	364.565.16.1	18	365.565.16.1	18
361.832.00.2	33	363.560.16.1	18	364.566.16.1	16	365.566.16.1	16
361.841.00.2	32	363.561.16.1	16	364.600.16.1	15	365.570.16.1	18
361.842.00.1	33	363.660.00.1	121	364.605.16.1	14	365.571.16.1	16
361.843.00.2	32	363.673.00.1	114	364.610.16.1	15	365.600.16.1	15
361.850.00.1	37	363.674.00.1	114	364.700.16.1	21	365.605.16.1	14
361.861.00.1	57	363.700.16.1	21	364.724.16.1	26	365.610.16.1	15
361.872.16.1	10	363.724.16.1	26	364.728.16.1	25	365.673.00.1	114
362.781.16.1	38	363.728.16.1	25	364.730.16.1	31	365.674.00.1	114
362.826.26.1	35	363.740.16.1	24	364.740.16.1	24	365.700.16.1	21
362.827.26.1	35	363.742.00.1	39	364.744.16.1	27	365.725.16.1	26
362.828.26.1	35	363.744.16.1	27	364.749.16.1	25	365.729.16.1	25
362.833.00.1	37	363.745.00.1	27	364.750.16.1	25	365.730.16.1	31
362.834.26.1	36	363.748.00.1	27	364.752.16.3	22	365.740.16.1	25
362.836.00.1	36	363.749.16.1	25	364.771.16.1	20	365.742.00.1	39



Cod articol	Pagină	Cod articol	Pagină	Cod articol	Pagină	Cod articol	Pagină
365.744.16.1	27	366.743.26.1	28	367.330.16.1	13	367.813.16.1	32
365.745.00.1	27	366.744.16.1	27	367.335.16.1	13	367.819.92.1	40
365.748.00.1	27	366.745.00.1	27	367.362.16.1	14	367.832.00.2	33
365.750.16.1	25	366.748.00.1	27	367.365.16.1	14	367.841.00.2	32
365.771.16.1	21	366.750.16.1	25	367.370.16.1	14	367.842.00.1	33
365.772.16.1	28	366.771.16.1	21	367.375.16.1	14	367.843.00.2	32
365.776.16.1	34	366.772.16.1	28	367.380.16.1	14	367.850.00.1	37
365.779.16.3	22	366.776.16.1	34	367.385.16.1	14	367.861.00.1	57
365.781.16.1	38	366.779.16.3	22	367.445.16.1	15	367.880.16.1	28
365.802.92.1	38	366.781.16.1	38	367.451.16.1	19	367.885.16.1	31
365.812.16.1	38	366.802.92.1	38	367.453.16.1	18	367.887.16.1	31
365.813.16.1	32	366.812.16.1	38	367.454.16.1	19	367.888.16.1	29
365.832.00.2	33	366.820.92.1	40	367.471.16.1	25	367.903.16.1	29
365.841.00.2	32	366.832.00.2	33	367.480.16.1	16	367.904.16.1	30
365.842.00.1	33	366.841.00.2	32	367.481.16.1	16	367.923.16.1	29
365.843.00.2	32	366.842.00.1	33	367.485.16.1	30	367.925.16.1	29
365.850.00.1	37	366.843.00.2	32	367.550.16.1	24	367.928.16.1	19
365.861.00.1	57	366.850.00.1	37	367.551.16.1	24	367.941.16.1	30
365.989.16.2	20	366.861.00.1	57	367.558.16.1	16	367.989.16.2	20
366.000.16.0	8	366.887.16.1	31	367.559.16.1	18	368.000.16.0	8
366.045.16.1	8	366.925.16.1	29	367.560.16.1	18	368.045.16.1	8
366.055.16.1	9	366.941.16.1	30	367.561.16.1	16	368.055.16.1	9
366.088.16.1	9	366.989.16.2	20	367.565.16.1	18	368.088.16.1	9
366.109.16.1	11	367.000.16.0	8	367.566.16.1	16	368.120.16.1	11
366.112.16.1	11	367.009.16.1	94	367.570.16.1	18	368.125.16.1	11
366.115.16.1	11	367.045.16.1	8	367.571.16.1	16	368.130.16.1	11
366.120.16.1	11	367.046.16.1	9	367.575.16.1	18	368.135.16.1	11
366.125.16.1	11	367.055.16.1	9	367.576.16.1	16	368.139.16.1	11
366.130.16.1	11	367.088.16.1	9	367.580.16.1	18	368.162.16.1	12
366.159.16.1	12	367.109.16.1	11	367.581.16.1	16	368.165.16.1	12
366.162.16.1	12	367.112.16.1	11	367.600.16.1	15	368.170.16.1	12
366.165.16.1	12	367.115.16.1	11	367.605.16.1	14	368.175.16.1	12
366.170.16.1	12	367.120.16.1	11	367.610.16.1	15	368.180.16.1	12
366.175.16.1	12	367.125.16.1	11	367.612.16.1	20	368.185.16.1	12
366.180.16.1	12	367.130.16.1	11	367.614.16.1	19	368.189.16.1	12
366.280.16.1	14	367.135.16.1	11	367.615.16.1	10	368.285.16.1	14
366.330.16.1	13	367.159.16.1	12	367.616.16.1	10	368.335.16.1	13
366.380.16.1	14	367.162.16.1	12	367.673.00.1	114	368.385.16.1	14
366.451.16.1	19	367.163.16.1	12	367.674.00.1	114	368.451.16.1	19
366.550.16.1	24	367.165.16.1	12	367.700.16.1	21	368.453.16.1	18
366.559.16.1	18	367.170.16.1	12	367.730.16.1	31	368.454.16.1	19
366.560.16.1	18	367.175.16.1	12	367.739.16.1	24	368.550.16.1	24
366.561.16.1	16	367.180.16.1	12	367.740.16.1	25	368.561.16.1	17
366.565.16.1	18	367.185.16.1	12	367.742.00.1	39	368.566.16.1	17
366.566.16.1	16	367.209.16.1	13	367.744.16.1	27	368.570.16.1	18
366.570.16.1	18	367.212.16.1	13	367.745.00.1	27	368.571.16.1	17
366.571.16.1	16	367.235.16.1	13	367.748.00.1	27	368.575.16.1	18
366.575.16.1	18	367.262.16.1	14	367.750.16.1	25	368.576.16.1	17
366.576.16.1	16	367.265.16.1	14	367.771.16.1	21	368.580.16.1	18
366.605.16.1	14	367.270.16.1	14	367.772.16.1	28	368.581.16.1	17
366.673.00.1	114	367.275.16.1	14	367.776.16.1	34	368.584.16.1	17
366.674.00.1	114	367.280.16.1	14	367.779.16.3	22	368.585.16.1	18
366.700.16.1	21	367.285.16.1	14	367.781.16.1	38	368.586.16.1	17
366.730.16.1	31	367.315.16.1	13	367.792.16.1	29	368.600.16.1	15
366.740.16.1	25	367.320.16.1	13	367.802.92.1	38	368.605.16.1	14
366.742.00.1	39	367.325.16.1	13	367.812.16.1	38	368.610.16.1	15

Cod articol	Pagină	Cod articol	Pagină	Cod articol	Pagină	Cod articol	Pagină
368.673.00.1	114	369.748.00.1	27	371.139.16.1	11	372.745.00.1	27
368.674.00.1	114	369.771.16.1	21	371.145.16.1	11	372.748.00.1	27
368.700.16.1	21	369.776.16.1	34	371.146.16.1	11	372.751.16.1	34
368.739.16.1	24	369.779.16.3	22	371.147.16.1	11	372.775.16.1	21
368.742.00.1	39	369.802.92.1	38	371.185.16.1	13	372.776.16.1	34
368.744.16.1	27	369.812.16.1	38	371.189.16.1	13	372.840.00.1	33
368.745.00.1	27	369.832.00.2	33	371.195.16.1	13	372.841.00.1	33
368.748.00.1	27	369.841.00.2	32	371.196.16.1	13	372.850.00.1	37
368.771.16.1	21	369.842.00.1	33	371.197.16.1	13	372.861.00.1	59
368.776.16.1	34	369.843.00.2	32	371.454.16.1	19	372.862.00.1	59
368.779.16.3	22	369.850.00.1	37	371.550.16.1	24	379.000.16.0	8
368.802.92.1	38	369.861.00.1	57	371.596.16.1	17	379.055.16.1	9
368.812.16.1	38	369.989.16.2	20	371.700.16.1	21	379.108.16.1	11
368.832.00.2	33	370.000.16.0	8	371.738.16.1	23	379.158.16.1	12
368.841.00.2	32	370.015.16.1	9	371.739.16.1	24	379.740.16.1	24
368.842.00.1	33	370.030.16.1	9	371.742.00.1	39	379.750.16.1	25
368.843.00.2	32	370.045.16.1	8	371.743.26.1	28	379.768.16.3	30
368.850.00.1	37	370.050.16.0	8	371.744.16.1	27	379.772.16.1	28
368.861.00.1	57	370.055.16.1	9	371.745.00.1	27	379.781.16.1	38
368.989.16.2	20	370.125.16.1	11	371.748.00.1	27	379.791.16.1	21
369.000.16.0	8	370.135.16.1	11	371.751.16.1	34	379.812.16.1	38
369.001.16.1	20	370.139.16.1	11	371.775.16.1	21	388.021.00.1	119
369.045.16.1	8	370.145.16.1	11	371.776.16.1	34	388.022.00.1	119
369.055.16.1	9	370.146.16.1	11	371.840.00.1	33	388.023.00.1	118
369.088.16.1	9	370.180.16.1	12	371.841.00.1	33	388.032.00.1	120
369.125.16.1	11	370.185.16.1	12	371.850.00.1	37	388.033.00.1	120
369.130.16.1	11	370.189.16.1	12	371.861.00.1	59	388.100.00.1	122
369.135.16.1	11	370.195.16.1	12	371.862.00.1	59	388.101.00.1	122
369.139.16.1	11	370.196.16.1	13	372.000.16.0	8	388.102.00.1	122
369.145.16.1	11	370.454.16.1	19	372.015.16.1	9	388.105.00.1	121
369.175.16.1	12	370.550.16.1	24	372.030.16.1	9	388.106.00.1	123
369.185.16.1	12	370.584.16.5	17	372.045.16.1	9	388.107.00.1	122
369.189.16.1	12	370.587.16.5	17	372.050.16.0	8	388.108.00.1	122
369.195.16.1	12	370.594.16.5	17	372.055.16.1	9	388.109.00.1	123
369.285.16.1	14	370.700.16.1	21	372.135.16.1	11	388.123.24.1	118
369.335.16.1	13	370.738.16.1	23	372.139.16.1	11	388.124.28.1	118
369.385.16.1	14	370.739.16.1	24	372.145.16.1	11	388.129.00.1	123
369.451.16.1	19	370.742.00.1	39	372.146.16.1	11	388.132.00.1	121
369.453.16.1	18	370.744.16.1	27	372.147.16.1	11	388.133.00.1	121
369.454.16.1	19	370.745.00.1	27	372.148.16.1	11	388.134.00.1	121
369.535.16.1	18	370.748.00.1	27	372.185.16.1	13	390.000.14.1	84
369.550.16.1	24	370.751.16.1	34	372.189.16.1	13	390.001.14.1	84
369.551.16.1	24	370.775.16.1	21	372.195.16.1	13	390.002.14.1	84
369.584.16.1	17	370.776.16.1	34	372.196.16.1	13	390.004.14.1	84
369.586.16.1	17	370.812.16.1	38	372.197.16.1	13	390.005.14.1	84
369.587.16.1	17	370.840.00.1	33	372.198.16.1	13	390.006.14.1	84
369.588.16.1	17	370.841.00.1	33	372.454.16.1	19	390.007.14.1	84
369.591.16.1	17	370.850.00.1	37	372.550.16.1	24	390.008.14.1	93
369.605.16.1	14	370.861.26.1	58	372.596.16.1	17	390.010.14.1	85
369.610.16.1	15	371.000.16.0	8	372.598.16.1	17	390.011.14.1	85
369.700.16.1	21	371.015.16.1	9	372.700.16.1	21	390.012.14.1	85
369.739.16.1	24	371.030.16.1	9	372.738.16.1	23	390.013.14.1	85
369.742.00.1	39	371.045.16.1	9	372.739.16.1	24	390.014.14.1	85
369.743.26.1	28	371.050.16.0	8	372.742.00.1	39	390.016.14.1	93
369.744.16.1	27	371.055.16.1	9	372.743.26.1	28	390.017.14.1	93
369.745.00.1	27	371.135.16.1	11	372.744.16.1	27	390.020.14.1	86



Cod articol	Pagină	Cod articol	Pagină	Cod articol	Pagină	Cod articol	Pagină
390.021.14.1	86	390.218.14.1	92	390.349.14.1	88	390.501.14.1	84
390.022.14.1	86	390.220.14.1	86	390.372.14.1	91	390.502.14.1	84
390.023.14.1	86	390.221.14.1	86	390.373.14.1	90	390.503.14.1	92
390.024.14.1	86	390.222.14.1	86	390.395.14.1	94	390.504.14.1	84
390.030.14.1	87	390.223.14.1	86	390.396.14.1	76	390.505.14.1	84
390.046.14.1	88	390.224.14.1	86	390.398.26.1	97	390.506.14.1	84
390.080.14.1	96	390.225.14.1	91	390.399.26.1	97	390.507.14.1	84
390.083.14.1	94	390.227.14.1	92	390.400.14.1	84	390.508.14.1	93
390.098.26.1	97	390.228.14.1	97	390.401.14.1	84	390.510.14.1	85
390.099.26.1	96	390.230.14.1	87	390.402.14.1	84	390.511.14.1	85
390.100.14.1	84	390.231.14.1	87	390.404.14.1	84	390.512.14.1	85
390.101.14.1	84	390.232.14.1	87	390.405.14.1	84	390.513.14.1	85
390.102.14.1	84	390.247.14.1	88	390.406.14.1	84	390.514.14.1	85
390.104.14.1	84	390.248.14.1	88	390.407.14.1	84	390.516.14.1	93
390.105.14.1	84	390.271.14.1	91	390.408.14.1	93	390.517.14.1	93
390.106.14.1	84	390.278.14.1	91	390.410.14.1	85	390.518.14.1	92
390.107.14.1	84	390.279.14.1	91	390.411.14.1	85	390.520.14.1	86
390.108.14.1	93	390.281.14.1	96	390.412.14.1	85	390.521.14.1	86
390.110.14.1	85	390.283.14.1	94	390.413.14.1	85	390.522.14.1	86
390.111.14.1	85	390.284.14.1	94	390.414.14.1	85	390.523.14.1	86
390.112.14.1	85	390.286.14.1	95	390.416.14.1	93	390.524.14.1	86
390.113.14.1	85	390.287.14.1	95	390.417.14.1	93	390.527.14.1	92
390.114.14.1	85	390.289.14.1	95	390.418.14.1	92	390.528.14.1	97
390.116.14.1	93	390.295.14.1	94	390.420.14.1	86	390.531.14.1	87
390.117.14.1	93	390.296.14.1	76	390.421.14.1	86	390.532.14.1	87
390.118.14.1	92	390.298.26.1	97	390.422.14.1	86	390.533.14.1	87
390.120.14.1	86	390.299.26.1	96	390.423.14.1	86	390.534.14.1	87
390.121.14.1	86	390.300.14.1	84	390.424.14.1	86	390.535.14.1	87
390.122.14.1	86	390.301.14.1	84	390.427.14.1	92	390.547.14.1	88
390.123.14.1	86	390.302.14.1	84	390.428.14.1	97	390.548.14.1	88
390.124.14.1	86	390.304.14.1	84	390.432.14.1	87	390.549.14.1	88
390.128.14.1	97	390.305.14.1	84	390.433.14.1	87	390.554.14.1	87
390.130.14.1	87	390.306.14.1	84	390.434.14.1	87	390.555.14.1	87
390.131.14.1	87	390.307.14.1	84	390.448.14.1	88	390.556.14.1	89
390.147.14.1	88	390.308.14.1	93	390.449.14.1	88	390.557.14.1	90
390.179.14.1	91	390.310.14.1	85	390.454.14.1	87	390.558.14.1	89
390.180.14.1	96	390.311.14.1	85	390.456.14.1	89	390.559.14.1	89
390.183.14.1	94	390.312.14.1	85	390.457.14.1	90	390.560.14.1	89
390.186.14.1	95	390.313.14.1	85	390.459.14.1	89	390.561.14.1	89
390.198.26.1	97	390.314.14.1	85	390.462.14.1	89	390.562.14.1	89
390.199.26.1	96	390.316.14.1	93	390.463.14.1	90	390.563.14.1	90
390.200.14.1	84	390.317.14.1	93	390.464.14.1	90	390.564.14.1	90
390.201.14.1	84	390.318.14.1	92	390.466.14.1	88	390.565.14.1	89
390.202.14.1	84	390.320.14.1	86	390.469.14.1	87	390.566.14.1	88
390.203.14.1	93	390.321.14.1	86	390.470.14.1	89	390.567.14.1	88
390.204.14.1	84	390.322.14.1	86	390.471.14.1	91	390.569.14.1	87
390.205.14.1	84	390.323.14.1	86	390.472.14.1	91	390.570.14.1	89
390.206.14.1	84	390.324.14.1	86	390.473.14.1	91	390.571.14.1	91
390.207.14.1	84	390.325.14.1	91	390.474.14.1	90	390.572.14.1	91
390.210.14.1	85	390.327.14.1	92	390.475.14.1	90	390.573.14.1	91
390.211.14.1	85	390.328.14.1	97	390.493.11.1	96	390.574.14.1	91
390.212.14.1	85	390.331.14.1	87	390.495.14.1	94	390.575.14.1	90
390.213.14.1	85	390.332.14.1	87	390.496.14.1	76	390.576.14.1	90
390.214.14.1	85	390.333.14.1	87	390.498.26.1	97	390.577.14.1	90
390.216.14.1	93	390.347.14.1	88	390.499.26.1	97	390.578.14.1	89
390.217.14.1	93	390.348.14.1	88	390.500.14.1	84	390.592.11.1	96

Cod articol	Pagină	Cod articol	Pagină	Cod articol	Pagină	Cod articol	Pagină
390.593.11.1	96	390.723.14.1	86	601.733.00.1	155	619.121.00.1	129
390.595.14.1	94	390.724.14.1	86	601.736.00.1	155	619.122.00.1	129
390.596.14.1	76	390.727.14.1	92	601.737.00.1	155	619.123.00.1	129
390.598.26.1	97	390.728.14.1	97	601.738.00.1	155	619.130.00.1	130
390.599.26.1	97	390.735.14.1	87	601.741.00.1	156	619.131.00.1	130
390.600.14.1	84	390.736.14.1	87	601.801.00.1	152	619.133.00.1	130
390.601.14.1	84	390.737.14.1	87	601.802.00.1	152	619.135.00.2	130
390.602.14.1	84	390.751.14.1	88	601.806.00.1	152	619.140.00.1	129
390.603.14.1	92	390.752.14.1	88	601.813.00.1	152	619.141.00.1	129
390.604.14.1	84	390.753.14.1	88	601.815.00.1	152	619.142.00.1	129
390.605.14.1	84	390.775.14.1	91	601.851.26.1	153	619.143.00.1	129
390.606.14.1	84	390.776.14.1	91	601.852.26.1	153	619.150.00.1	131
390.607.14.1	84	390.796.14.1	76	601.853.26.1	153	619.151.00.1	131
390.608.14.1	93	390.799.26.1	97	601.854.26.1	153	619.152.00.1	131
390.610.14.1	85	393.525.14.1	102	601.855.26.1	153	619.160.00.1	129
390.611.14.1	85	393.526.14.1	102	601.856.26.1	153	619.161.00.1	129
390.612.14.1	85	393.540.14.1	102	601.857.26.1	198	619.162.00.1	129
390.613.14.1	85	393.541.14.1	102	601.858.26.1	153	619.170.00.1	131
390.614.14.1	85	393.544.14.1	102	601.859.26.1	153	619.171.00.1	131
390.616.14.1	93	393.545.14.1	102	601.860.26.1	199	619.172.00.1	131
390.617.14.1	93	465.034.00.2	149	601.861.26.1	199	619.180.00.1	131
390.618.14.1	92	600.041.00.1	157	617.170.00.1	131	619.181.00.1	131
390.620.14.1	86	600.042.00.1	157	617.171.00.1	131	619.182.00.1	131
390.621.14.1	86	600.043.00.1	157	617.180.00.1	131	619.220.00.1	129
390.622.14.1	86	600.044.00.1	157	617.181.00.1	131	619.221.00.1	129
390.623.14.1	86	600.045.00.1	157	617.190.00.1	131	619.260.22.1	151
390.624.14.1	86	600.046.00.1	157	619.010.00.1	128	619.261.22.1	151
390.627.14.1	92	600.047.00.1	157	619.011.00.1	128	619.471.22.1	151
390.628.14.1	97	600.048.00.1	157	619.012.00.1	128	619.472.22.1	151
390.634.14.1	87	600.049.00.1	157	619.013.00.1	128	619.481.22.1	151
390.635.14.1	87	600.051.00.1	157	619.014.00.1	128	619.482.22.1	151
390.636.14.1	87	600.052.00.1	157	619.015.00.1	128	619.490.22.1	151
390.650.14.1	88	600.053.00.1	157	619.016.00.1	128	619.491.22.1	151
390.651.14.1	88	600.054.00.1	157	619.020.00.1	128	619.492.22.1	151
390.652.14.1	88	600.055.00.1	157	619.021.00.1	128	619.616.00.1	146
390.662.14.1	89	600.056.00.1	157	619.022.00.1	128	619.617.00.1	147
390.665.14.1	88	600.057.00.1	157	619.023.00.1	128	619.700.00.1	138
390.675.14.1	91	600.058.00.1	157	619.024.00.1	128	619.701.00.1	138
390.695.14.1	94	600.059.00.1	157	619.025.00.1	128	619.702.00.1	138
390.696.14.1	76	600.079.00.1	203	619.026.00.1	128	619.703.00.1	138
390.699.26.1	97	600.080.00.1	203	619.027.00.1	128	619.704.00.1	138
390.700.14.1	84	600.081.00.1	203	619.050.00.1	128	619.705.00.1	138
390.701.14.1	84	600.082.00.1	203	619.051.00.1	128	619.706.00.1	138
390.702.14.1	84	600.083.00.1	203	619.052.00.1	128	619.720.00.1	153
390.703.14.1	92	600.084.00.1	203	619.054.00.1	128	619.721.00.1	153
390.704.14.1	84	600.085.00.1	203	619.060.00.1	128	619.722.00.1	153
390.705.14.1	84	600.087.00.1	203	619.061.00.1	128	619.730.00.1	153
390.706.14.1	84	600.088.00.1	203	619.070.00.1	128	619.731.00.1	153
390.707.14.1	84	600.089.00.1	203	619.100.00.1	129	619.732.00.1	153
390.708.14.1	93	600.090.00.1	203	619.101.00.1	129	619.733.00.1	153
390.716.14.1	93	600.091.00.1	203	619.102.00.1	129	619.734.00.1	153
390.717.14.1	93	600.092.00.1	203	619.103.00.1	129	619.735.00.1	153
390.718.14.1	92	600.093.00.1	203	619.110.00.1	130	619.736.00.1	153
390.720.14.1	86	600.094.00.1	203	619.111.00.1	130	619.737.00.1	153
390.721.14.1	86	601.731.00.1	156	619.112.00.1	130	620.003.00.1	133
390.722.14.1	86	601.732.00.1	156	619.120.00.1	129	620.010.00.1	132



Cod articol	Pagină	Cod articol	Pagină	Cod articol	Pagină	Cod articol	Pagină
620.011.00.1	132	620.095.00.1	136	620.231.00.1	136	620.382.00.1	141
620.012.00.1	132	620.096.00.1	136	620.232.00.1	136	620.391.00.1	141
620.013.00.1	132	620.097.00.1	136	620.233.00.1	136	620.392.00.1	141
620.014.00.1	132	620.100.00.1	134	620.234.00.1	136	620.400.00.1	139
620.015.00.1	132	620.101.00.1	134	620.235.00.1	136	620.401.00.1	139
620.016.00.1	132	620.102.00.1	134	620.236.00.1	136	620.402.00.1	139
620.017.00.1	132	620.103.00.1	134	620.240.00.1	136	620.403.00.1	139
620.020.00.1	132	620.104.00.1	134	620.241.00.1	136	620.404.00.1	139
620.021.00.1	132	620.105.00.1	134	620.242.00.1	136	620.405.00.1	139
620.022.00.1	132	620.106.00.1	134	620.250.00.1	136	620.406.00.1	139
620.023.00.1	132	620.107.00.1	134	620.252.00.1	136	620.407.00.1	139
620.024.00.1	132	620.108.00.1	134	620.253.00.1	137	620.410.00.1	139
620.025.00.1	132	620.111.00.1	134	620.254.00.1	137	620.411.00.1	139
620.031.00.1	133	620.112.00.1	134	620.255.00.1	137	620.412.00.1	139
620.032.00.1	133	620.113.00.1	134	620.256.00.1	137	620.413.00.1	139
620.033.00.1	133	620.114.00.1	134	620.257.00.1	137	620.414.00.1	139
620.034.00.1	133	620.115.00.1	134	620.290.00.1	140	620.415.00.1	139
620.035.00.1	133	620.116.00.1	134	620.291.00.1	140	620.416.00.1	139
620.036.00.1	133	620.117.00.1	134	620.300.00.1	138	620.420.00.1	139
620.037.00.1	133	620.121.00.1	134	620.301.00.1	138	620.421.00.1	139
620.042.00.1	133	620.122.00.1	134	620.302.00.1	138	620.424.00.1	139
620.043.00.1	133	620.123.00.1	134	620.303.00.1	138	620.490.00.1	141
620.044.00.1	133	620.124.00.1	134	620.304.00.1	138	620.491.00.1	141
620.045.00.1	133	620.125.00.1	134	620.305.00.1	138	620.502.00.1	139
620.046.00.1	133	620.126.00.1	134	620.306.00.1	138	620.503.00.1	139
620.047.00.1	133	620.127.00.1	135	620.307.00.1	138	620.504.00.1	139
620.054.00.1	133	620.131.00.1	134	620.308.00.1	138	620.505.00.1	139
620.057.00.1	133	620.132.00.1	134	620.309.00.1	138	620.506.00.1	139
620.061.00.1	133	620.133.00.1	134	620.310.00.1	138	620.510.00.1	139
620.062.00.1	133	620.135.00.1	134	620.311.00.1	138	620.511.00.1	139
620.063.00.1	133	620.136.00.1	134	620.312.00.1	138	620.512.00.1	139
620.064.00.1	133	620.137.00.1	135	620.313.00.1	138	620.520.00.1	139
620.065.00.1	133	620.142.00.1	134	620.314.00.1	138	620.521.00.1	139
620.066.00.1	133	620.143.00.1	134	620.315.00.1	138	620.522.00.1	140
620.067.00.1	133	620.147.00.1	135	620.316.00.1	138	620.523.00.1	140
620.070.00.1	133	620.150.00.1	135	620.320.00.1	138	620.524.00.1	140
620.071.00.1	133	620.151.00.1	135	620.321.00.1	138	620.525.00.1	140
620.072.00.1	133	620.152.00.1	135	620.322.00.1	138	620.526.00.1	140
620.073.00.1	133	620.153.00.1	135	620.324.00.1	138	620.527.00.1	140
620.074.00.1	133	620.154.00.1	135	620.329.00.1	137	620.528.00.1	140
620.075.00.1	133	620.155.00.1	135	620.330.00.1	150	620.532.00.1	140
620.076.00.1	133	620.156.00.1	135	620.331.00.1	150	620.533.00.1	140
620.077.00.1	133	620.157.00.1	135	620.332.00.1	137	620.534.00.1	140
620.080.00.1	134	620.162.00.1	135	620.333.00.1	137	620.535.00.1	140
620.081.00.1	134	620.163.00.1	135	620.334.00.1	137	620.536.00.1	140
620.082.00.1	134	620.164.00.1	135	620.335.00.1	137	620.540.00.1	140
620.083.00.1	134	620.165.00.1	135	620.336.00.1	137	620.541.00.1	140
620.084.00.1	134	620.166.00.1	135	620.337.00.1	137	620.542.00.1	140
620.085.00.1	134	620.173.00.1	135	620.338.00.1	137	620.550.00.1	140
620.086.00.1	134	620.174.00.1	135	620.339.00.1	137	620.551.00.1	140
620.087.00.1	134	620.175.00.1	135	620.347.00.1	137	620.560.00.1	142
620.090.00.1	136	620.176.00.1	135	620.353.00.1	135	620.561.00.1	142
620.091.00.1	136	620.177.00.1	135	620.354.00.1	135	620.562.00.1	142
620.092.00.1	136	620.184.00.1	135	620.355.00.1	135	620.570.00.1	142
620.093.00.1	136	620.185.00.1	135	620.380.00.1	141	620.571.00.1	142
620.094.00.1	136	620.230.00.1	136	620.381.00.1	141	620.572.00.1	142

Cod articol	Pagină	Cod articol	Pagină	Cod articol	Pagină	Cod articol	Pagină
620.573.00.1	142	620.663.00.1	144	620.841.00.1	148	652.480.00.1	165
620.574.00.1	142	620.664.00.1	144	620.842.00.1	148	652.481.00.1	165
620.575.00.1	142	620.665.00.1	144	620.851.00.1	148	652.520.00.1	166
620.576.00.1	142	620.671.00.1	144	620.852.00.1	148	652.521.00.1	166
620.580.00.1	142	620.672.00.1	144	620.881.00.1	149	652.522.00.1	166
620.581.00.1	142	620.673.00.1	144	620.921.00.1	149	652.523.00.1	166
620.582.00.1	142	620.674.00.1	144	620.951.00.1	149	652.524.00.1	166
620.583.00.1	142	620.675.00.1	144	620.981.00.1	149	652.525.00.1	166
620.584.00.1	142	620.680.00.1	145	650.921.00.2	311	652.526.00.1	166
620.585.00.1	142	620.681.00.1	145	651.420.00.1	170	652.527.00.1	166
620.586.00.1	142	620.683.00.1	145	651.422.00.1	170	652.528.00.1	166
620.591.00.1	142	620.684.00.1	145	651.423.00.1	170	652.529.00.1	166
620.593.00.1	142	620.685.00.1	145	651.424.00.1	170	652.530.00.1	166
620.594.00.1	142	620.686.00.1	145	651.425.00.1	171	652.531.00.1	173
620.595.00.1	142	620.688.00.1	145	651.426.00.1	171	653.940.26.1	311
620.596.00.1	142	620.689.00.1	145	651.427.00.1	171	654.940.26.1	311
620.600.00.1	143	620.690.00.1	145	651.428.00.1	171	655.078.00.1	308
620.601.00.1	143	620.691.00.1	145	651.432.00.1	172	655.079.00.1	309
620.602.00.1	143	620.693.00.1	145	651.436.00.1	172	655.081.00.1	314
620.603.00.1	143	620.694.00.1	145	651.437.00.1	172	655.082.00.1	314
620.604.00.1	143	620.695.00.1	144	651.438.00.1	172	655.083.00.1	315
620.605.00.1	143	620.700.00.1	145	651.440.00.1	173	655.084.00.1	309
620.606.00.1	143	620.701.00.1	145	651.761.00.1	163	655.085.00.1	315
620.613.00.1	143	620.703.00.1	137	651.810.00.1	163	655.086.00.1	315
620.614.00.1	143	620.710.00.1	145	651.811.00.1	163	655.104.00.1	313
620.615.00.1	143	620.711.00.1	137	651.812.00.1	164	655.940.26.1	311
620.620.00.1	144	620.712.00.1	137	651.822.00.1	163	656.940.26.1	311
620.621.00.1	144	620.720.00.1	146	651.824.00.1	164	657.940.26.1	311
620.622.00.1	144	620.721.00.1	146	651.827.00.1	162	658.940.26.1	311
620.623.00.1	144	620.722.00.1	146	651.828.00.1	164	659.940.26.1	311
620.624.00.1	144	620.723.00.1	137	651.829.00.1	164	690.017.00.1	328
620.625.00.1	144	620.724.00.1	137	652.401.00.1	171	690.019.00.1	328
620.626.00.1	144	620.727.00.1	137	652.413.22.1	169	690.102.00.1	40
620.630.00.1	144	620.730.00.1	146	652.414.22.1	169	690.112.00.1	310
620.631.00.1	144	620.731.00.1	146	652.415.22.1	170	690.115.00.1	310
620.632.00.1	144	620.732.00.1	146	652.416.22.1	169	690.121.00.1	319
620.633.00.1	144	620.740.00.1	147	652.417.22.1	166	690.122.00.1	319
620.634.00.1	144	620.741.00.1	147	652.418.22.1	166	690.123.00.1	319
620.635.00.1	144	620.742.00.1	147	652.419.22.1	167	690.124.00.1	319
620.636.00.1	144	620.750.00.1	148	652.420.00.1	167	690.125.00.1	319
620.640.00.1	144	620.751.00.1	148	652.425.22.1	167	690.126.00.1	319
620.641.00.1	144	620.760.00.1	148	652.427.22.1	167	690.190.00.1	319
620.642.00.1	144	620.761.00.1	148	652.430.22.1	168	690.192.00.1	319
620.643.00.1	144	620.770.00.1	148	652.431.22.1	168	690.221.00.1	320
620.644.00.1	144	620.771.00.1	148	652.432.22.1	167	690.222.00.1	320
620.645.00.1	144	620.780.00.1	141	652.433.22.1	168	690.223.00.1	320
620.646.00.1	144	620.781.00.1	141	652.436.22.1	168	690.224.00.1	320
620.650.00.1	144	620.800.00.1	148	652.470.00.1	165	690.225.00.1	320
620.651.00.1	144	620.801.00.1	148	652.471.00.1	165	690.226.00.1	320
620.652.00.1	144	620.802.00.1	148	652.472.00.1	165	690.230.00.1	320
620.653.00.1	144	620.810.00.1	148	652.473.00.1	165	690.232.00.1	320
620.654.00.1	144	620.811.00.1	148	652.474.00.1	165	690.300.00.1	310
620.655.00.1	144	620.821.00.1	148	652.476.00.1	165	690.301.00.1	310
620.656.00.1	144	620.830.00.1	148	652.477.00.1	165	690.310.00.1	310
620.661.00.1	144	620.831.00.1	148	652.478.00.1	165	690.311.00.1	310
620.662.00.1	144	620.832.00.1	148	652.479.00.1	165	690.312.00.1	311



Cod articol	Pagină
690.313.00.1	311
690.314.00.1	311
690.511.P2.1	330
690.512.00.2	329
690.514.00.2	331
690.598.P1.2	329
690.600.00.1	329
690.800.00.1	163
690.915.00.1	312
690.916.00.1	312
690.917.00.1	312
690.918.00.1	312
690.937.00.1	312
690.938.00.1	312
690.940.00.1	315
690.941.00.1	315
690.942.00.1	159
691.000.P2.3	324
691.017.P1.1	328
691.030.00.1	307
691.031.00.1	307
691.032.00.1	308
691.033.00.1	310
691.034.00.1	310
691.035.00.1	308
691.036.00.1	309
691.037.00.1	309
691.103.P2.1	330
691.106.00.1	327
691.113.P2.1	330
691.129.00.1	332
691.137.00.1	320
691.141.00.1	332
691.152.00.1	313
691.153.00.1	314
691.154.00.1	314
691.155.00.1	314
691.161.00.1	313
691.181.00.1	321
691.182.00.1	321
691.183.00.1	321
691.185.00.3	321
691.186.00.1	323
691.187.00.1	323
691.188.00.1	322
691.189.00.1	322
691.203.00.1	321
691.214.P2.1	330
691.218.P1.2	329
691.229.P1.2	331
691.296.00.2	321
853.650.16.1	39
953.761.00.1	40



Geberit SRL

Strada Izvor, nr.80, et.9
București
România

T +4 021 330 30 80
F +4 021 330 31 61
info.ro@geberit.com

www.geberit.ro